

This drawing is confidential and must not be reproduced or used without the consent of EXM

Ce dessin est confidentiel et ne doit pas être reproduit ou utilisé sans le consentement de EXM

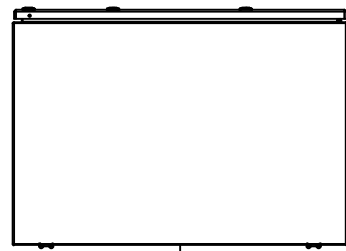

TOP

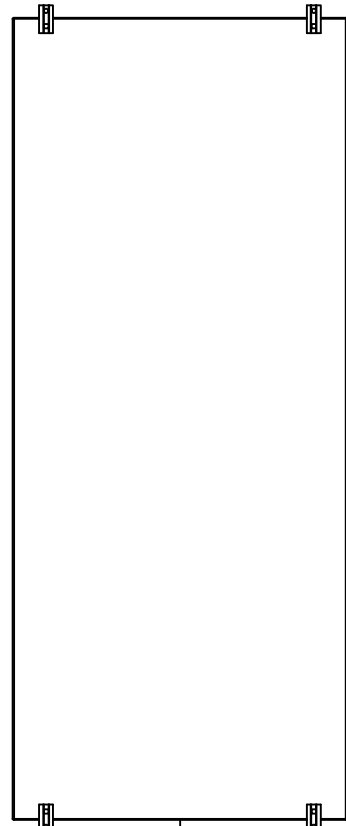

BACK

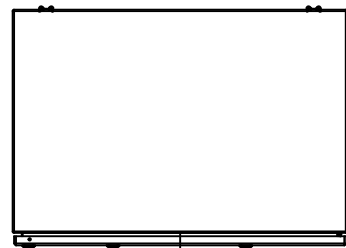

BOTTOM

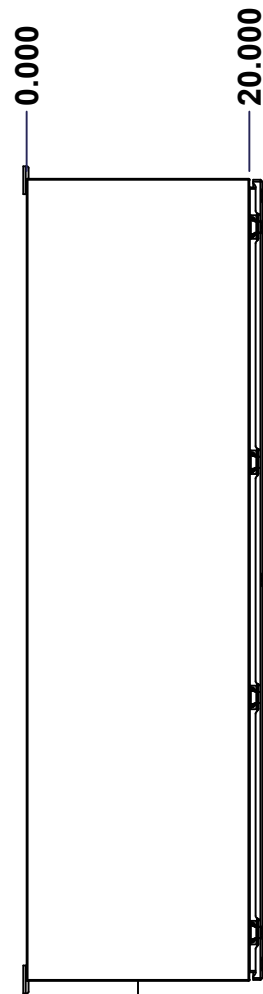

LEFT

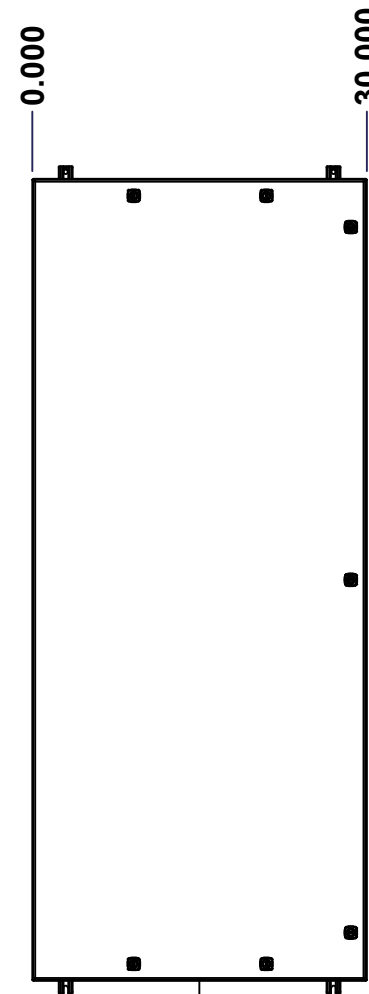

FRONT

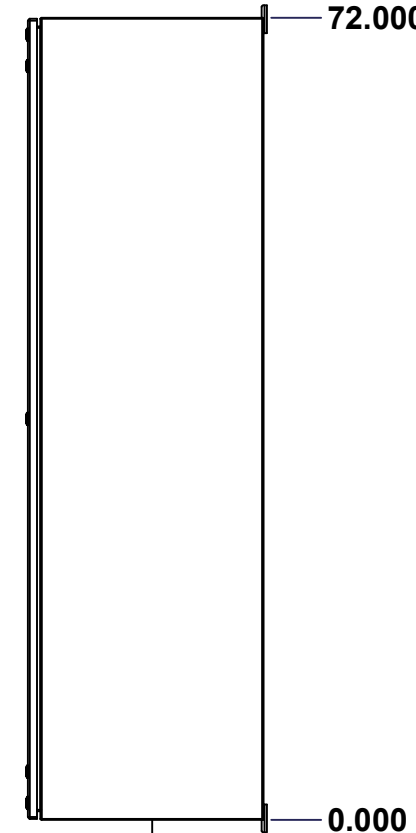

RIGHT

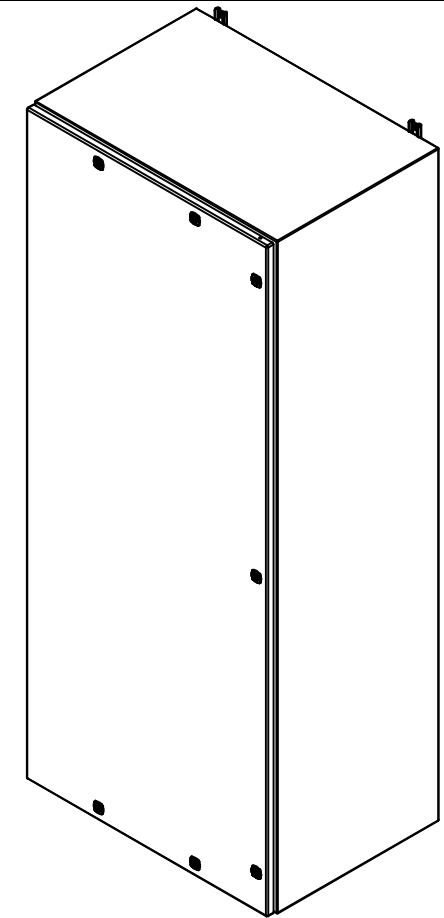

Isometric View

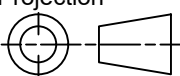

No.	Revisions	Date	By/Par

 Tél: (450) 979-4373 Fax: (450) 979-4626 www.exmweb.com		Flatness Aplatissement Max 3.0mm Projection 
Customer Client	Date	
Drawn By Dessiné Par	BoxCad: BoxCad	Date 12-Mar-25
Material Matière	14 Ga Cold Rolled A1008 CS Type B (1.7mm)	
Color Couleur	Asa-61 Grey	Finish Fini Smooth
Description	Detail Rev.	
5412ESPR 72" x 30" x 20" Assembly		
Part Number Numéro Pièce	Rev.	1
5412ESPR723020TH	0	16

SEE BILL OF MATERIAL ON LAST PAGE

This drawing is confidential and must not be reproduced or used without the consent of EXM

Ce dessin est confidentiel et ne doit pas être reproduit ou utilisé sans le consentement de EXM

NOTE	
ITEM	DESCRIPTION
1	NEMA 4, 12 Enclosure (IP66)
2	C/W Standard ground studs on box and cover
3	C/W Standard door stiffener
4	C/W Standard inner panel (Included)
5	C/W Standard inner panel mounting studs
6	C/W R5 Insulation (Installed aluminum visible)

No.	Revisions	Date	By/Par

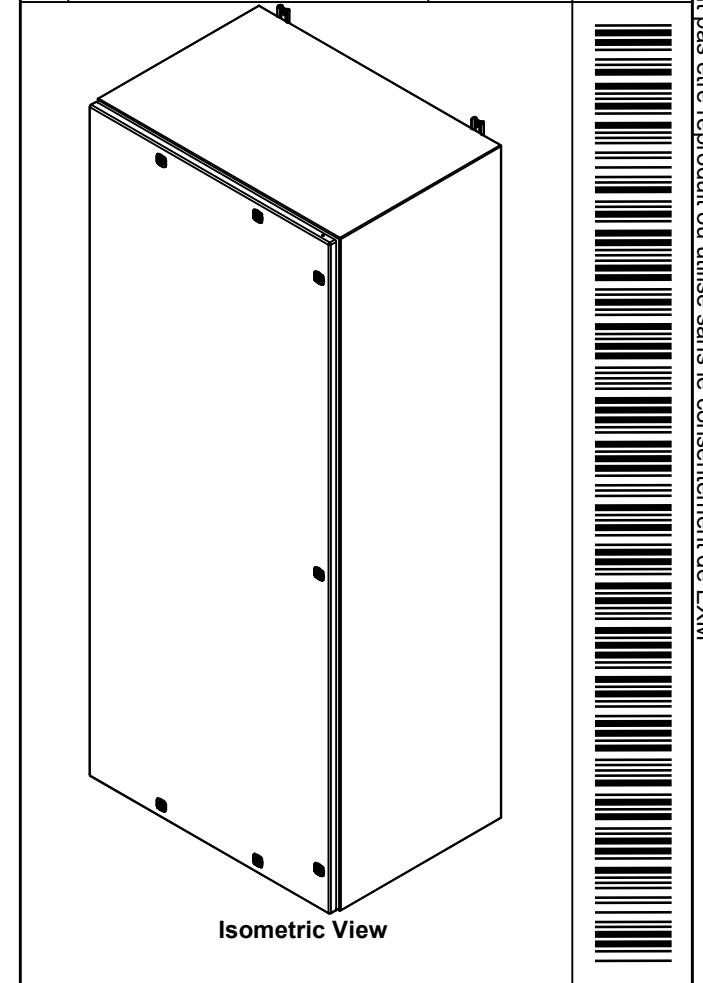

PACKING		
ITEM	QTY	DESCRIPTION
Cardboard sleeve	2	Top and Bottom
Cardboard strip	2	Between back of enclosure and inner panel
Plastic bag	1	To protect cover surface and inside gasket
Cardboard corner	4	To reinforced for the plastic strap tightening
Plastic strap - Black	2	To Squeeze the 2 cardboard sleeve together
Packaging label	3	White label with PN
Plastic strap- Green	2	To secure the enclosure to the wood pallet
Wood Pallet	1	2" deeper and 3" larger than enclosure size

Qty	Part Number	Rev	Description
6	STK-Q-00600	2	M12 to M8 Adaptor
1	881 SP7230G	0	881 SP - Inner Panel
1	STK-K-01800	5	5412 ES Accessory Kit
1	5412ESPR723020THC	0	5412ESPR 72" x 30" Cover
1	5412ESPR723020THB	0	5412ESPR 72" x 30" x 20" Body
8	STK-Q-04050-08	0	M6 x 8mm Hexagon Socket Head Machine Screw
Parts List			

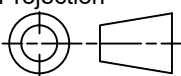
 Tél: (450) 979-4373 Fax: (450) 979-4626 www.exmweb.com		Flatness Aplatissement Max 3.0mm Projection 
Customer Client	Date	
Drawn By Dessiné Par	BoxCad: BoxCad	Date 12-Mar-25
Material Matière	14 Ga Cold Rolled A1008 CS Type B (1.7mm)	
Color Couleur	Asa-61 Grey	Finish Fini Smooth
Description		Detail Rev.
5412ESPR 72" x 30" x 20" Assembly		
Part Number Numéro Pièce	Rev.	2
5412ESPR723020TH	0	16

This drawing is confidential and must not be reproduced or used without the consent of EXM

Ce dessin est confidentiel et ne doit pas être reproduit ou utilisé sans le consentement de EXM

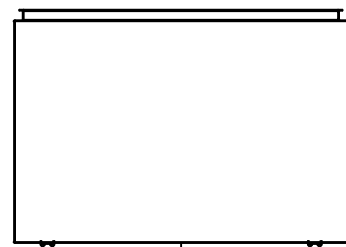

TOP



BACK

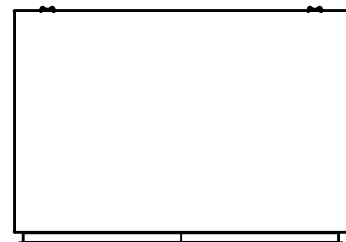

BOTTOM

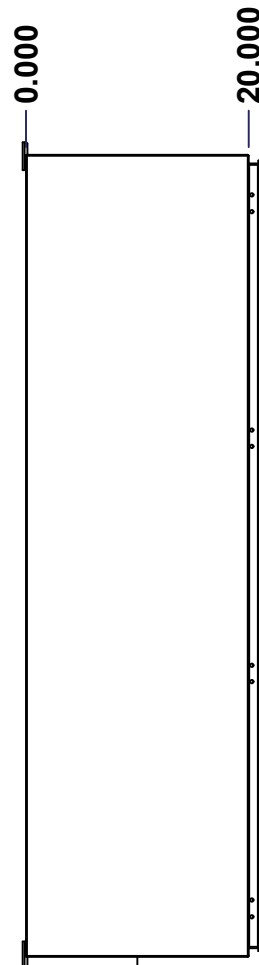

LEFT

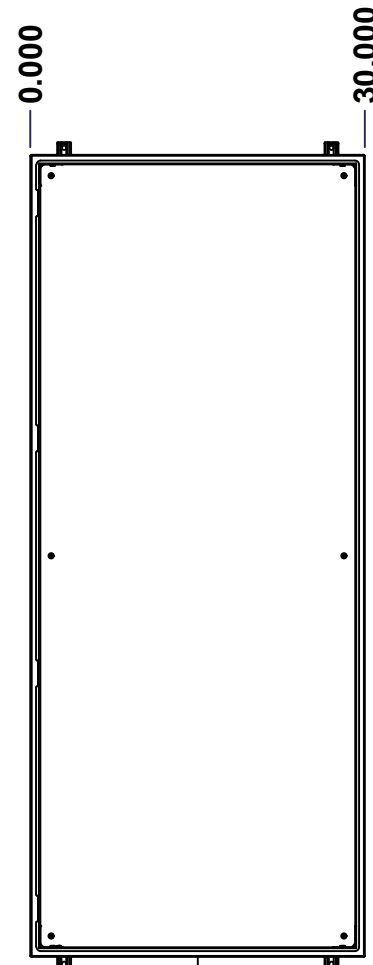

FRONT

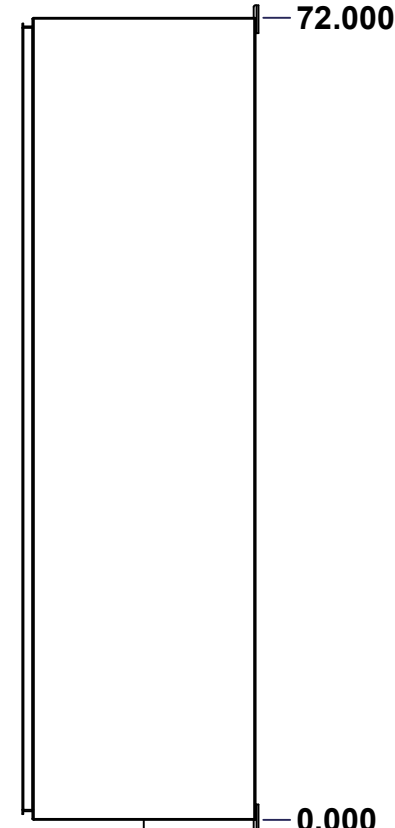

RIGHT

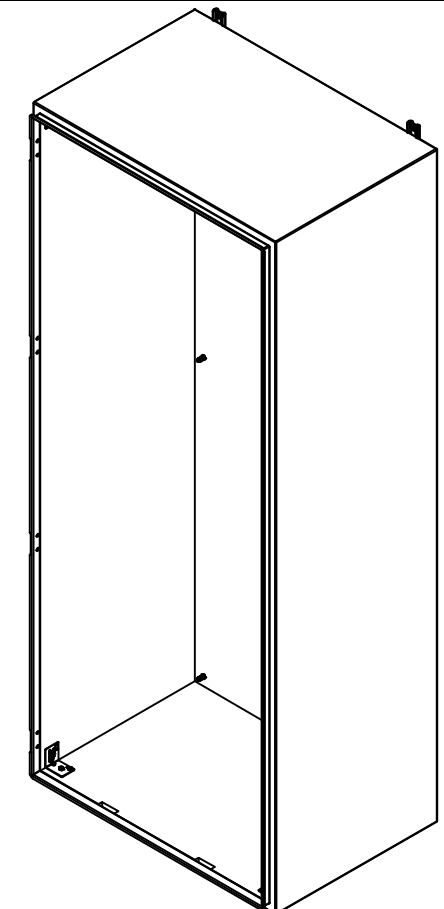

Isometric View

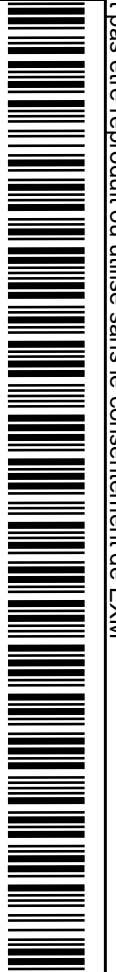

No.	Revisions	Date	By/Par

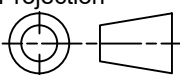
 Tél: (450) 979-4373 Fax: (450) 979-4626 www.exmweb.com		Flatness Aplatissement Max 3.0mm Projection 
Customer Client	Date	
Drawn By Dessiné Par	BoxCad: BoxCad	Date 12-Mar-25
Material Matière	14 Ga Cold Rolled A1008 CS Type B (1.7mm)	
Color Couleur	Asa-61 Grey	Finish Fini Smooth
Description	Detail Rev.	
5412ESPR 72" x 30" x 20" Body		
Part Number Numéro Pièce	Rev. 0	3 / 16

SEE BILL OF MATERIAL ON LAST PAGE

5412ESPR723020THB

This drawing is confidential and must not be reproduced or used without the consent of EXM

Ce dessin est confidentiel et ne doit pas être reproduit ou utilisé sans le consentement de EXM

STANDARD FEATURES ARE NOT LISTED IN THIS HOLE TABLE			
HOLE TABLE - TOP VIEW (CUSTOM FEATURE ONLY)			
CUT-OUT	XDIM	YDIM	DESCRIPTION
1	2.000	18.500	INSUL. STUD M6 x 18mm (Inside)
2	28.000	18.500	INSUL. STUD M6 x 18mm (Inside)

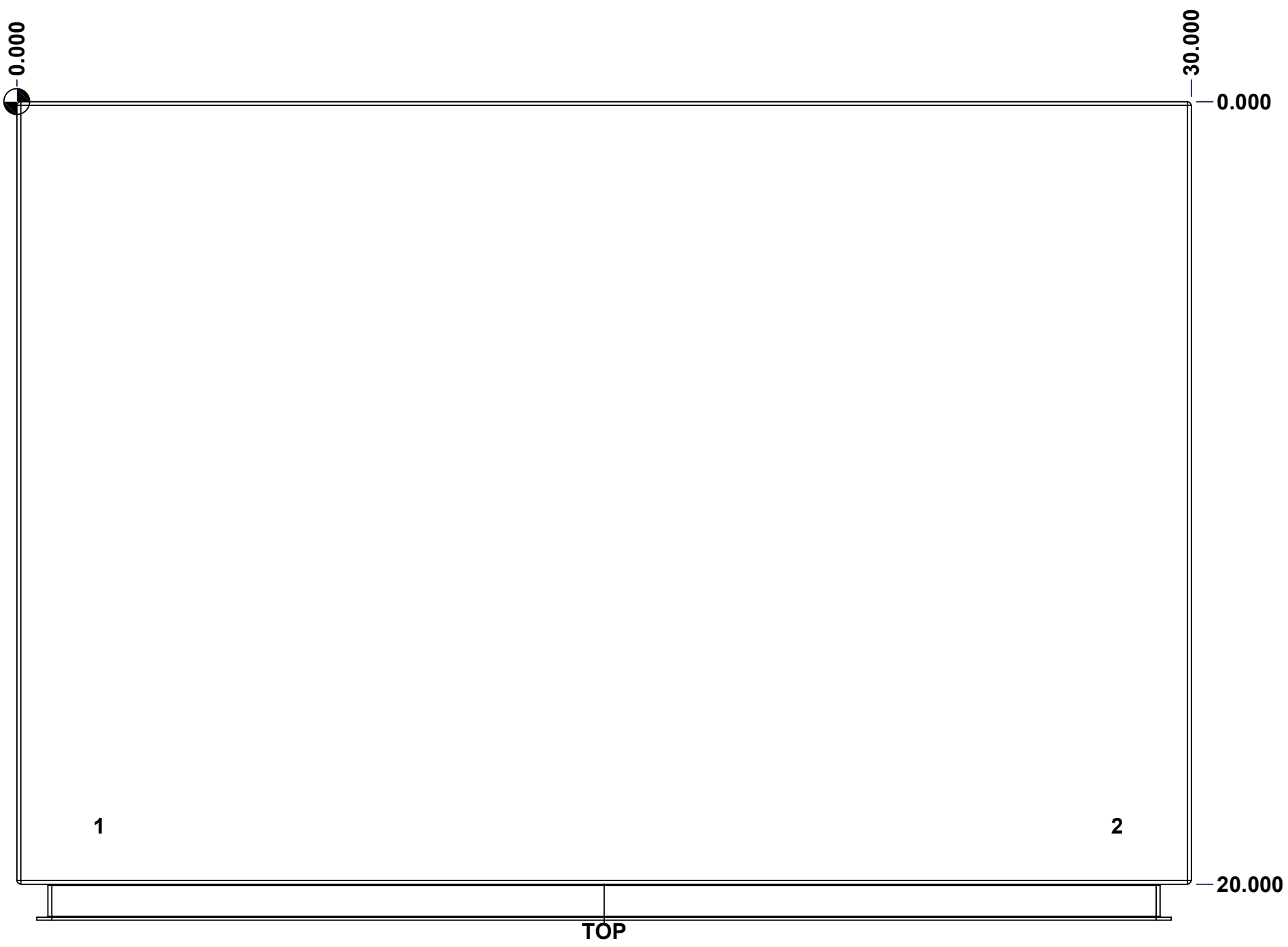

	Description	Status	
	5412ESPR 72" x 30" x 20" Body	(NULL)	
	Part Number Numéro Pièce	Rev.	4
	5412ESPR723020THB	0	16

This drawing is confidential and must not be reproduced or used without the consent of EXM

Ce dessin est confidentiel et ne doit pas être reproduit ou utilisé sans le consentement de EXM

STANDARD FEATURES ARE NOT LISTED IN THIS HOLE TABLE			
HOLE TABLE - BOTTOM VIEW (CUSTOM FEATURE ONLY)			
CUT-OUT	XDIM	YDIM	DESCRIPTION
1	2.000	18.500	INSUL. STUD M6 x 18mm (Inside)
2	28.000	18.500	INSUL. STUD M6 x 18mm (Inside)

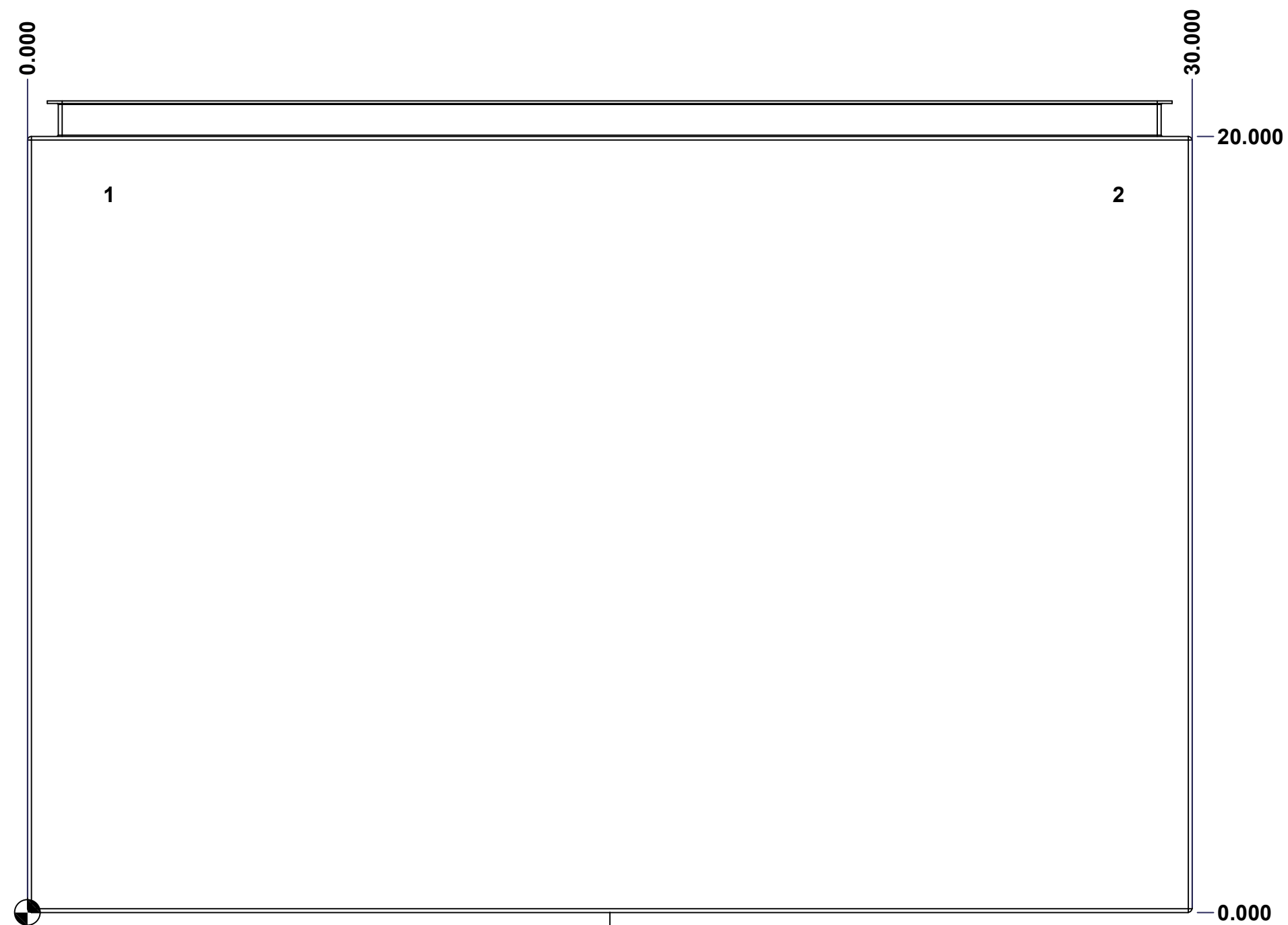

BOTTOM

	Description	Status
	5412ESPR 72" x 30" x 20" Body	(NULL)
Part Number Numéro Pièce	5412ESPR723020THB	Rev. 5
		0 / 16

This drawing is confidential and must not be reproduced or used without the consent of EXM

Ce dessin est confidentiel et ne doit pas être reproduit ou utilisé sans le consentement de EXM

STANDARD FEATURES ARE NOT LISTED IN THIS HOLE TABLE

HOLE TABLE - BACK VIEW (CUSTOM FEATURE ONLY)

CUT-OUT	XDIM	YDIM	DESCRIPTION
1	1.875	1.875	IP STUD M8 x 35mm (Inside)
2	1.875	70.125	IP STUD M8 x 35mm (Inside)
3	28.125	70.125	IP STUD M8 x 35mm (Inside)
4	28.125	1.875	IP STUD M8 x 35mm (Inside)
5	1.875	36.000	IP STUD M8 x 35mm (Inside)
6	28.125	36.000	IP STUD M8 x 35mm (Inside)

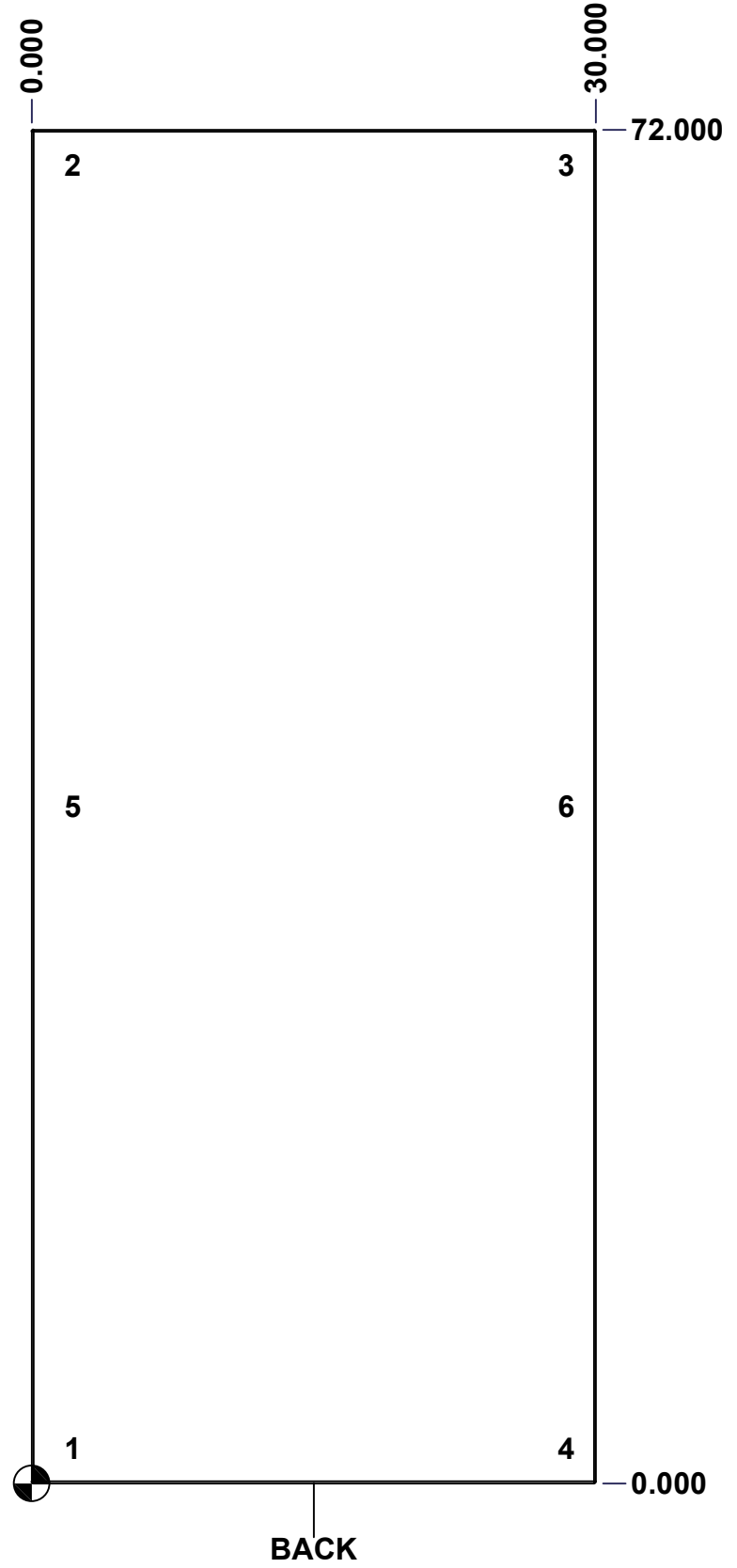

	Description	Status
	5412ESPR 72" x 30" x 20" Body	(NULL)
Part Number Numéro Pièce	5412ESPR723020THB	Rev. 6
		0
		16

This drawing is confidential and must not be reproduced or used without the consent of EXM

Ce dessin est confidentiel et ne doit pas être reproduit ou utilisé sans le consentement de EXM

No.	Revisions	Date	By/Par

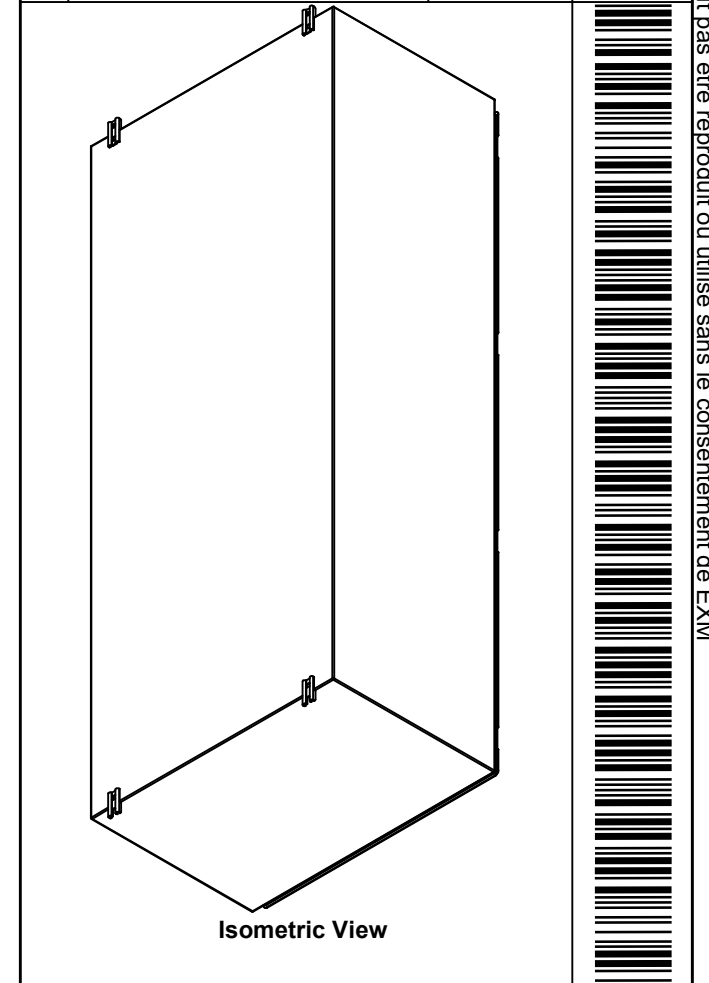

EXM
www.exmweb.com

Tél: (450) 979-4373
Fax: (450) 979-4626

Flatness
Aplatissement
Max 3.0mm

Projection

1	STK-K-70554	3	5412 ESTH Accessory Kit
1	5412ESPR723020THI-RS	0	5412ESPR 72" x 30" Right Insulation
1	5412ESPR723020THI-LS	0	5412ESPR 72" x 30" Left Insulation
1	5412ESPR723020THI-BT	0	5412ESPR 72" x 30"Bottom Insulation
1	5412ESPR723020THI-TP	0	5412ESPR 72" x 30"Top Insulation
1	5412ESPR723020THI-B	0	5412ESPR 72" x 30" Back Insulation
4	STK-Q-16055	1	M6 x 18mm Stud (No Paint Cap Required)
2	885ESMF3-FEET	0	885 ESMF3 Mounting Foot (Close)
2	885ESMF3-FEET-A	0	885 ESMF3 Mounting Foot (Open)
1	STK-P-02400S	0	Powder Paint (Asa-61 Grey / Smooth)
6	STK-Q-16005	0	Stud M8 x 35mm Steel
1	5412ESPR723020THB-P	0	5412ESPR 72" x 30" x 20" Body Part
Qty	Part Number	Rev	Description
Parts List			

Customer Client	Date
Drawn By Dessiné Par BoxCad: BoxCad	Date 12-Mar-25
Material Matière 14 Ga Cold Rolled A1008 CS Type B (1.7mm)	
Color Couleur Asa-61 Grey	Finish Fini Smooth
Description 5412ESPR 72" x 30" x 20" Body	Detail Rev.
Part Number Numéro Pièce 5412ESPR723020THB	Rev. 0

This drawing is confidential and must not be reproduced or used without the consent of EXM

Ce dessin est confidentiel et ne doit pas être reproduit ou utilisé sans le consentement de EXM

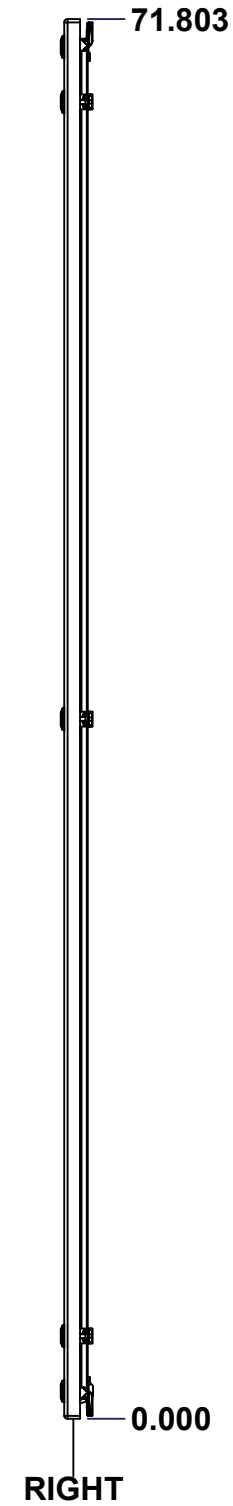
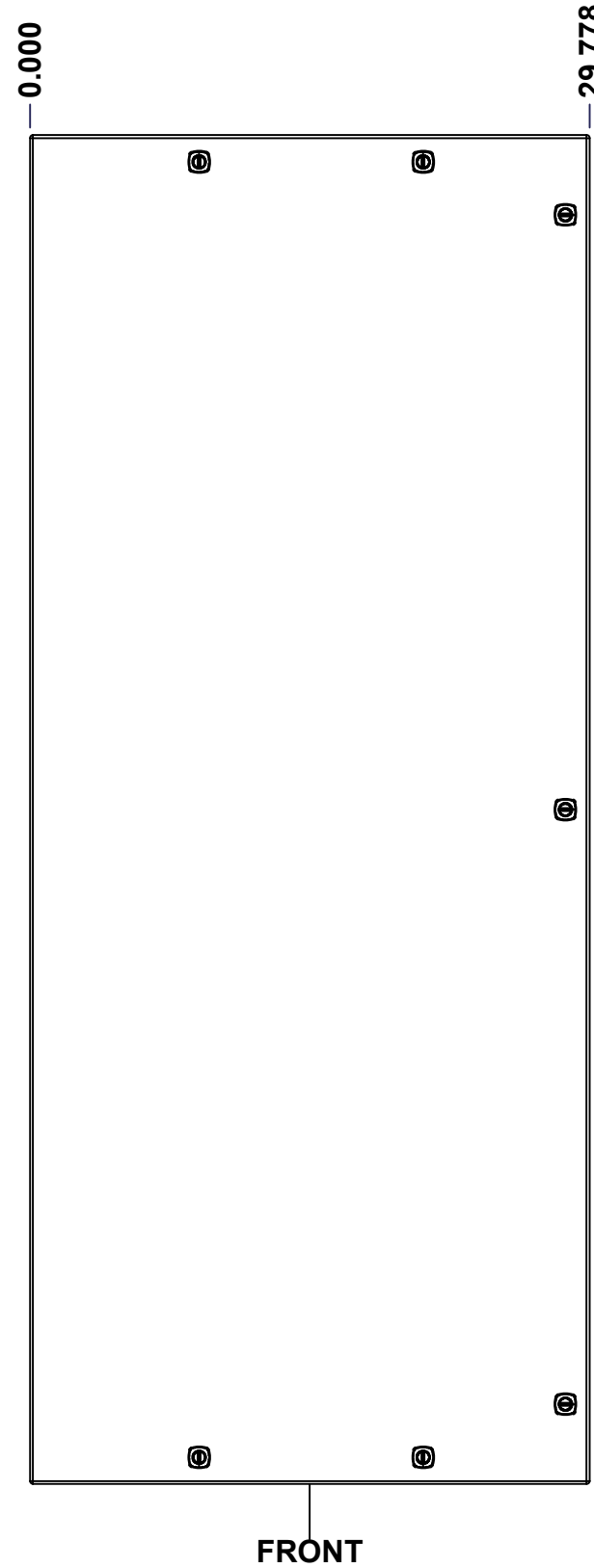
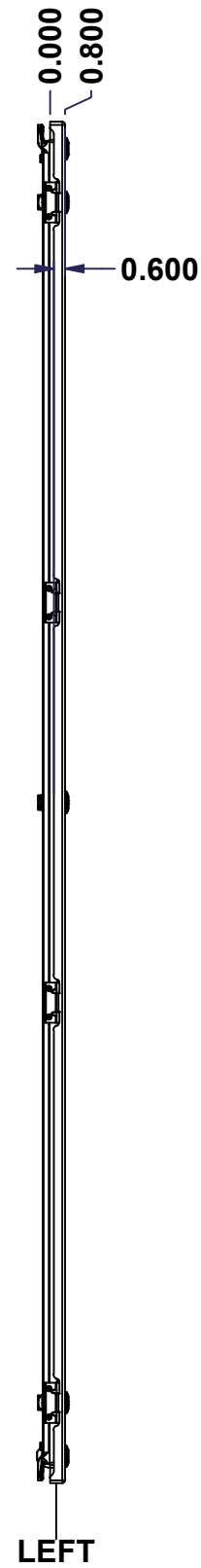
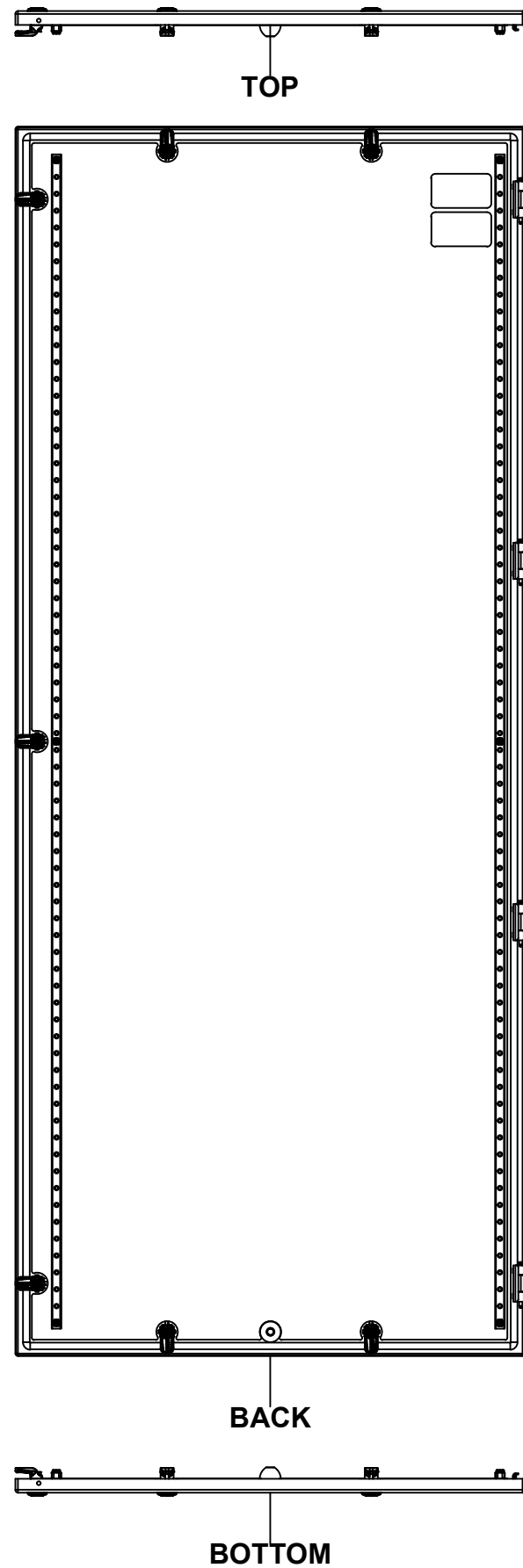

No.	Revisions	Date	By/Par

Isometric View

<p>Tél: (450) 979-4373 Fax: (450) 979-4626 www.exmweb.com</p>		Flatness Aplatissement
		Max 3.0mm
Projection		
Customer Client	Date	
Drawn By Dessiné Par	BoxCad: BoxCad	Date 12-Mar-25
Material Matière	14 Ga Cold Rolled A1008 CS Type B (1.7mm)	
Color Couleur	Asa-61 Grey	Finish Fini Smooth
Description		Detail Rev.
5412ESPR 72" x 30" Cover		
Part Number Numéro Pièce	Rev.	8
5412ESPR723020THC	0	16

SEE BILL OF MATERIAL ON LAST PAGE

This drawing is confidential and must not be reproduced or used without the consent of EXM

Ce dessin est confidentiel et ne doit pas être reproduit ou utilisé sans le consentement de EXM

STANDARD FEATURES ARE NOT LISTED IN THIS HOLE TABLE

HOLE TABLE - FRONT VIEW (CUSTOM FEATURE ONLY)

CUT-OUT	XDIM	YDIM	DESCRIPTION
1	1.486	1.945	STUD M6 x 18mm (Inside)
2	1.486	69.858	STUD M6 x 18mm (Inside)
3	27.377	69.858	STUD M6 x 18mm (Inside)
4	27.377	1.945	STUD M6 x 18mm (Inside)
5	1.486	35.902	STUD M6 x 18mm (Inside)
6	27.377	35.902	STUD M6 x 18mm (Inside)
7	14.959	1.435	STUD M6 x 18mm (Inside)

8	28.494	67.553	LOCK 880 SCQ4-SL @ 0.0°
9	28.494	35.902	LOCK 880 SCQ4-SL @ 0.0°
10	28.494	4.250	LOCK 880 SCQ4-SL @ 0.0°
11	9.000	70.379	LOCK 880 SCQ4-SL @ 90.0°
12	20.918	70.379	LOCK 880 SCQ4-SL @ 90.0°
13	9.000	1.424	LOCK 880 SCQ4-SL @ 270.0°
14	20.918	1.424	LOCK 880 SCQ4-SL @ 270.0°

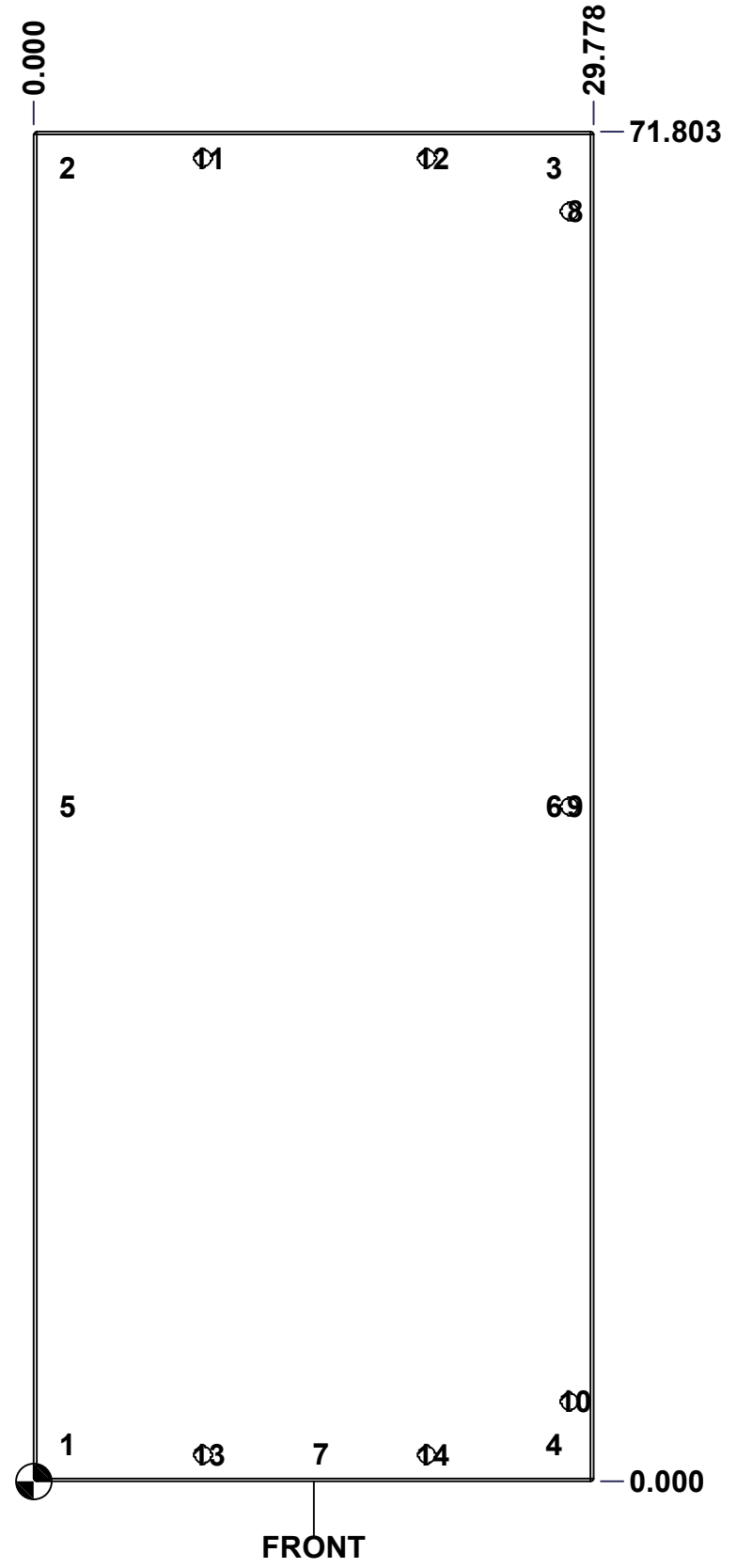

	Description	Status
	5412ESPR 72" x 30" Cover	(NULL)
	Part Number Numéro Pièce	Rev.
	5412ESPR723020THC	0 / 9
		16

This drawing is confidential and must not be reproduced or used without the consent of EXM

Ce dessin est confidentiel et ne doit pas être reproduit ou utilisé sans le consentement de EXM

No.	Revisions	Date	By/Par

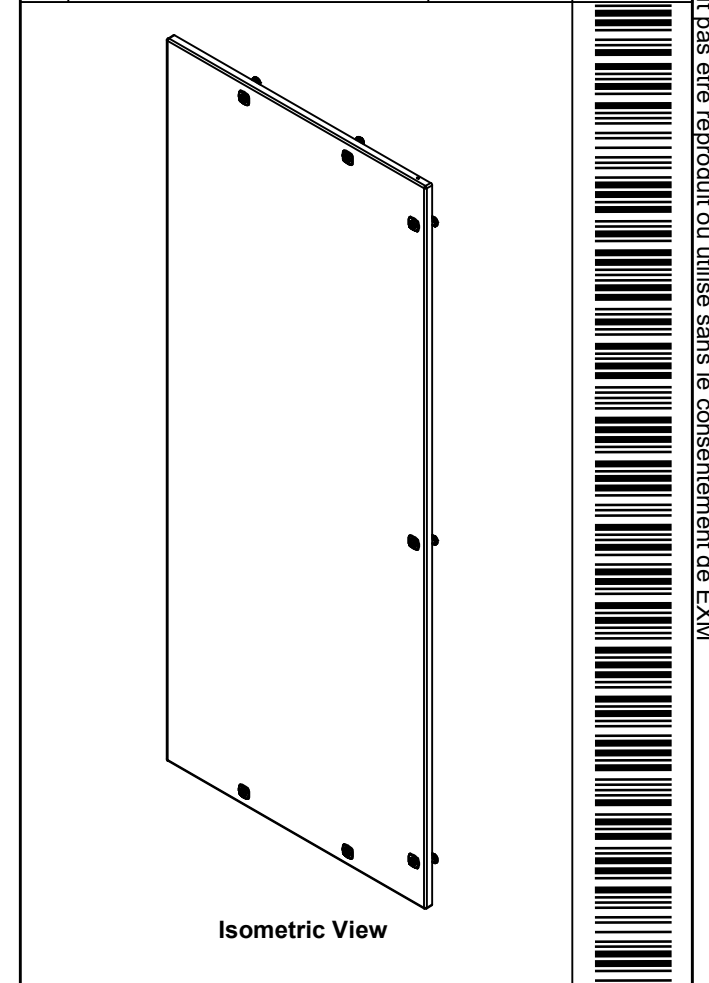

EXM
www.exmweb.com

Tél: (450) 979-4373
Fax: (450) 979-4626

Flatness
Aplatissement
Max 3.0mm

Projection

7	STK-K-12500	19	5412 ES 1/4 Turn Lock
2	STK-S-00100	0	3.5" x 2" Silver Milar Flexcon Sticker
6	STK-Q-07250	2	M6 x 16mm Collar Nut
2	STK-Q-46020-72	5	5412 ES Vertical Door Stiffener 72"
1	5412ESPR723020THI-C	0	5412ESPR 72" x 30" Cover Insulation
1	STK-Q-46515	3	5412 ES Door Support with Brass Insert
7	STK-Q-16055	1	M6 x 18mm Stud (No Paint Cap Required)
1	5412ESPR723020THG	0	5412ESPR 72" x 30" Cover Gasket Part
1	5412ESPR723020THC-P	0	5412ESPR 72" x 30" Cover Part
4	STK-A-33005PR	1	5412 ESPR Hinge 180° (Body Part)

Customer Client	Date
Drawn By Dessiné Par	Date 12-Mar-25
Material Matière	14 Ga Cold Rolled A1008 CS Type B (1.7mm)
Color Couleur	Asa-61 Grey
Finish Fini	Smooth
Description	Detail Rev.
5412ESPR 72" x 30" Cover	
Part Number Numéro Pièce	Rev. 10
5412ESPR723020THC	0 16

QTY	Part Number	Rev	Description
Parts List			

This drawing is confidential and must not be reproduced or used without the consent of EXM

Ce dessin est confidentiel et ne doit pas être reproduit ou utilisé sans le consentement de EXM

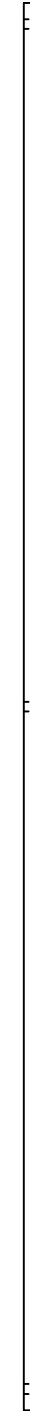
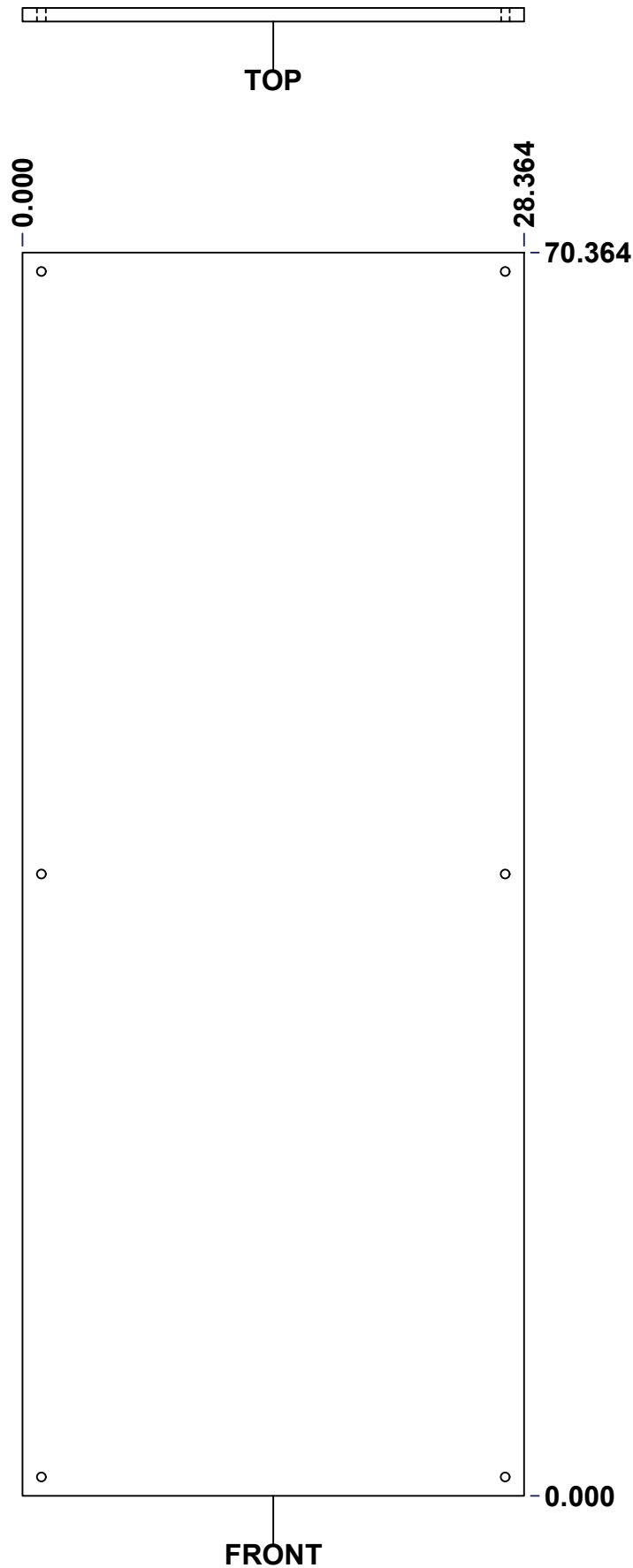

No.	Revisions	Date	By/Par

Isometric View

Tél: (450) 979-4373 Fax: (450) 979-4626 www.exmweb.com		Flatness Aplatissement	
		Max 3.0mm	
Projection		Date	
Customer Client	BoxCad: Patrick Deschenes	Date	23-Jan-07
Drawn By Dessiné Par	Material Matière		Polyisocyanurate
Color Couleur	Aluminum	Finish Fini	N/A
Description		Detail Rev.	
5412ESPR 72" x 30" Back Insulation			
Part Number Numéro Pièce	Rev.	11	16
5412ESPR723020THI-B		0	

SEE BILL OF MATERIAL ON LAST PAGE

This drawing is confidential and must not be reproduced or used without the consent of EXM

Ce dessin est confidentiel et ne doit pas être reproduit ou utilisé sans le consentement de EXM

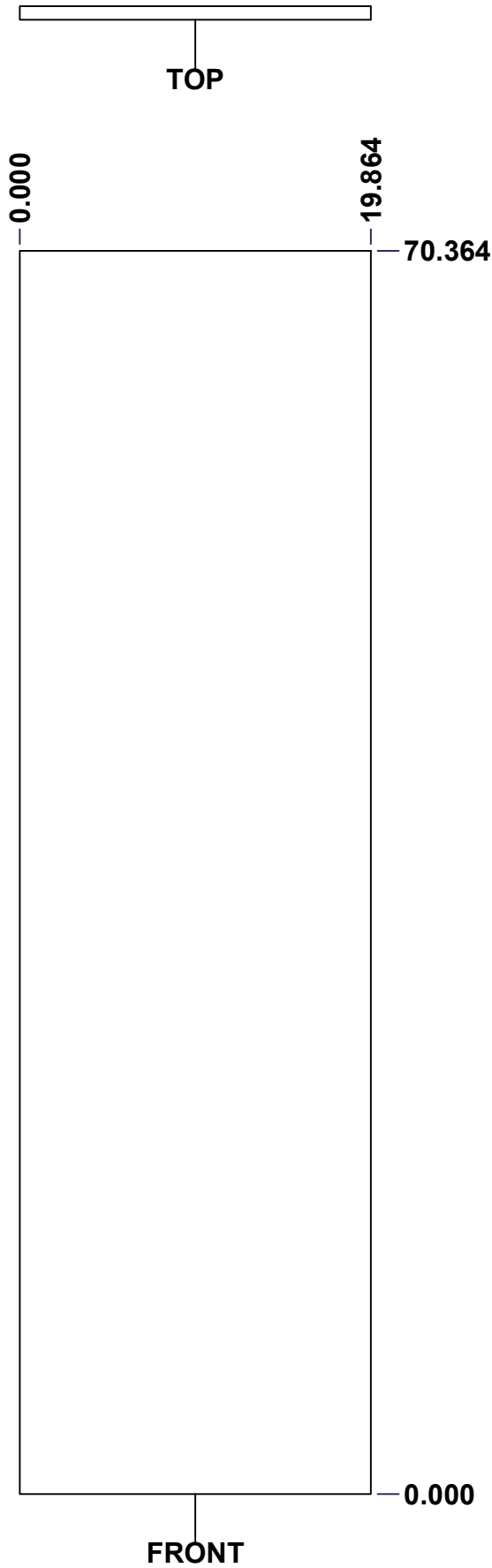

No.	Revisions	Date	By/Par

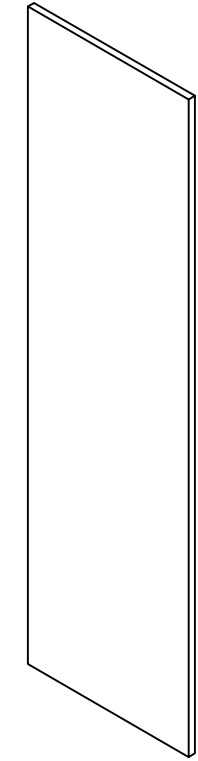

Isometric View

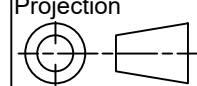

 Tél: (450) 979-4373 Fax: (450) 979-4626 www.exmweb.com		Flatness Aplatissement Max 3.0mm
Projection 		Date 23-Jan-07
Customer Client	Date	
Drawn By Dessiné Par	BoxCad: Patrick Deschenes	Date 23-Jan-07
Material Matière	Polyisocyanurate	
Color Couleur	Aluminum	Finish Fini N/A
Description	Detail Rev.	
5412ESPR 72" x 30" Left Insulation		
Part Number Numéro Pièce	Rev. 0	12 / 16
5412ESPR723020TH-LS		

SEE BILL OF MATERIAL ON LAST PAGE

This drawing is confidential and must not be reproduced or used without the consent of EXM

Ce dessin est confidentiel et ne doit pas être reproduit ou utilisé sans le consentement de EXM

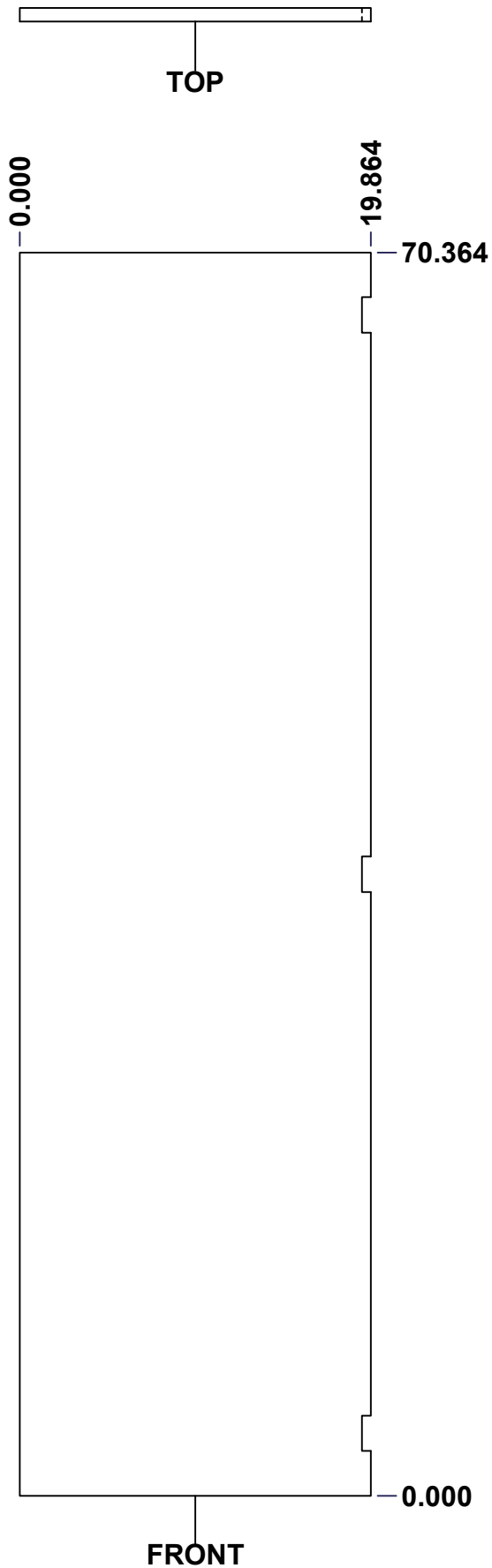

No.	Revisions	Date	By/Par

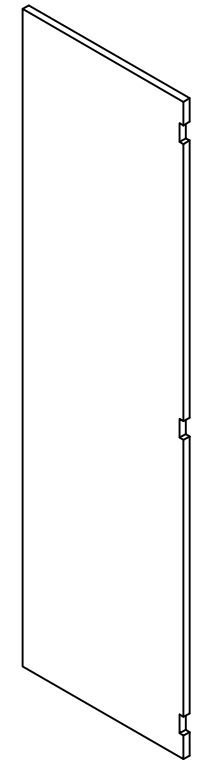

Isometric View

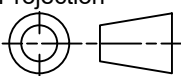

 Tél: (450) 979-4373 Fax: (450) 979-4626 www.exmweb.com	Flatness Aplatissement	Max 3.0mm
	Projection	
Customer Client	Date	
Drawn By Dessiné Par	BoxCad: Patrick Deschenes	Date 23-Jan-07
Material Matière	Polyisocyanurate	
Color Couleur	Aluminum	Finish Fini N/A
Description	Detail Rev.	
5412ESPR 72" x 30" Right Insulation		
Part Number Numéro Pièce	Rev.	13
5412ESPR723020THI-RS	0	16

SEE BILL OF MATERIAL ON LAST PAGE

This drawing is confidential and must not be reproduced or used without the consent of EXM

Ce dessin est confidentiel et ne doit pas être reproduit ou utilisé sans le consentement de EXM

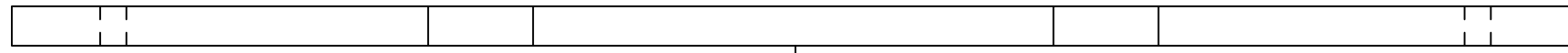

TOP

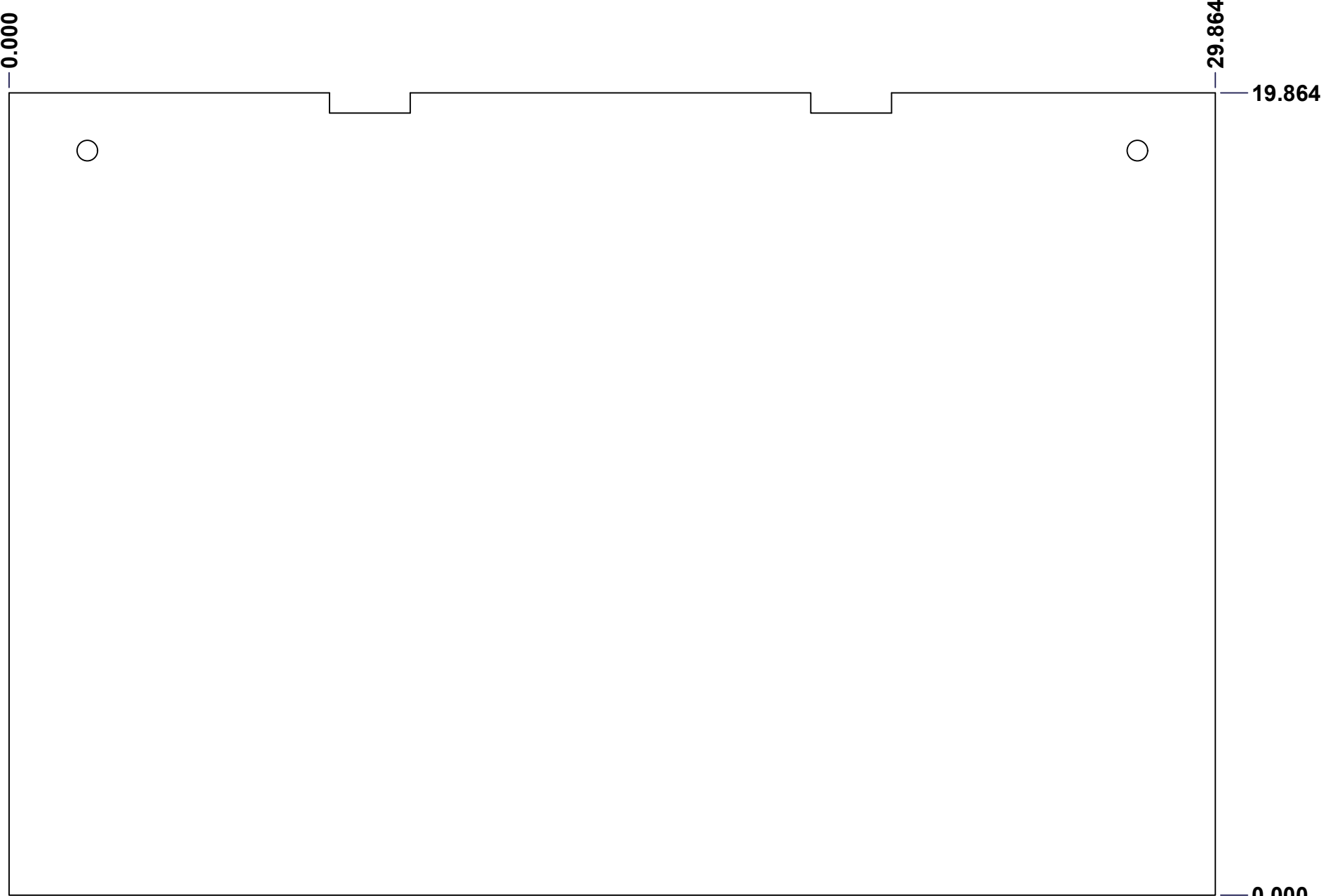

FRONT

RIGHT

No.	Revisions	Date	By/Par

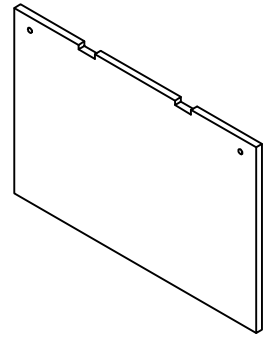

Isometric View



Tél: (450) 979-4373
 Fax: (450) 979-4626
www.exmweb.com

Flatness
Aplatissement
Max 3.0mm
Projection

Customer Client	Date
Drawn By / Dessiné Par: BoxCad: BoxCad	Date: 4/3/2024

Material / Matière: Polyisocyanurate

Color / Couleur: Aluminum	Finish / Fini: Smooth
---------------------------	-----------------------

Description: 5412ESPR 72" x 30"Top Insulation	Detail Rev.
---	-------------

Part Number / Numéro Pièce: 5412ESPR723020THI-TP	Rev. 0	14 / 16
--	--------	---------

SEE BILL OF MATERIAL ON LAST PAGE

This drawing is confidential and must not be reproduced or used without the consent of EXM

Ce dessin est confidentiel et ne doit pas être reproduit ou utilisé sans le consentement de EXM

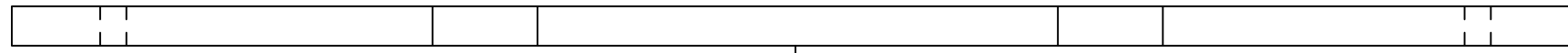

TOP

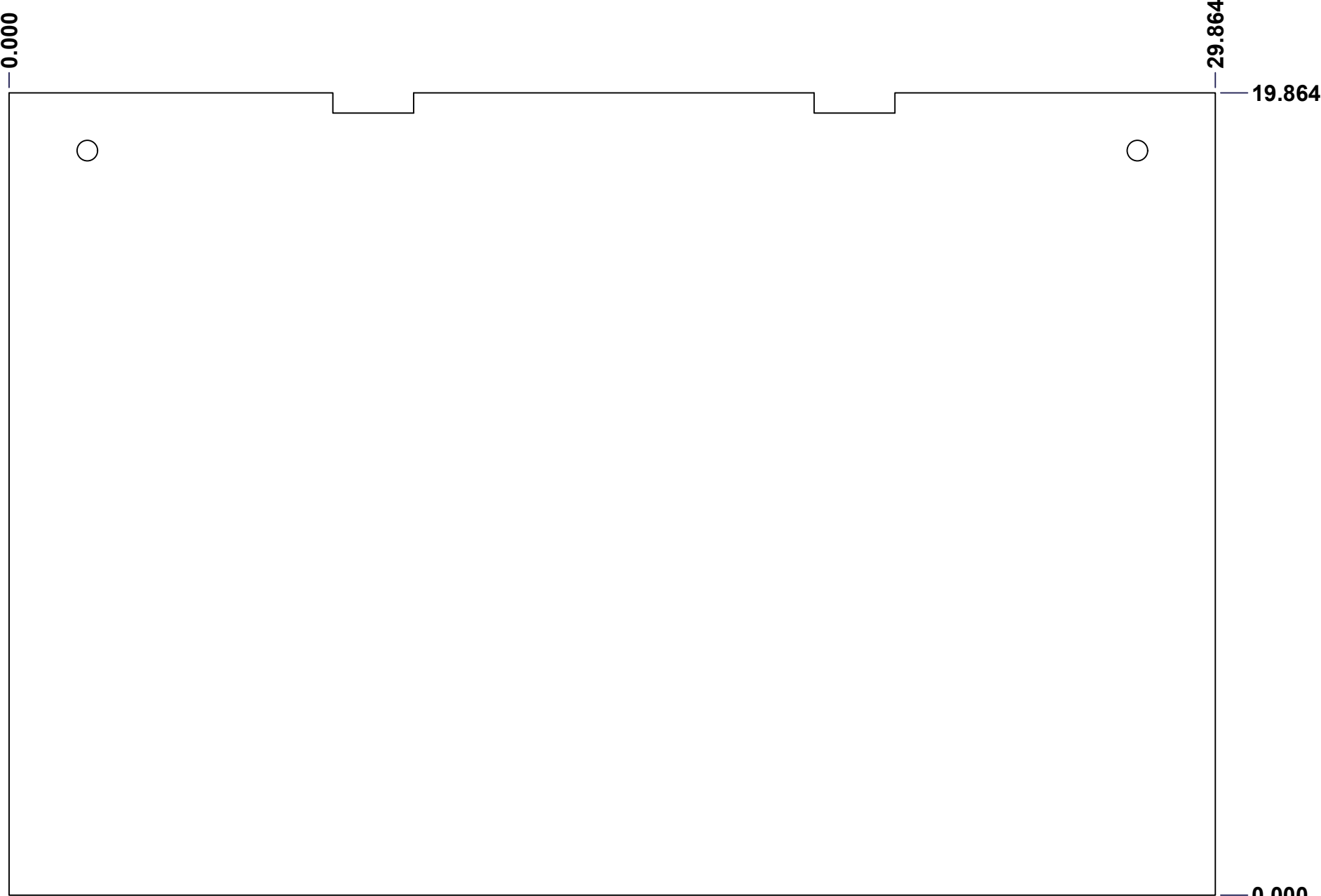

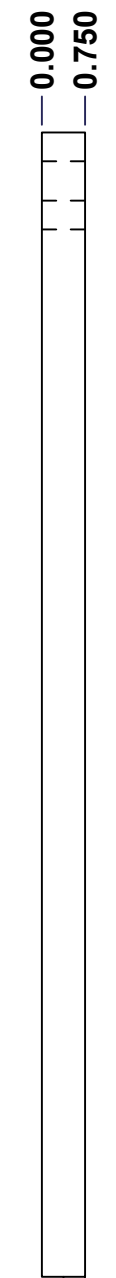

FRONT

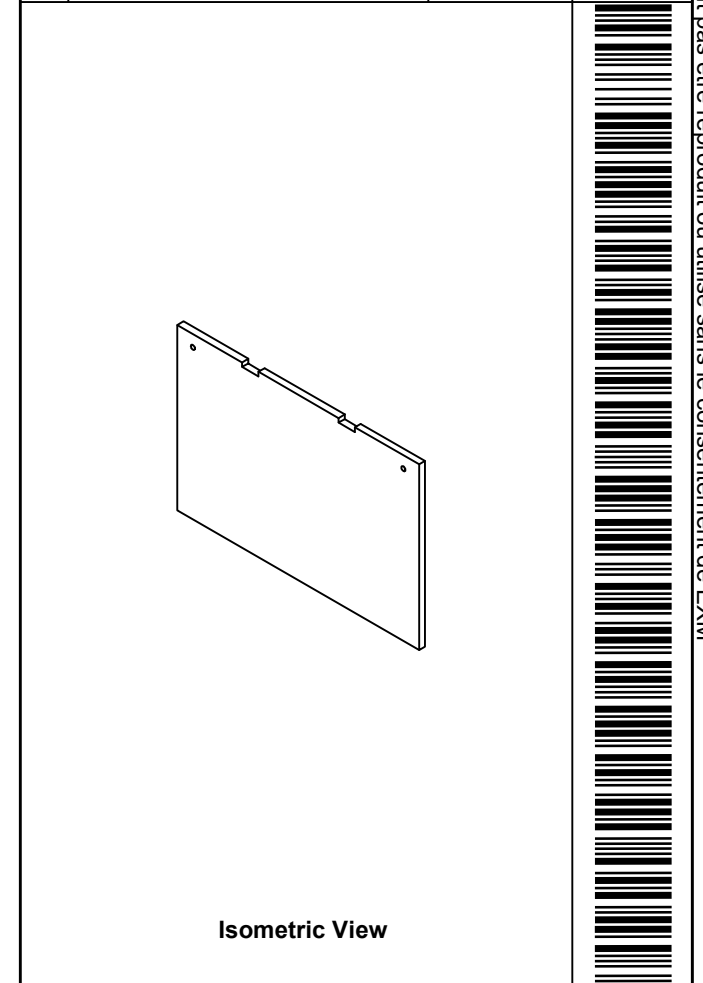

RIGHT

No.	Revisions	Date	By/Par

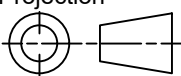

 Tél: (450) 979-4373 Fax: (450) 979-4626 www.exmweb.com		Flatness Aplatissement	Max 3.0mm
		Projection	
Customer Client	Date	Date 4/3/2024	
Drawn By Dessiné Par	BoxCad: BoxCad	Date 4/3/2024	
Material Matière	Polyisocyanurate		
Color Couleur	Aluminum	Finish Fini	Smooth
Description		Detail Rev.	
5412ESPR 72" x 30"Bottom Insulation			
Part Number Numéro Pièce	Rev.	15	16
SEE BILL OF MATERIAL ON LAST PAGE		0	
5412ESPR723020THI-BT			

This drawing is confidential and must not be reproduced or used without the consent of EXM

Ce dessin est confidentiel et ne doit pas être reproduit ou utilisé sans le consentement de EXM

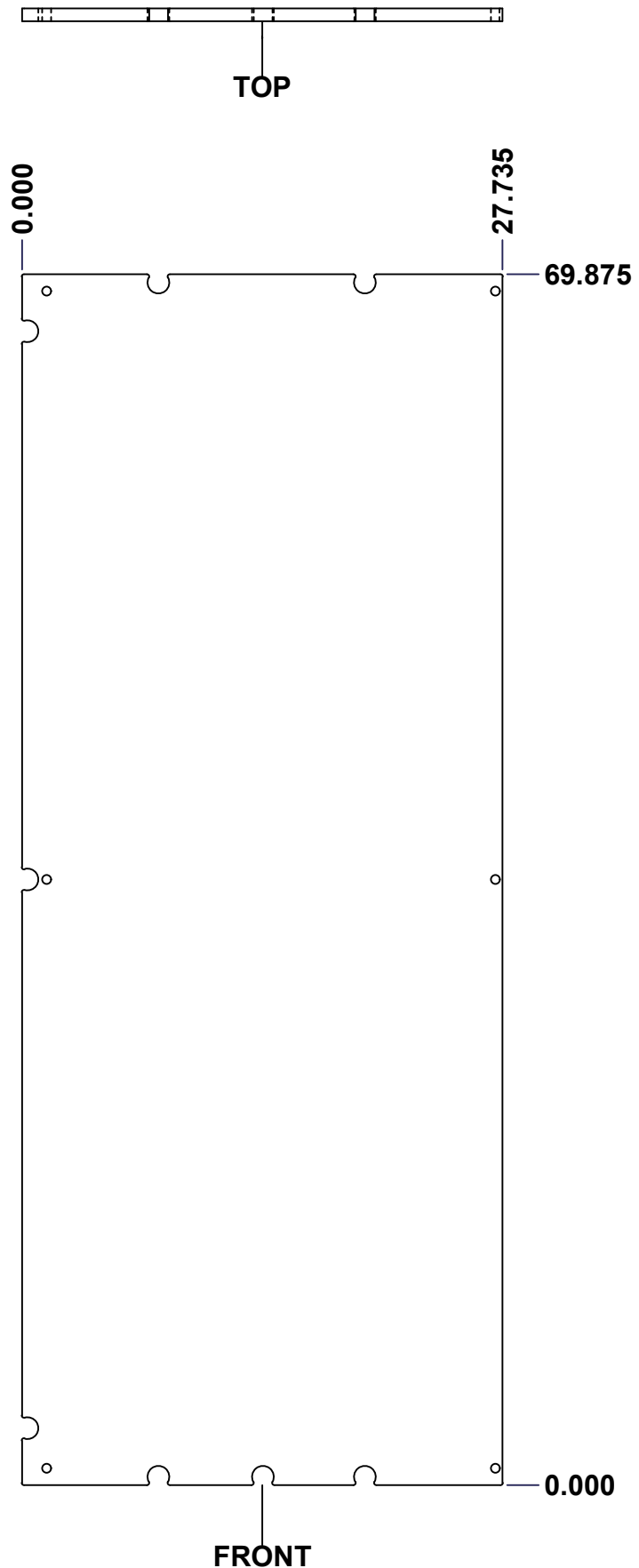

No.	Revisions	Date	By/Par

Isometric View

Tél: (450) 979-4373 Fax: (450) 979-4626 www.exmweb.com		Flatness Aplatissement	
		Max 3.0mm	
Customer Client		Date	
Drawn By Dessiné Par		Date	
Material Matière		Polyisocyanurate	
Color Couleur		Aluminum	Finish Fini
Description		Detail Rev.	
5412ESPR 72" x 30" Cover Insulation			
Part Number Numéro Pièce		Rev.	
5412ESPR723020THI-C		0	16

SEE BILL OF MATERIAL ON LAST PAGE

This drawing is confidential and must not be reproduced or used without the consent of EXM

Ce dessin est confidentiel et ne doit pas être reproduit ou utilisé sans le consentement de EXM

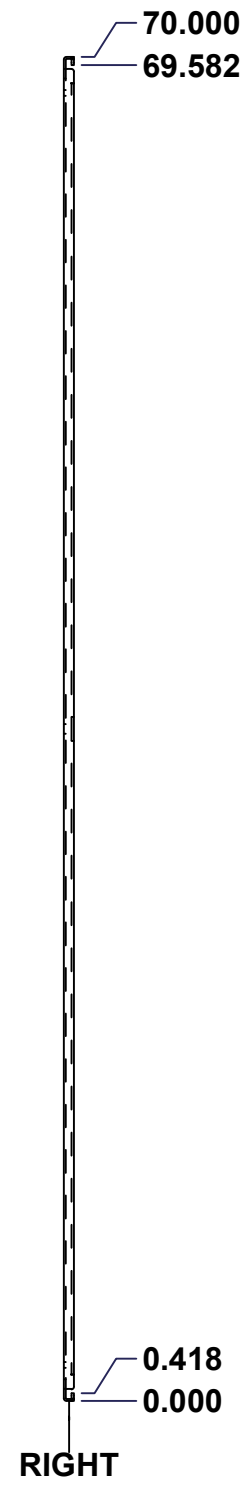
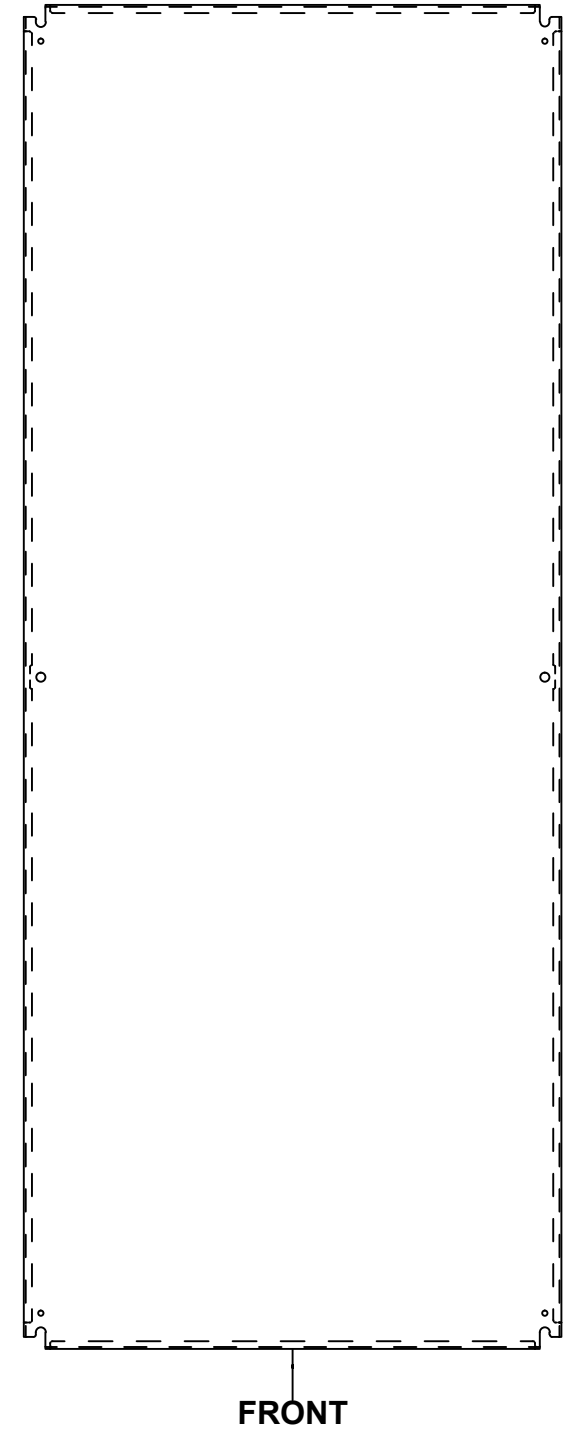
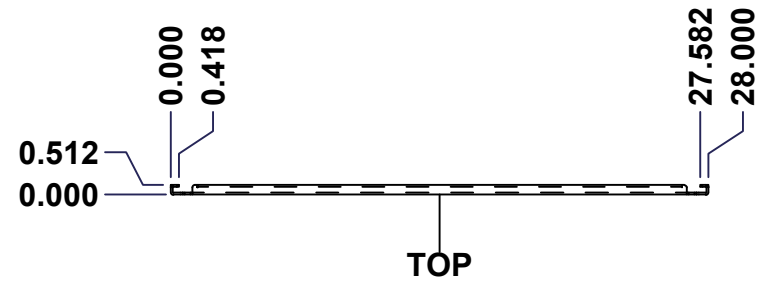

No.	Revisions	Date	By/Par

Isometric View

<p>Tél: (450) 979-4373 Fax: (450) 979-4626 www.exmweb.com</p>	Flatness Aplatissement Max 3.0mm
	Projection
Customer Client	Date
Drawn By / Dessiné Par: BoxCad	Date: 23-Jan-07
Material / Matière: See Part List	
Color / Couleur: See Part List	Finish / Fini: See Part List
Description: 881 SP - Inner Panel	Detail Rev.
Part Number / Numéro Pièce: 881 SP7230G	Rev. 1/2

Qty	Part Number	Rev	Description	Material	Color	Finish
1	881 SP7230G-P	0	881 SP - Inner Panel Part	12 Ga Galvanized	Unpainted	Galvanized

Parts List

This drawing is confidential and must not be reproduced or used without the consent of EXM

Ce dessin est confidentiel et ne doit pas être reproduit ou utilisé sans le consentement de EXM

Table 1			FRONT VIEW
CUT-OUT	XDIM	YDIM	DESCRIPTION
1	0.875	1.875	GROUND HOLE (RND Ø0.290)
2	27.125	1.875	GROUND HOLE (RND Ø0.290)
3	0.875	68.125	GROUND HOLE (RND Ø0.290)
4	27.125	68.125	GROUND HOLE (RND Ø0.290)
5	0.875	35.000	MTG STUD HOLE (RND Ø0.500)
6	27.125	35.000	MTG STUD HOLE (RND Ø0.500)

All knockouts are actual size / Les disques défonçables sont grandeur réel

No.	Revisions	Date	By/Par

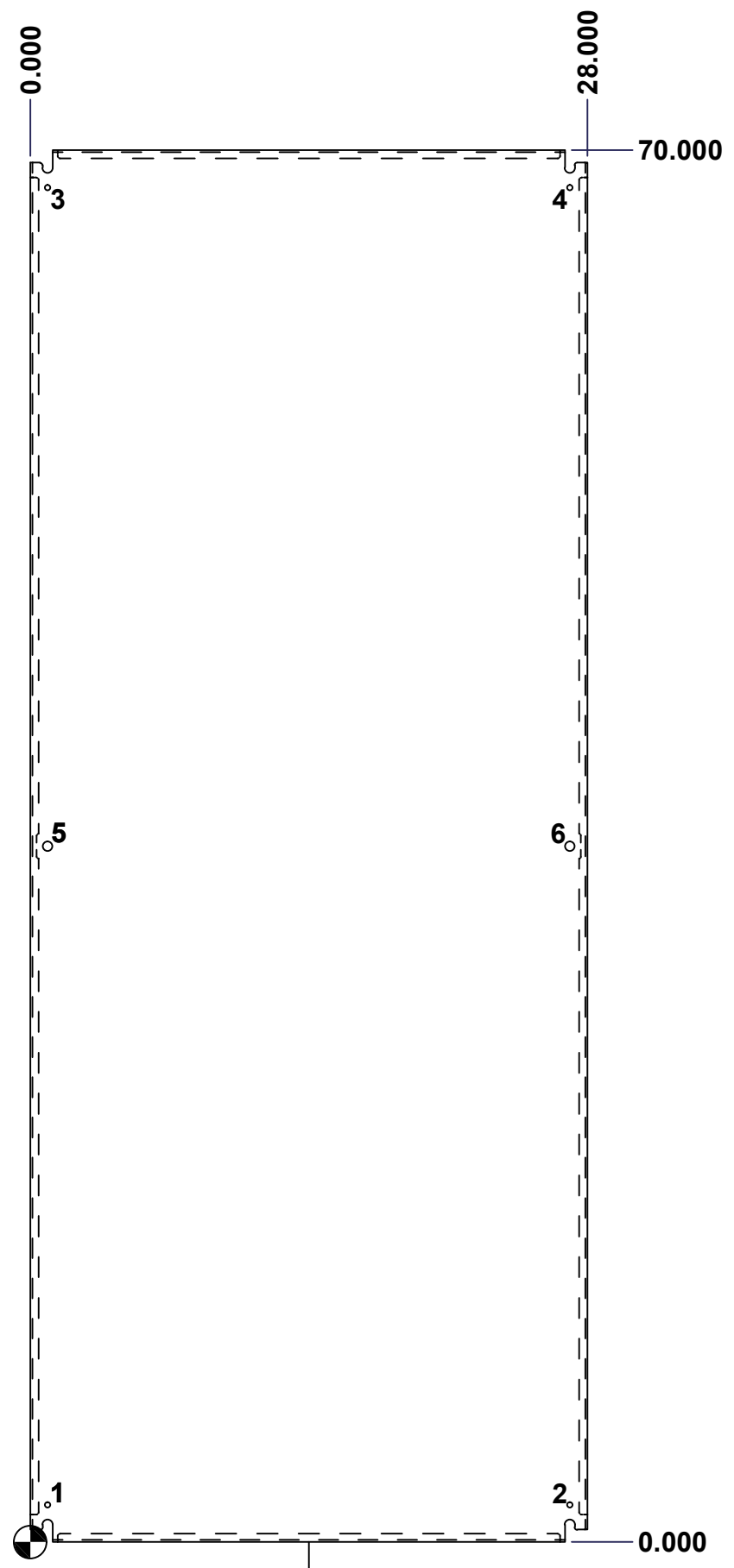

FRONT

Isometric View

		Tél: (450) 979-4373 Fax: (450) 979-4626 www.exmweb.com		Flatness Aplatissement Max 3.0mm	
Customer Client		Date		Projection 	
Drawn By Dessiné Par BoxCad		Date 23-Jan-07		Material Matière See Part List	
Color Couleur See Part List		Finish Fini See Part List		Description 881 SP - Inner Panel	
Part Number Numéro Pièce 881 SP7230G		Rev. 0		Detail Rev. 2	