

This drawing is confidential and must not be reproduced or used without the consent of EXM

Ce dessin est confidentiel et ne doit pas être reproduit ou utilisé sans le consentement de EXM

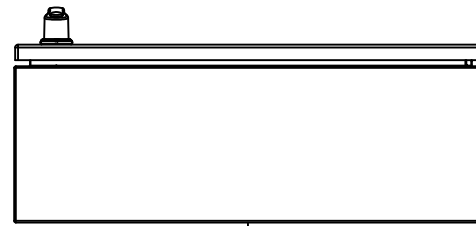

TOP

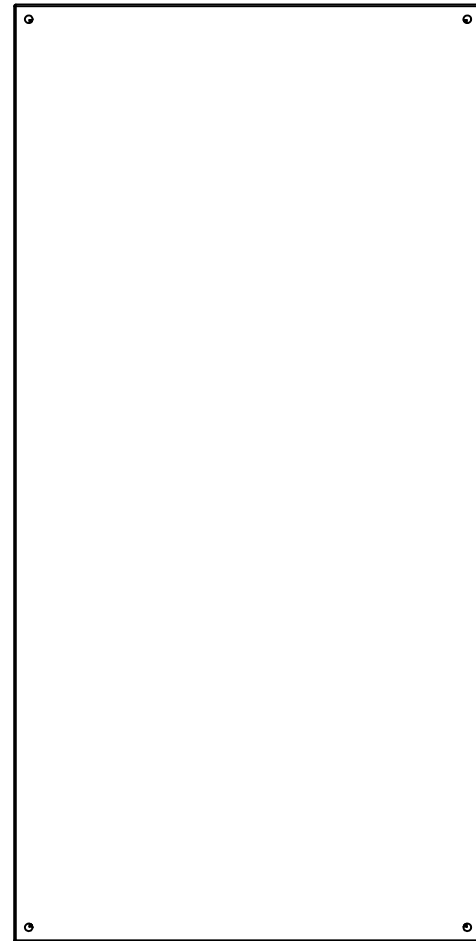

BACK

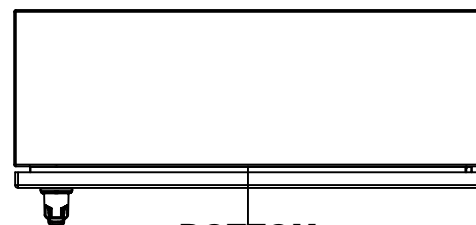

BOTTOM

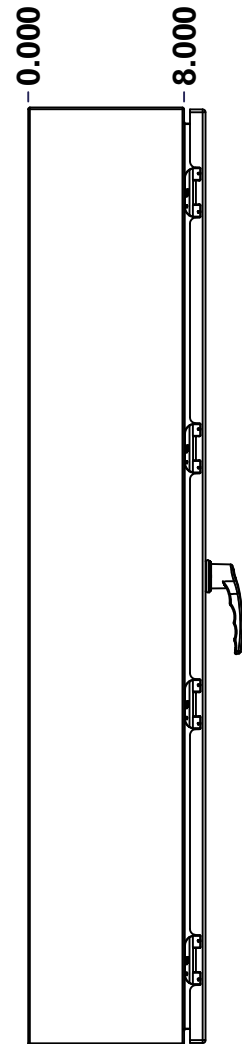

LEFT

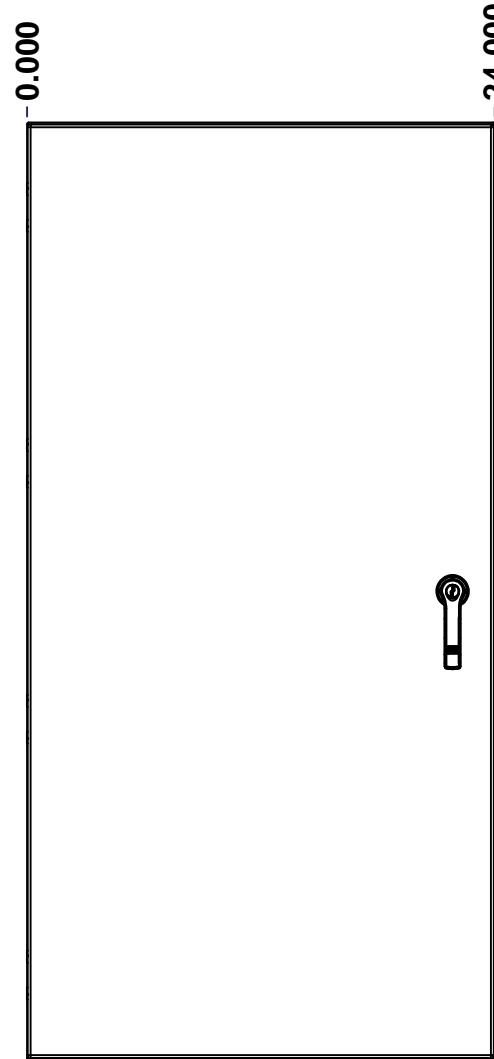

FRONT

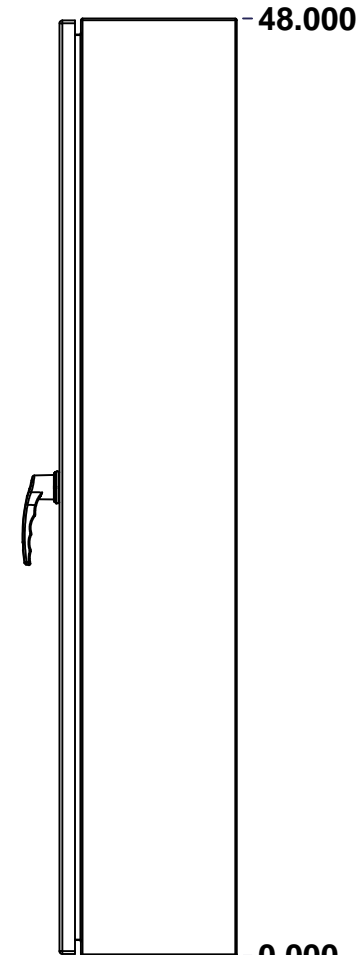

RIGHT

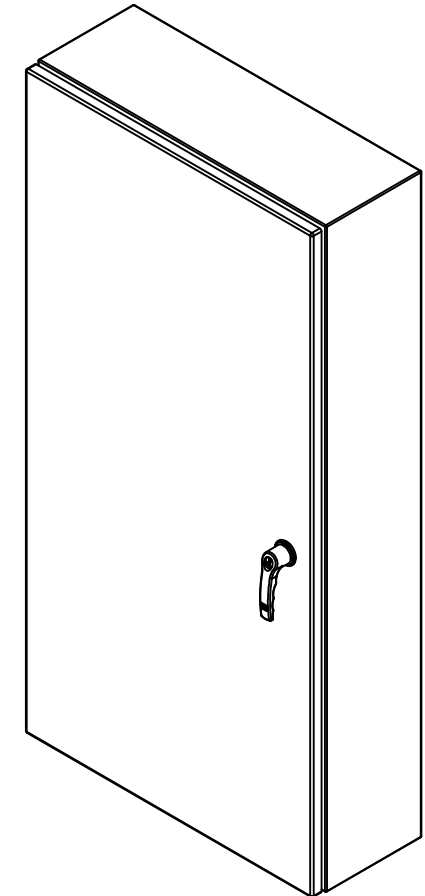

Isometric View



**GRAIN DIRECTION:
TOP/BOTTOM: HORIZONTAL
LEFT/RIGHT/BACK/FRONT: VERTICAL**

SEE BILL OF MATERIAL ON LAST PAGE

| No. | Revisions | Date | By/Par |
|-----|-----------|------|--------|
| | | | |
| | | | |
| | | | |
| | | | |
| | | | |

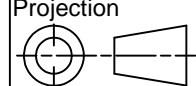
| | | |
|--|-----------------------------------|---|
|  Tél: (450) 979-4373 Fax: (450) 979-4626 www.exmweb.com | | Flatness Aplatissement Max 3.0mm Projection  |
| Customer Client | Date | Date |
| Drawn By Dessiné Par | BoxCad: BoxCad | 08-Feb-14 |
| Material Matière | 16 Ga Stainless Steel 304 (1.4mm) | |
| Color Couleur | Unpainted | Finish Fini: Brushed |
| Description | 5412ESS 48" x 24" x 8" Assembly | |
| Part Number Numéro Pièce | Rev. 0 | 1 2 |

This drawing is confidential and must not be reproduced or used without the consent of EXM

Ce dessin est confidentiel et ne doit pas être reproduit ou utilisé sans le consentement de EXM

| NOTE | |
|------|--|
| ITEM | DESCRIPTION |
| 1 | NEMA 4X Enclosure |
| 2 | C/W Standard ground studs on box and cover |
| 3 | C/W Standard door stiffener |
| 4 | C/W Standard inner panel (Included) |
| 5 | C/W Standard inner panel mounting studs |

| No. | Revisions | Date | By/Par |
|-----|-----------|------|--------|
| | | | |
| | | | |
| | | | |
| | | | |
| | | | |
| | | | |

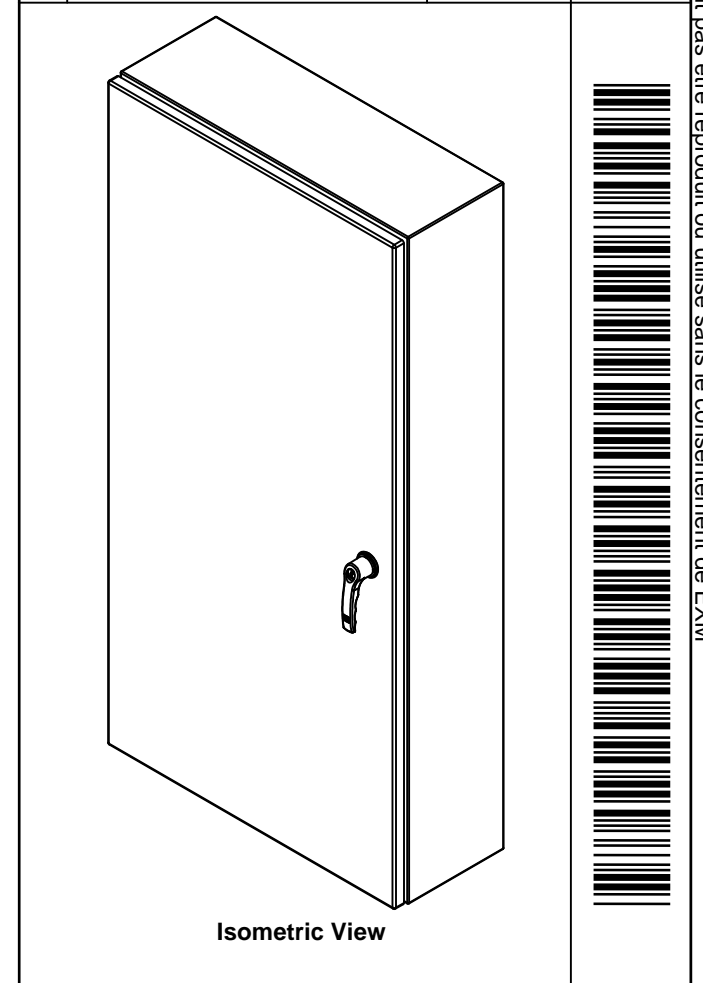

EXM
www.exm.com

Tél: (450) 979-4373
Fax: (450) 979-4626
www.exmweb.com

Flatness
Aplatissement
Max 3.0mm
Projection

| PACKING | | |
|-----------------------|-----|--|
| ITEM | QTY | DESCRIPTION |
| Cardboard sleeve | 2 | Top and Bottom |
| Cardboard strip | 2 | Between back of enclosure and inner panel |
| Plastic bag | 1 | To protect cover surface and inside gasket |
| Cardboard corner | 4 | To reinforced for the plastic strap tightening |
| Plastic strap - Black | 2 | To Squeeze the 2 cardboard sleeve together |
| Packaging label | 3 | White label with PN |
| Plastic strap- Green | 2 | To secure the enclosure to the wood pallet |
| Wood Pallet | 1 | 2" deeper and 3" larger than enclosure size |

| | | | |
|------------|----------------|-----|--|
| 1 | 880 PP | 6 | Self Adhesive Print Pocket |
| 1 | STK-K-01800 | 5 | 5412 ES Accessory Kit |
| 1 | 881 SP4824G | 0 | 881 SP - Inner Panel |
| 1 | 5412ESS482408C | 0 | 5412ESS 48" x 24" Cover |
| 6 | STK-Q-07310 | 2 | Flange Lock Nut M8 |
| 6 | STK-Q-07610 | 8 | M8 Plastic Spacer 22.2mm |
| 1 | 5412ESS482408B | 0 | 5412ESS 48" x 24" x 8" Body |
| 4 | STK-Q-04051-07 | 8 | M6 x 7mm Stainless Steel Hexagon Socket Head Machine Screw with Nyseal |
| Qty | Part Number | Rev | Description |
| Parts List | | | |

Customer Client _____ Date _____

Drawn By _____ Date 08-Feb-14
Dessiné Par BoxCad: BoxCad

Material Matière 16 Ga Stainless Steel 304 (1.4mm)

Color Couleur Unpainted Finish Fini Brushed

Description 5412ESS 48" x 24" x 8" Assembly Detail Rev. _____

Part Number Numéro Pièce **5412ESS482408** Rev. **0**

This drawing is confidential and must not be reproduced or used without the consent of EXM

Ce dessin est confidentiel et ne doit pas être reproduit ou utilisé sans le consentement de EXM

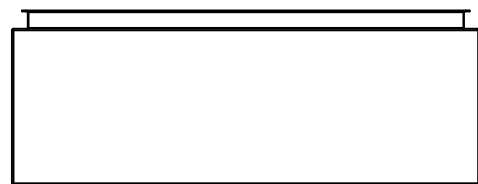

TOP

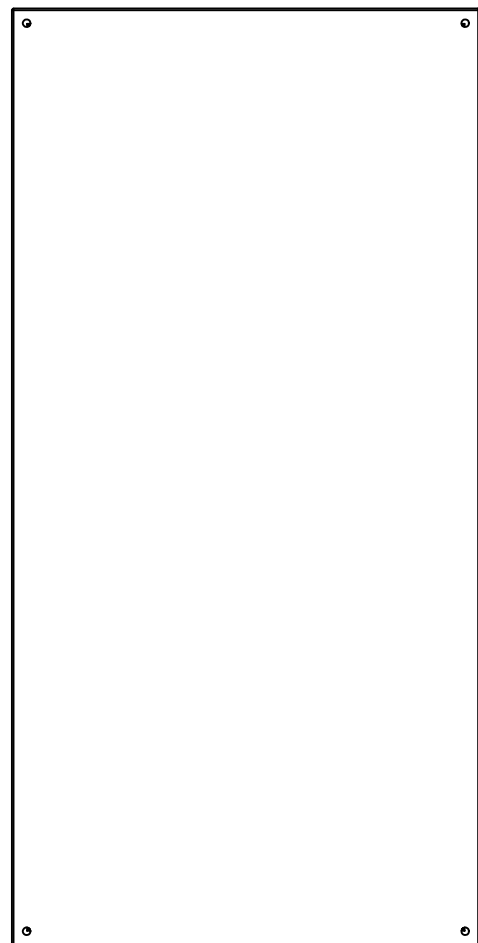

BACK

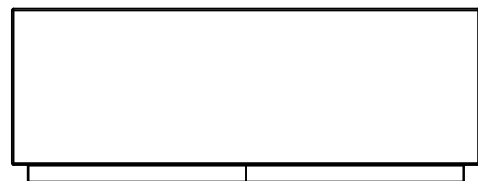

BOTTOM

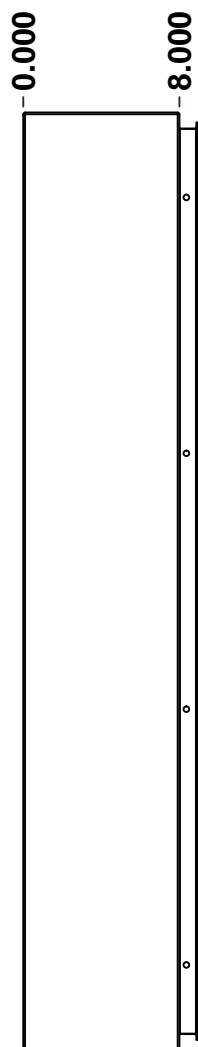

LEFT

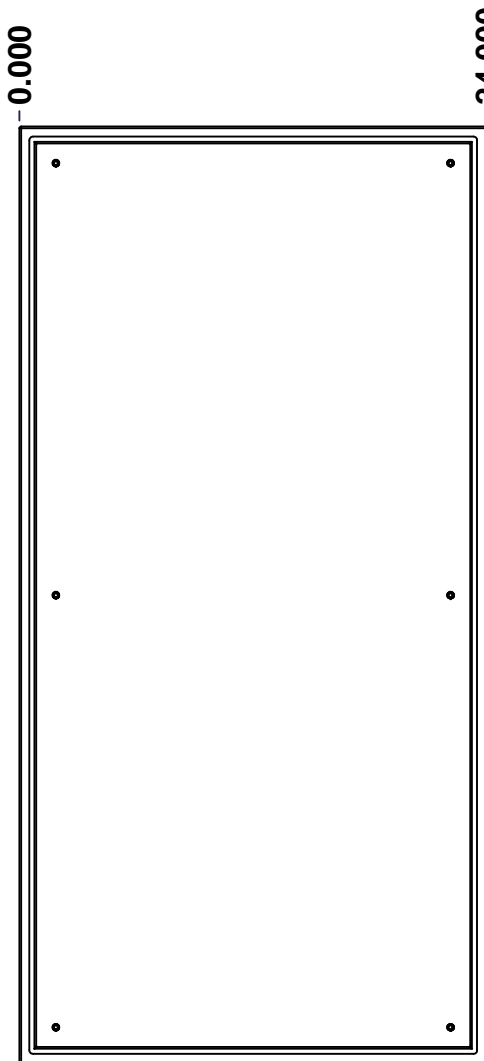

FRONT

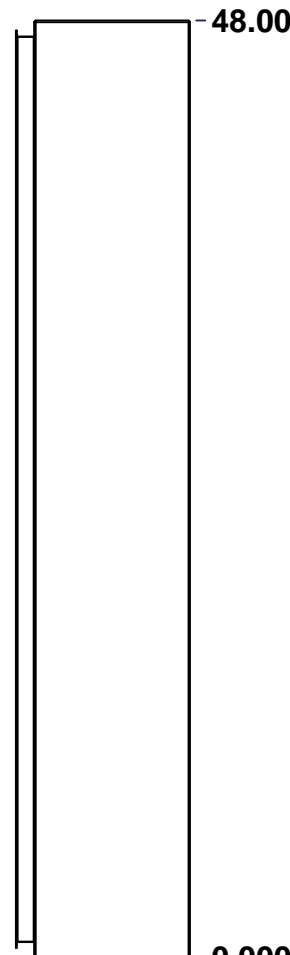

RIGHT

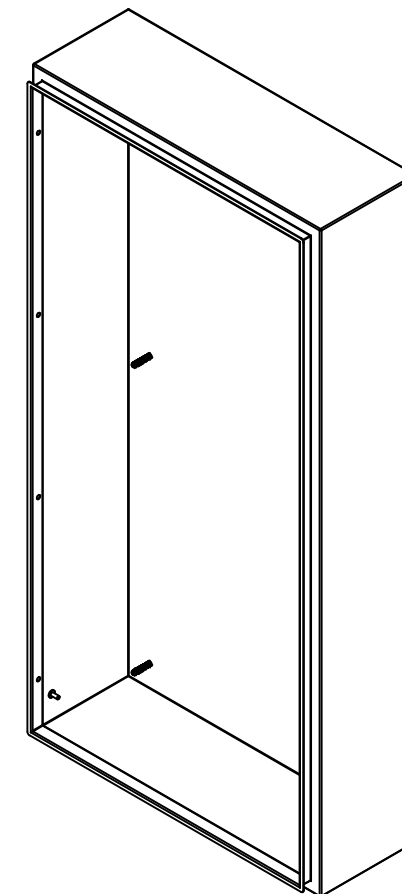

Isometric View



| No. | Revisions | Date | By/Par |
|-----|-----------|------|--------|
| | | | |
| | | | |
| | | | |
| | | | |
| | | | |

| | | |
|--|-----------------------------------|---|
|  Tél: (450) 979-4373 Fax: (450) 979-4626 www.exmweb.com | | Flatness Aplatissement Max 3.0mm Projection  |
| Customer Client | Date | |
| Drawn By Dessiné Par | BoxCad: BoxCad | Date 08-Feb-14 |
| Material Matière | 16 Ga Stainless Steel 304 (1.4mm) | |
| Color Couleur | Unpainted | Finish Fini Brushed |
| Description | Detail Rev. | |
| 5412ESS 48" x 24" x 8" Body | | |
| Part Number Numéro Pièce | Rev. 0 | 1 / 7 |
| 5412ESS482408B | | |

SEE BILL OF MATERIAL ON LAST PAGE

This drawing is confidential and must not be reproduced or used without the consent of EXM

Ce dessin est confidentiel et ne doit pas être reproduit ou utilisé sans le consentement de EXM

STANDARD FEATURES ARE NOT LISTED IN THIS HOLE TABLE

HOLE TABLE - LEFT VIEW (CUSTOM FEATURE ONLY)

| CUT-OUT | XDIM | YDIM | DESCRIPTION |
|---------|-------|-------|-----------------------------|
| 1 | 6.500 | 2.000 | GND STUD M6 x 16mm (Inside) |

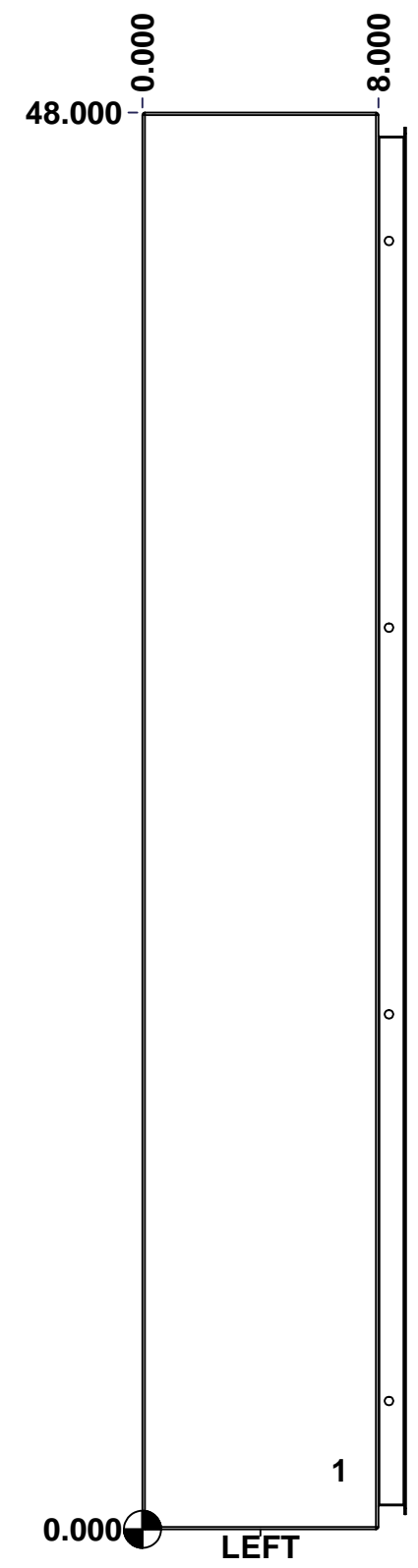

| | | | |
|--|-----------------------------|----------|-------|
| | Description | Status | |
| | 5412ESS 48" x 24" x 8" Body | | |
| | Part Number Numéro Pièce | Rev. | |
| | 5412ESS482408B | 0 | 5 / 7 |

This drawing is confidential and must not be reproduced or used without the consent of EXM

Ce dessin est confidentiel et ne doit pas être reproduit ou utilisé sans le consentement de EXM

STANDARD FEATURES ARE NOT LISTED IN THIS HOLE TABLE

HOLE TABLE - BACK VIEW (CUSTOM FEATURE ONLY)

| CUT-OUT | XDIM | YDIM | DESCRIPTION |
|---------|--------|--------|----------------------------|
| 1 | 1.875 | 1.875 | IP STUD M8 x 35mm (Inside) |
| 2 | 1.875 | 46.125 | IP STUD M8 x 35mm (Inside) |
| 3 | 22.125 | 46.125 | IP STUD M8 x 35mm (Inside) |
| 4 | 22.125 | 1.875 | IP STUD M8 x 35mm (Inside) |
| 5 | 1.875 | 24.000 | IP STUD M8 x 35mm (Inside) |
| 6 | 22.125 | 24.000 | IP STUD M8 x 35mm (Inside) |
| ----- | | | |
| 7 | 23.250 | 0.750 | RND Ø0.390 |
| 8 | 23.250 | 47.250 | RND Ø0.390 |
| 9 | 0.750 | 47.250 | RND Ø0.390 |
| 10 | 0.750 | 0.750 | RND Ø0.390 |

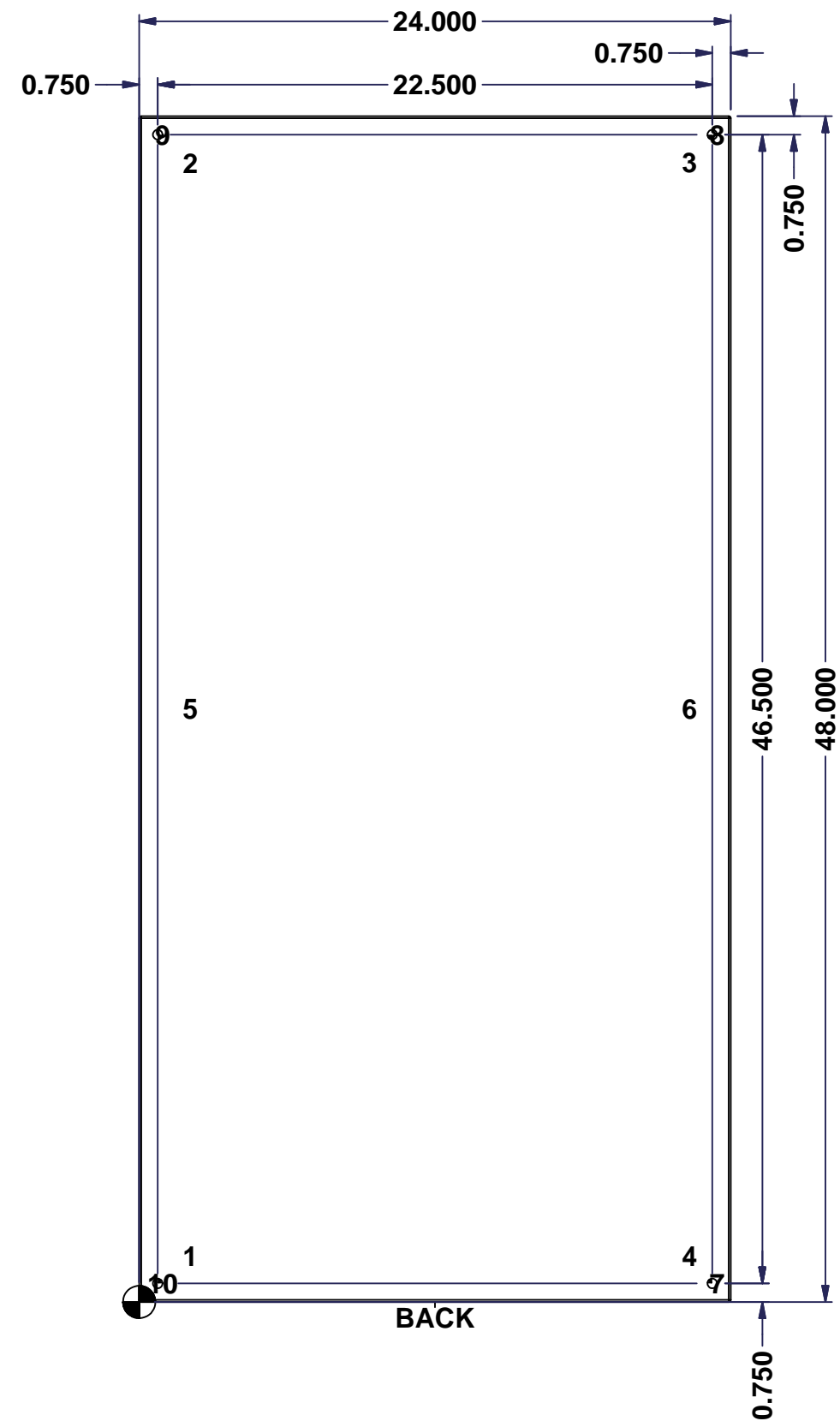



| | | |
|--|-----------------------------|----------|
| | Description | Status |
| | 5412ESS 48" x 24" x 8" Body | |
| | Part Number | Rev. |
| | Numéro Pièce | 6 |
| | 5412ESS482408B | 0 |
| | | 7 |

This drawing is confidential and must not be reproduced or used without the consent of EXM

Ce dessin est confidentiel et ne doit pas être reproduit ou utilisé sans le consentement de EXM

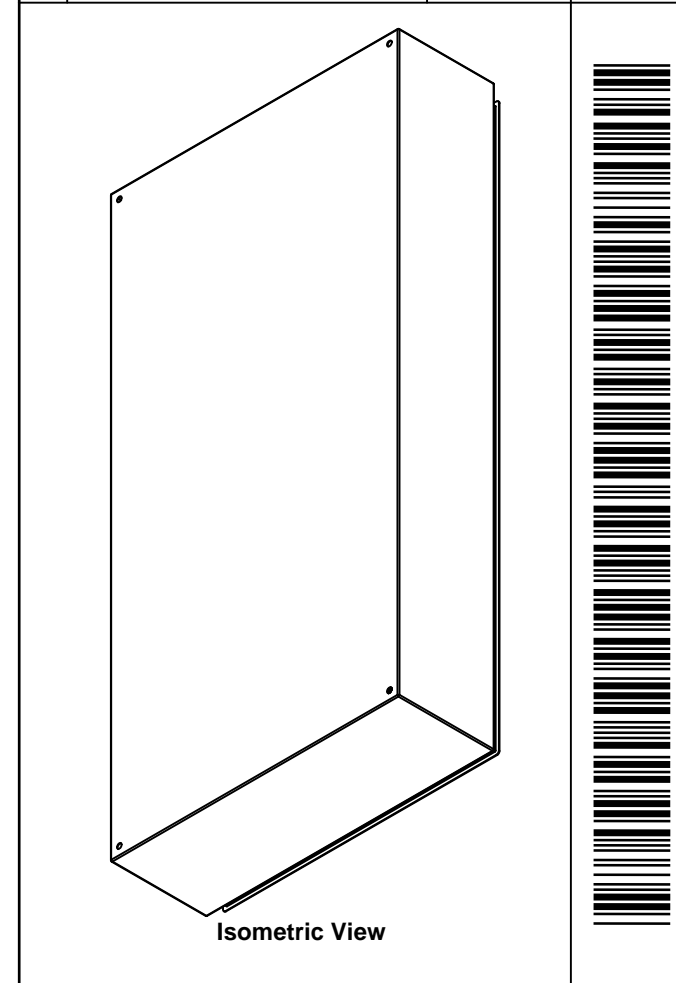
| No. | Revisions | Date | By/Par |
|-----|-----------|------|--------|
| | | | |
| | | | |
| | | | |
| | | | |
| | | | |

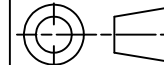

| | | |
|--|-----------------------------------|---|
|  Tél: (450) 979-4373 Fax: (450) 979-4626 www.exmweb.com | | Flatness Aplatissement Max 3.0mm Projection  |
| Customer Client | Date | |
| Drawn By Dessiné Par | BoxCad: BoxCad | Date 08-Feb-14 |
| Material Matière | 16 Ga Stainless Steel 304 (1.4mm) | |
| Color Couleur | Unpainted | Finish Fini Brushed |
| Description | | Detail Rev. |
| 5412ESS 48" x 24" x 8" Body | | |
| Part Number Numéro Pièce | Rev. | 7 |
| 5412ESS482408B | 0 | 7 |

| Qty | Part Number | Rev | Description |
|------------|------------------|-----|---------------------------------------|
| 1 | STK-Q-16085 | 0 | Ground Stud M6 x 16mm Stainless Steel |
| 6 | STK-Q-16020 | 1 | Stud M8 x 35mm Stainless Steel |
| 1 | 5412ESS482408B-P | 0 | 5412ESS 48" x 24" x 8" Body Part |
| Parts List | | | |

This drawing is confidential and must not be reproduced or used without the consent of EXM

Ce dessin est confidentiel et ne doit pas être reproduit ou utilisé sans le consentement de EXM

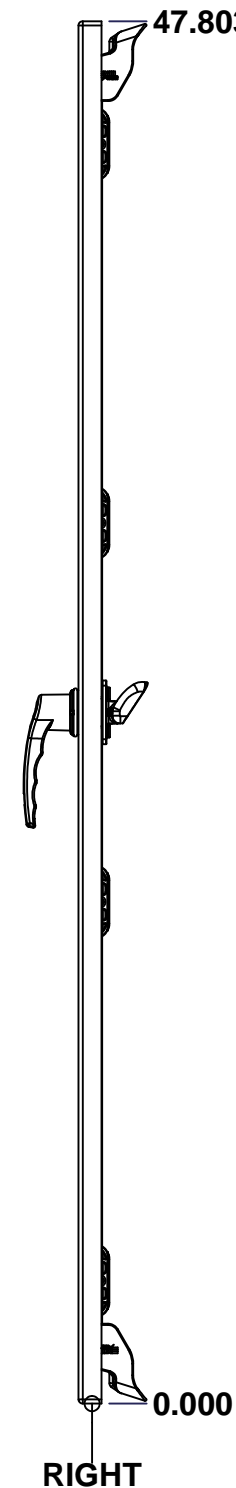
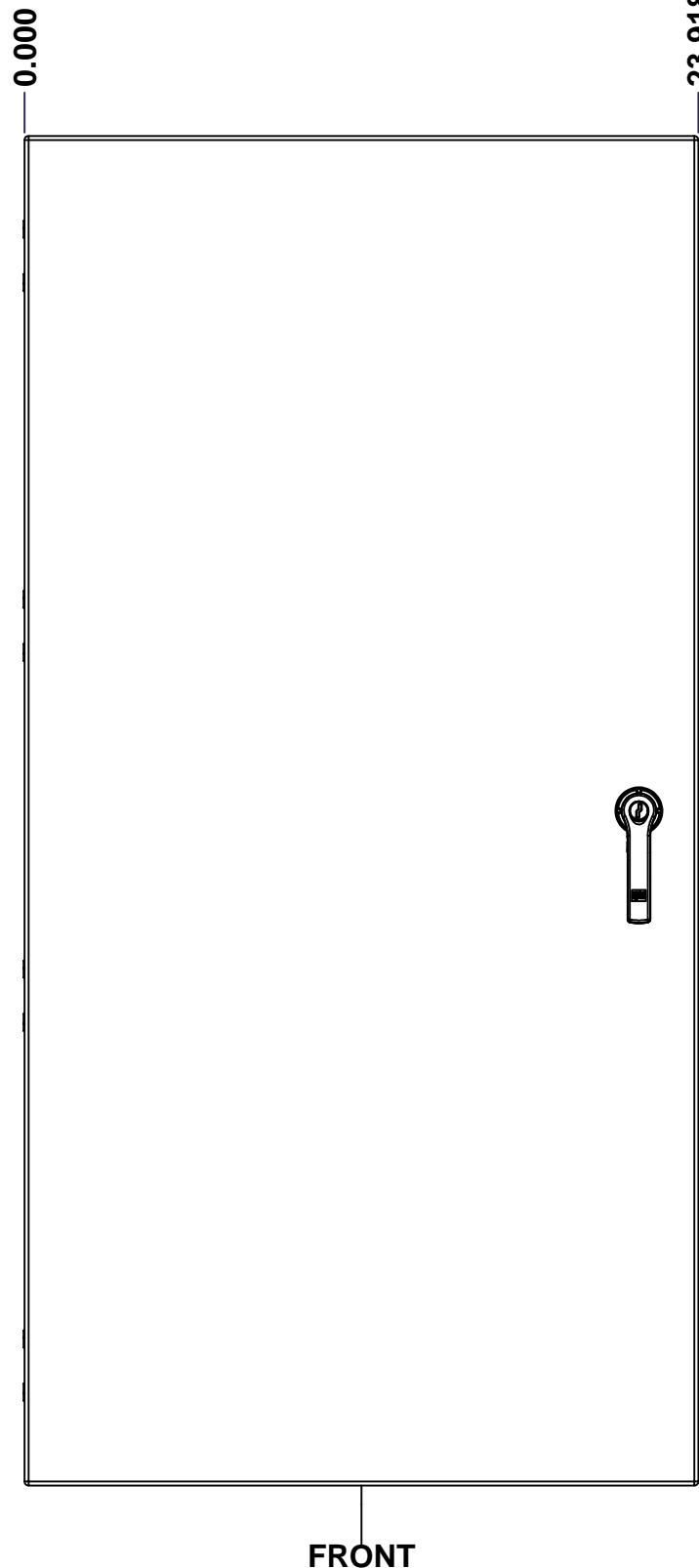
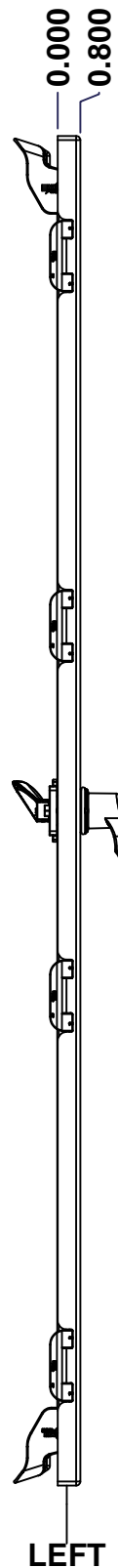
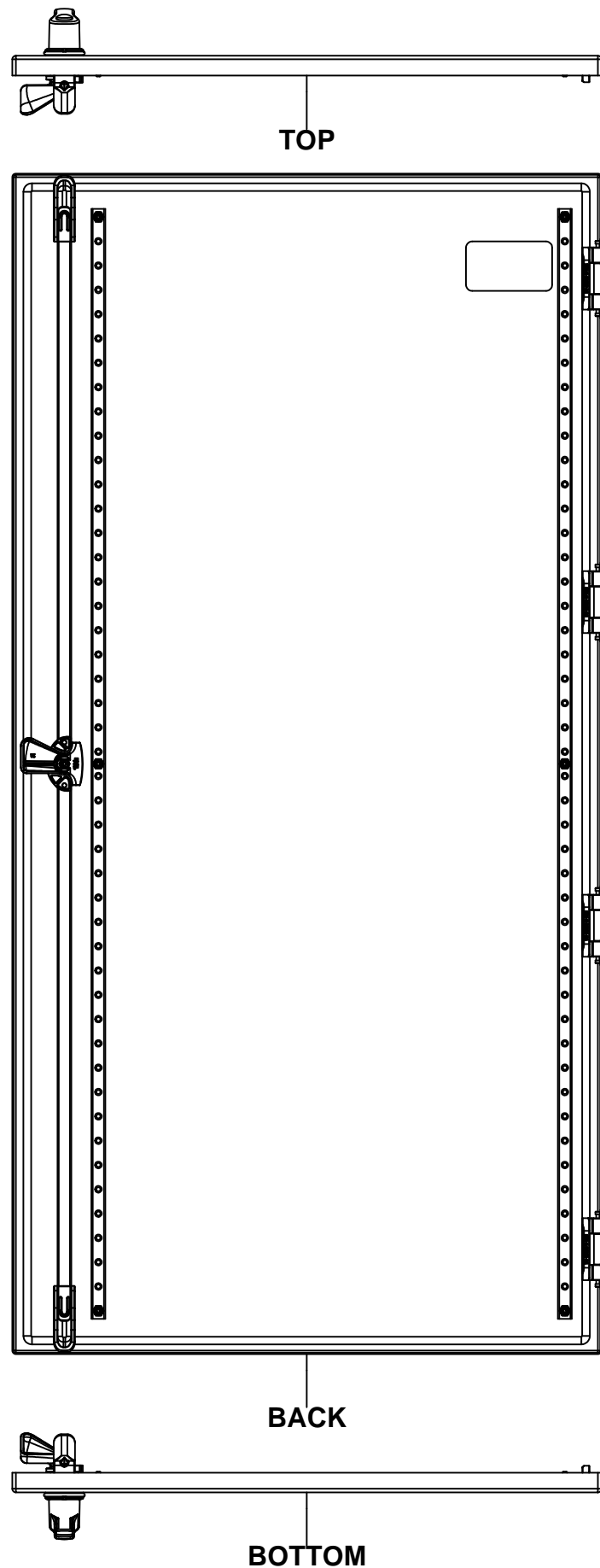

| No. | Revisions | Date | By/Par |
|-----|-----------|------|--------|
| | | | |
| | | | |
| | | | |
| | | | |
| | | | |

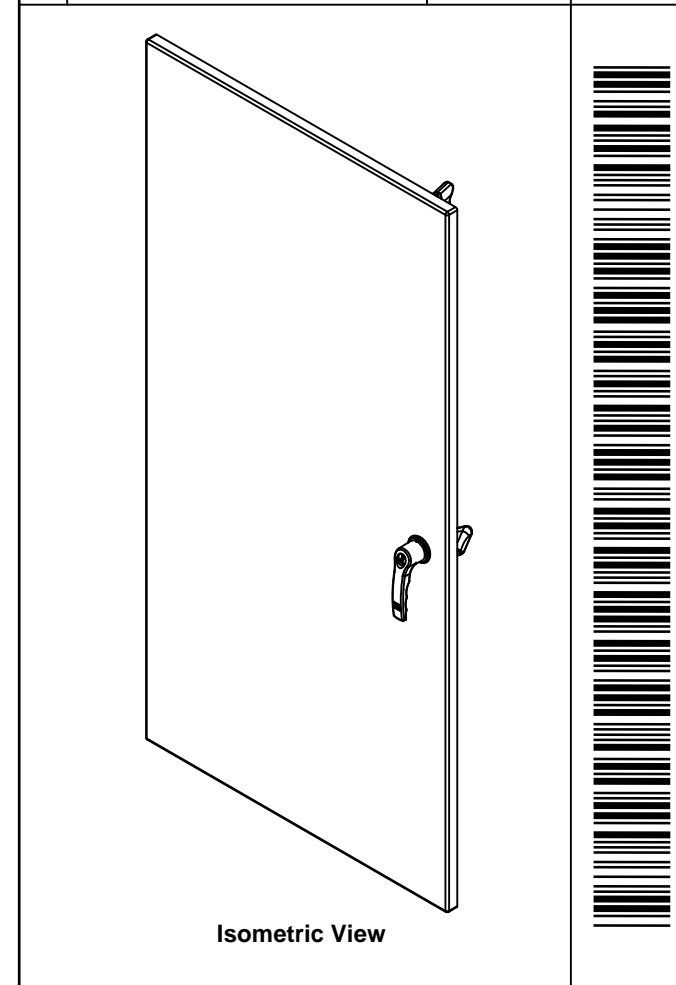

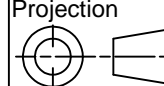
| | | |
|--|-----------------------------------|---|
|  Tél: (450) 979-4373 Fax: (450) 979-4626 www.exmweb.com | | Flatness Aplatissement Max 3.0mm Projection  |
| Customer Client | Date | Date |
| Drawn By Dessiné Par | BoxCad: BoxCad | 08-Feb-14 |
| Material Matière | 16 Ga Stainless Steel 304 (1.4mm) | |
| Color Couleur | Unpainted | Finish Fini: Brushed |
| Description | Detail Rev. | |
| 5412ESS 48" x 24" Cover | | |
| Part Number Numéro Pièce | Rev. | 1 |
| 5412ESS482408C | 0 | 3 |

SEE BILL OF MATERIAL ON LAST PAGE

This drawing is confidential and must not be reproduced or used without the consent of EXM

Ce dessin est confidentiel et ne doit pas être reproduit ou utilisé sans le consentement de EXM

| STANDARD FEATURES ARE NOT LISTED IN THIS HOLE TABLE | | | |
|---|--------|--------|-----------------------------|
| HOLE TABLE - FRONT VIEW (CUSTOM FEATURE ONLY) | | | |
| CUT-OUT | XDIM | YDIM | DESCRIPTION |
| 1 | 1.486 | 1.756 | STUD M6 x 18mm (Inside) |
| 2 | 1.486 | 46.047 | STUD M6 x 18mm (Inside) |
| 3 | 20.423 | 46.047 | STUD M6 x 18mm (Inside) |
| 4 | 20.423 | 1.756 | STUD M6 x 18mm (Inside) |
| 5 | 1.486 | 23.902 | STUD M6 x 18mm (Inside) |
| 6 | 20.423 | 23.902 | STUD M6 x 18mm (Inside) |
| 7 | 21.803 | 42.896 | CLOSING BAR STUD (Inside) |
| 8 | 21.803 | 4.907 | CLOSING BAR STUD (Inside) |
| ----- | | | |
| 9 | 3.750 | 44.053 | LABEL_EXM (Inside) |
| 10 | 21.803 | 23.902 | HANDLE 885 ESL2A-LSS @ 0.0° |

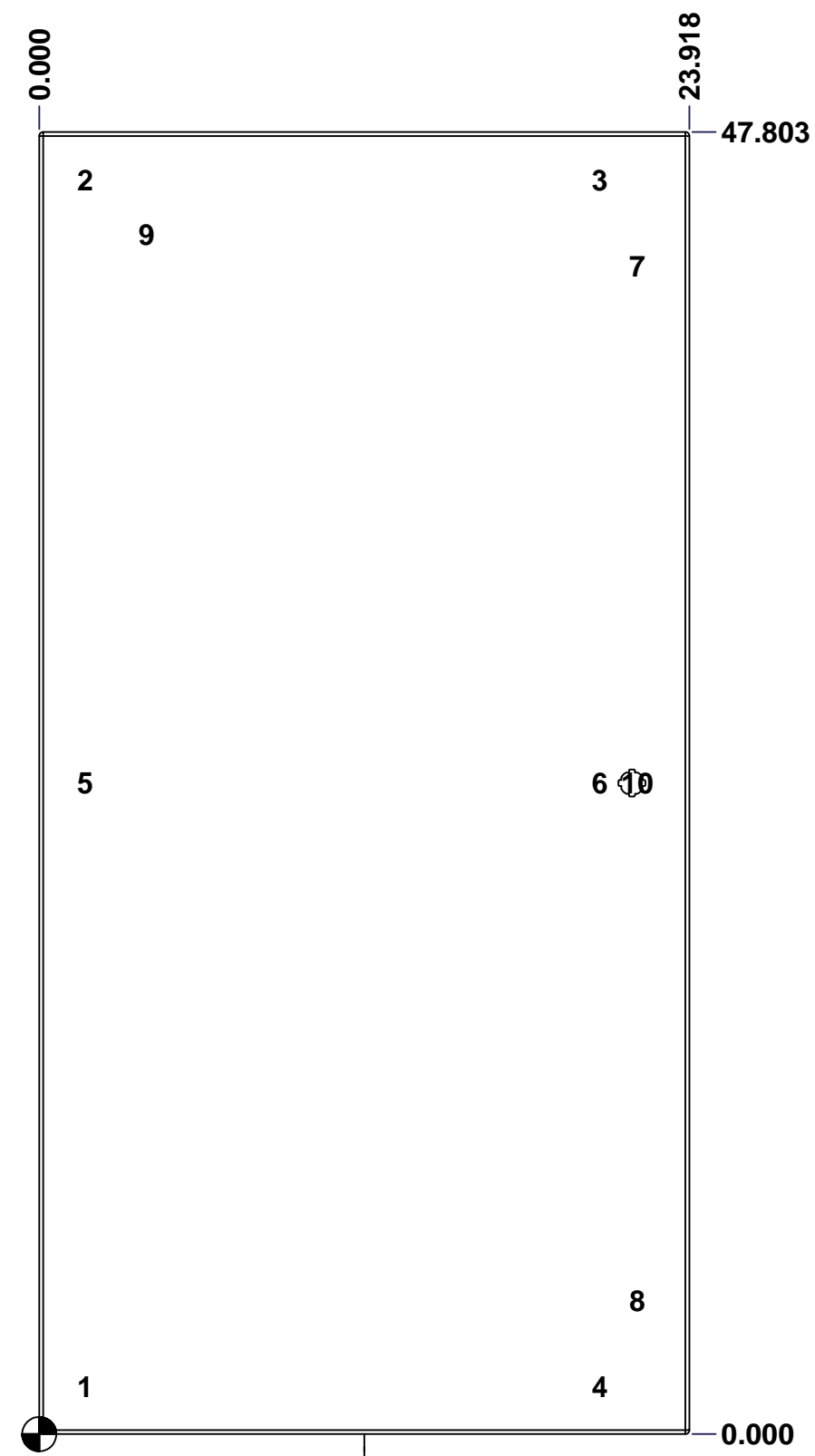

FRONT

| | | |
|--|-----------------------------|------------------|
| | Description | Status |
| | 5412ESS 48" x 24" Cover | (NULL) |
| | Part Number Numéro Pièce | Rev. |
| | 5412ESS482408C | 0 / 2 / 3 |

This drawing is confidential and must not be reproduced or used without the consent of EXM

Ce dessin est confidentiel et ne doit pas être reproduit ou utilisé sans le consentement de EXM

| No. | Revisions | Date | By/Par |
|-----|-----------|------|--------|
| | | | |
| | | | |
| | | | |
| | | | |
| | | | |

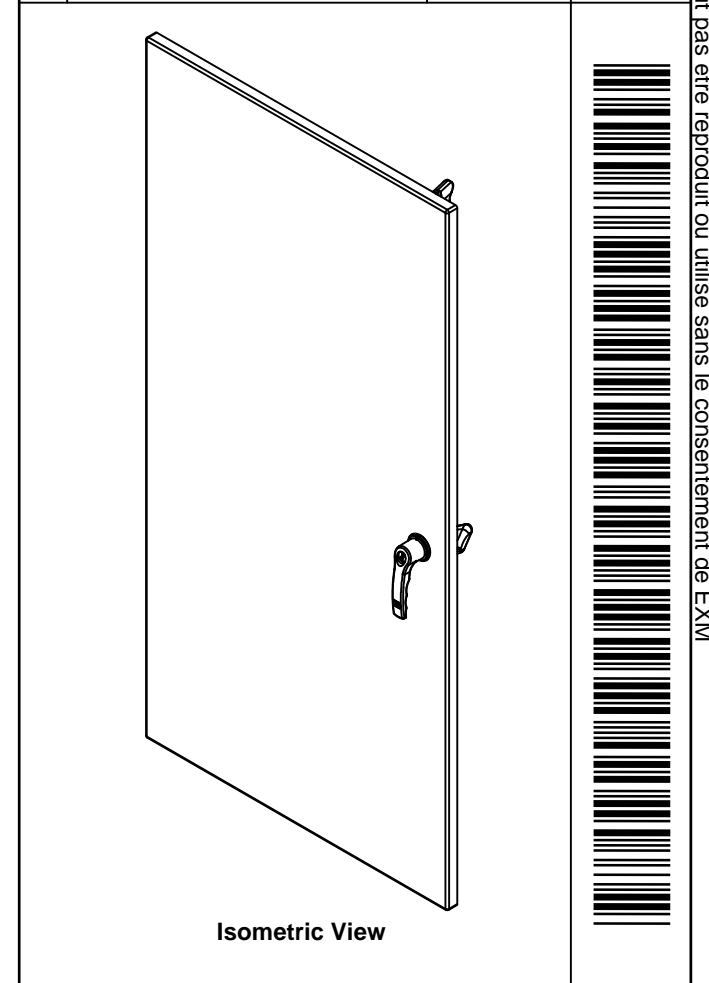

| 2 | STK-Q-90042 | 4 | 5412 ES - Cabinet Closing Bar End (Small) |
|------------|------------------|-----|--|
| 2 | STK-Q-45655-48 | 0 | 5412 ES - Closing Bar |
| 1 | STK-Q-50536 | 11 | 5412 ES - Handle Cam Clockwise (Grip 32mm) |
| 1 | 885 ESL2A-LSS | 3 | 5412 ESS Key Lock L-Handle (3 Pts) |
| 1 | STK-S-00100 | 0 | 3.5" x 2" Silver Milar Flexcon Sticker |
| 2 | STK-Q-46020-48 | 5 | 5412 ES Vertical Door Stiffener 48" |
| 2 | STK-Q-16407 | 2 | Guide Stud - Small (No Paint Cap Required) |
| 6 | STK-Q-16070 | 1 | Stud M6 x 18mm Stainless steel |
| 1 | 5412ESS482408G | 0 | 5412ESS 48" x 24" Cover Gasket Part |
| 1 | 5412ESS482408C-P | 0 | 5412ESS 48" x 24" Cover Part |
| 4 | STK-K-09850 | 6 | 5412 ESS Hinge with 2 Captive Hinge Pins |
| 6 | STK-Q-07220 | 1 | M6 Nylon Insert Lock Nut |
| Qty | Part Name | Rev | Description |
| Parts List | | | |

| | | | |
|--|--|-----------------------------------|----------------|
| Tél: (450) 979-4373 Fax: (450) 979-4626 www.exmweb.com | | Flatness Aplatissement | |
| | | Max 3.0mm | |
| Customer Client | | Date | |
| Drawn By Dessiné Par | | Date 08-Feb-14 | |
| Material Matière | | 16 Ga Stainless Steel 304 (1.4mm) | |
| Color Couleur | | Unpainted | Finish Fini |
| Description | | Detail Rev. | |
| 5412ESS 48" x 24" Cover | | | |
| Part Number Numéro Pièce | | Rev. | 3 |
| 5412ESS482408C | | 0 | 3 |

This drawing is confidential and must not be reproduced or used without the consent of EXM

Ce dessin est confidentiel et ne doit pas être reproduit ou utilisé sans le consentement de EXM

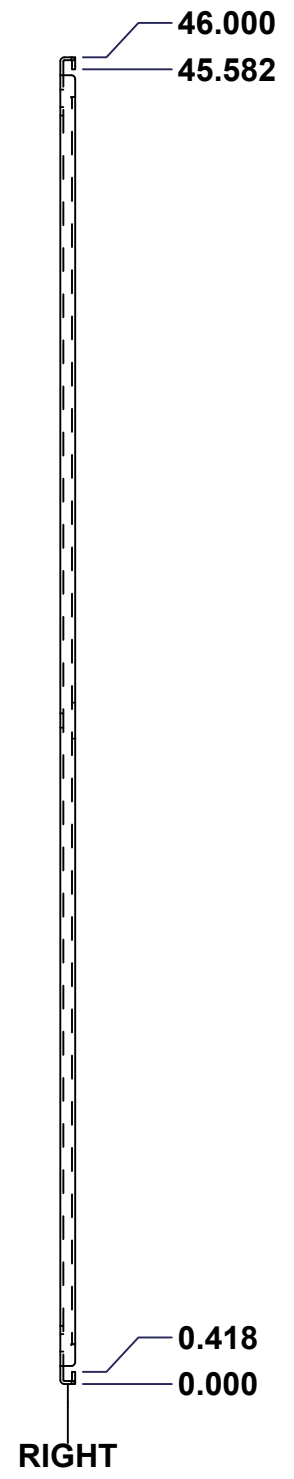
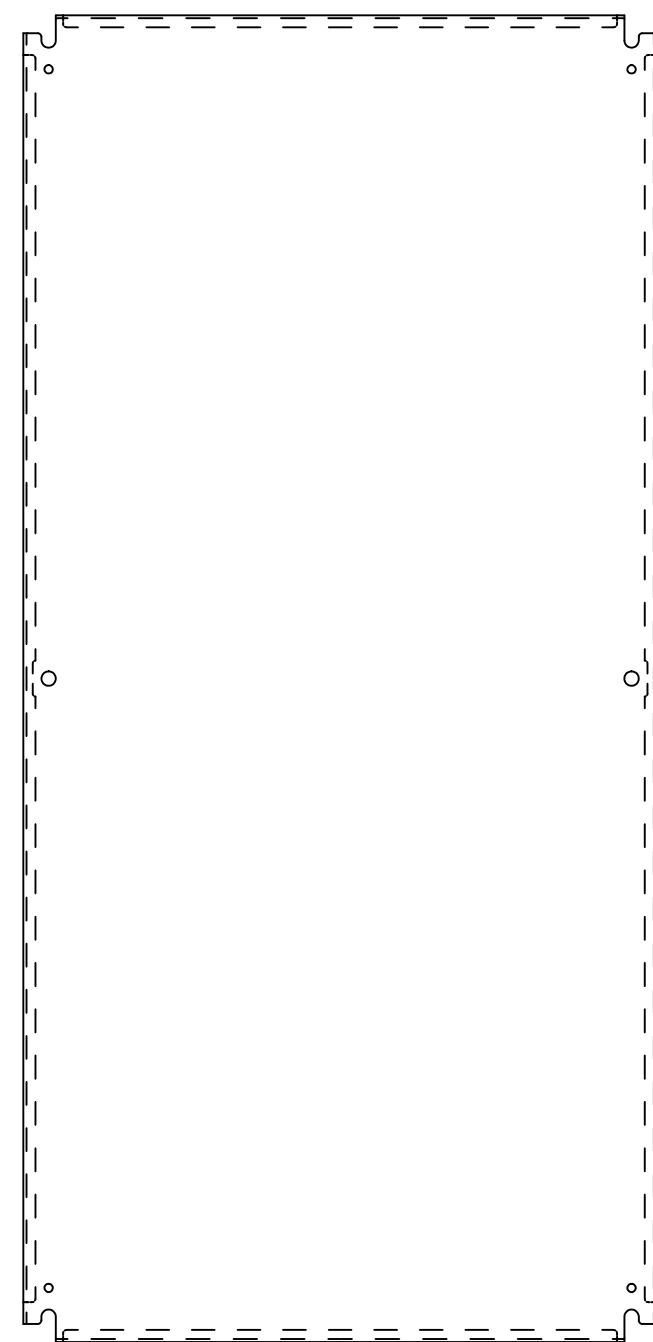
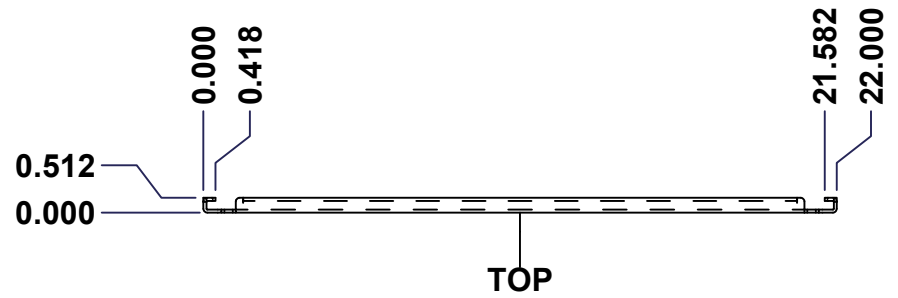

| No. | Revisions | Date | By/Par |
|-----|-----------|------|--------|
| | | | |
| | | | |
| | | | |
| | | | |
| | | | |

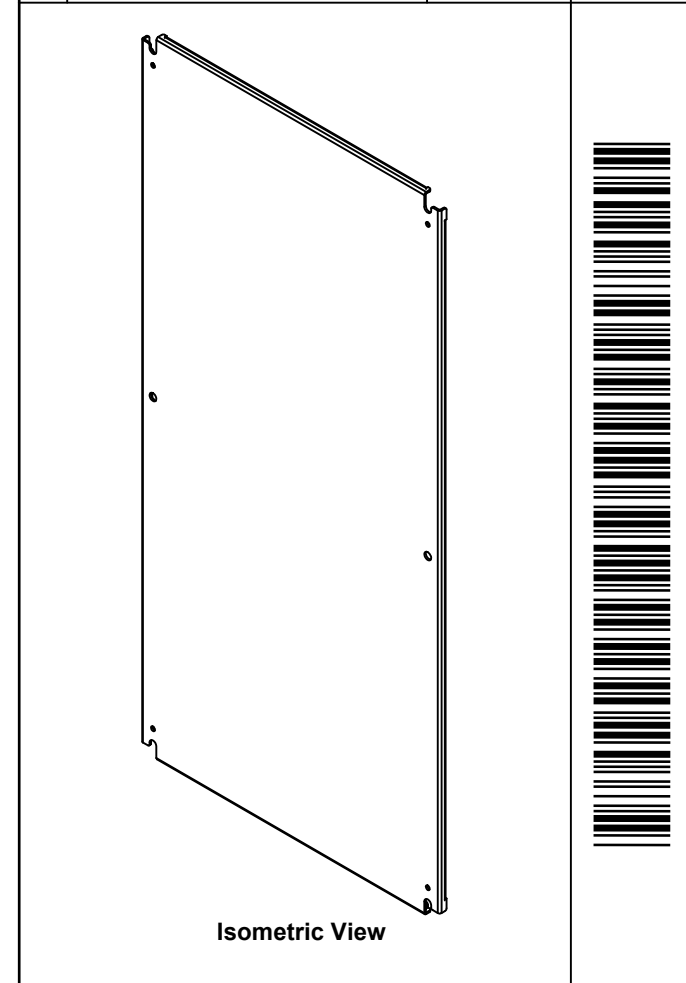

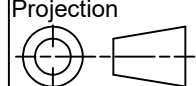
| | | |
|--|---------------|---|
|  Tél: (450) 979-4373 Fax: (450) 979-4626 www.exmweb.com | | Flatness Aplatissement Max 3.0mm Projection  |
| Customer Client | Date | |
| Drawn By Dessiné Par | BoxCad | Date 1/23/2007 |
| Material Matière | See Part List | |
| Color Couleur | See Part List | Finish Fini See Part List |
| Description | | Detail Rev. |
| 881 SP - Inner Panel | | |
| Part Number Numéro Pièce | 881 SP4824G | Rev. 1 0 |

| Qty | Part Number | Rev | Description | Material | Color | Finish |
|-----|---------------|-----|---------------------------|------------------|-----------|------------|
| 1 | 881 SP4824G-P | 0 | 881 SP - Inner Panel Part | 12 Ga Galvanized | Unpainted | Galvanized |

Parts List

This drawing is confidential and must not be reproduced or used without the consent of EXM

Ce dessin est confidentiel et ne doit pas être reproduit ou utilisé sans le consentement de EXM

| Table 1 | | | FRONT VIEW |
|---------|--------|--------|----------------------------|
| CUT-OUT | XDIM | YDIM | DESCRIPTION |
| 1 | 0.875 | 1.875 | GROUND HOLE (RND Ø0.290) |
| 2 | 21.125 | 1.875 | GROUND HOLE (RND Ø0.290) |
| 3 | 0.875 | 44.125 | GROUND HOLE (RND Ø0.290) |
| 4 | 21.125 | 44.125 | GROUND HOLE (RND Ø0.290) |
| 5 | 0.875 | 23.000 | MTG STUD HOLE (RND Ø0.500) |
| 6 | 21.125 | 23.000 | MTG STUD HOLE (RND Ø0.500) |

All knockouts are actual size / Les disques défonçables sont grandeur réel

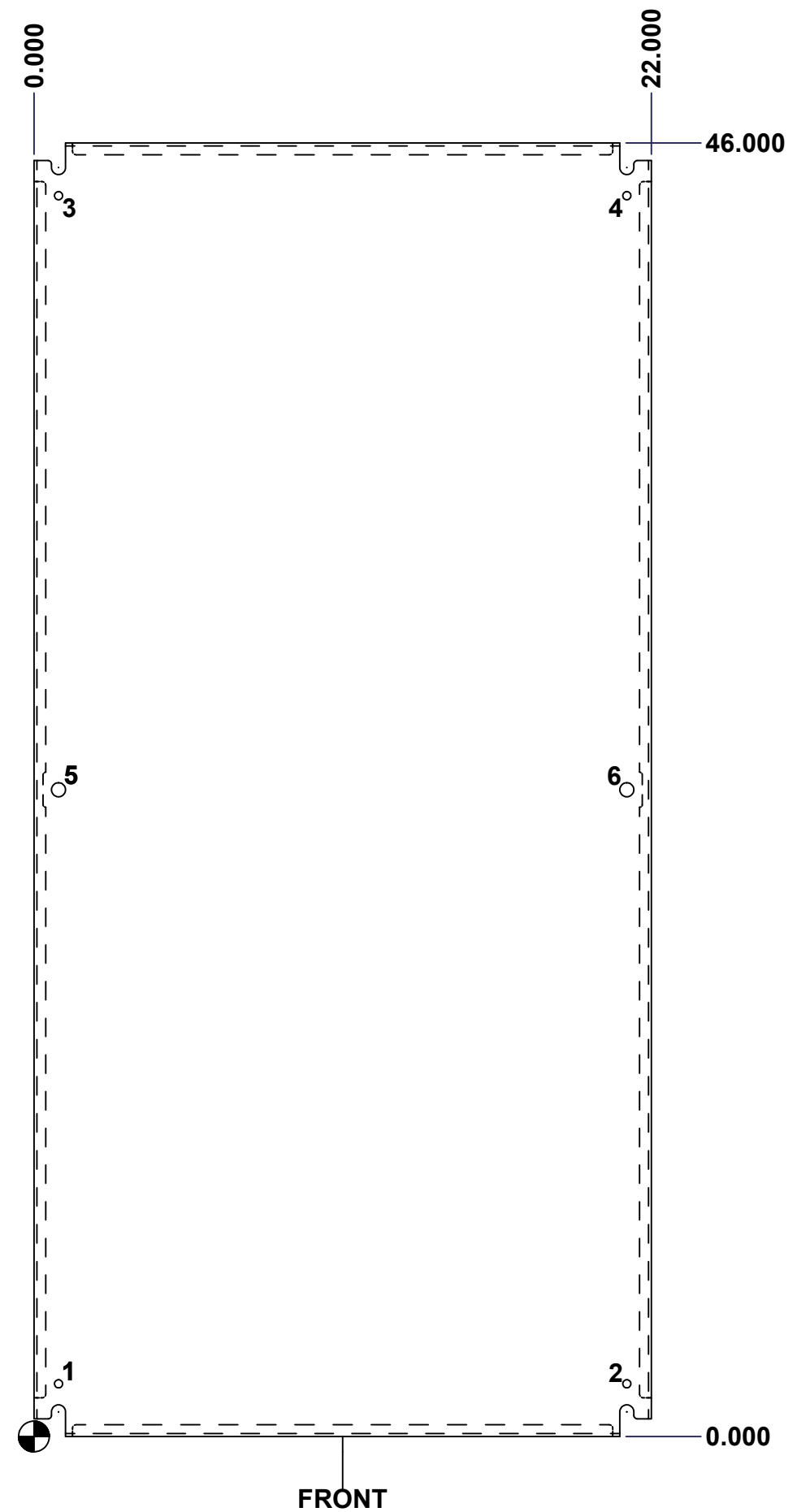

FRONT

| No. | Revisions | Date | By/Par |
|-----|-----------|------|--------|
| | | | |
| | | | |
| | | | |
| | | | |
| | | | |

Isometric View

| | | | | |
|---|--|--|--------|--|
| | | Tél: (450) 979-4373 Fax: (450) 979-4626 www.exmweb.com | | Flatness Aplatissement Max 3.0mm |
| Customer Client | | Date | | Projection |
| Drawn By Dessiné Par BoxCad | | Date 1/23/2007 | | Material Matière See Part List |
| Color Couleur See Part List | | Finish Fini See Part List | | Description 881 SP - Inner Panel |
| Part Number Numéro Pièce 881 SP4824G | | Rev. 0 | 2 2 | Detail Rev. |