

This drawing is confidential and must not be reproduced or used without the consent of EXM

Ce dessin est confidentiel et ne doit pas être reproduit ou utilisé sans le consentement de EXM

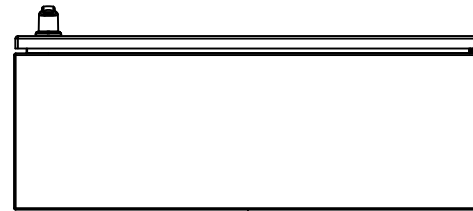

TOP

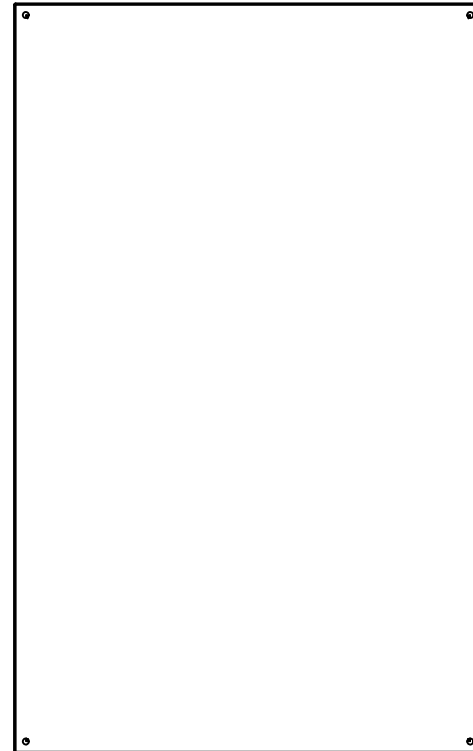

BACK

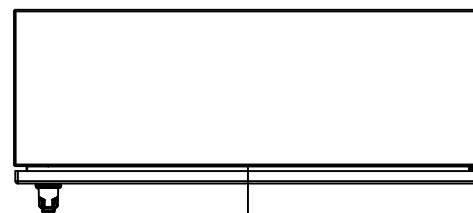

BOTTOM

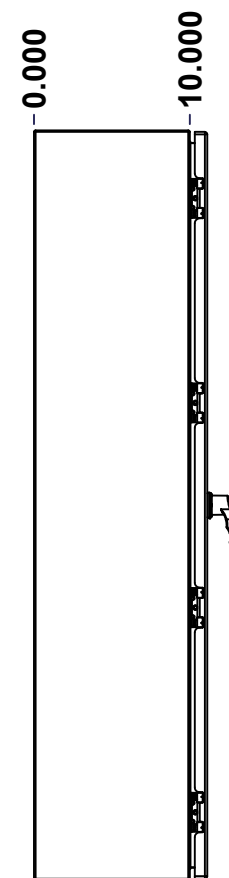

LEFT

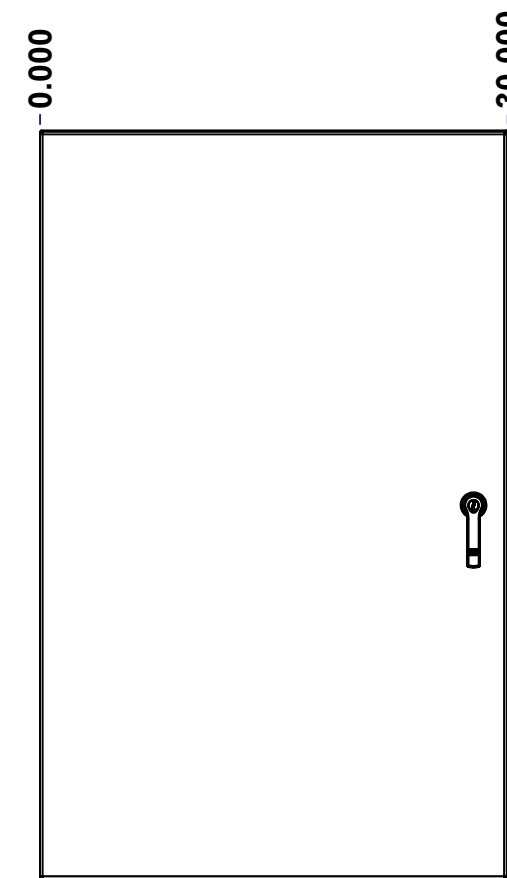

FRONT

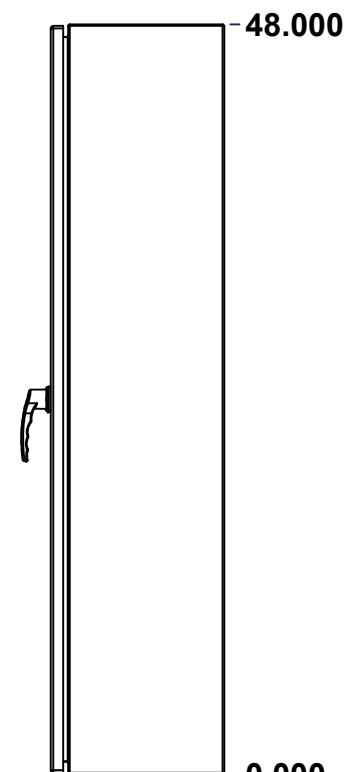

RIGHT

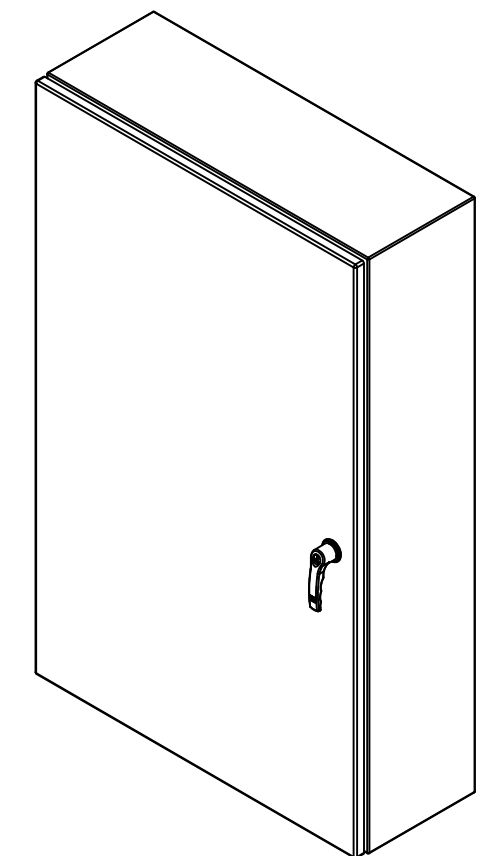

Isometric View



**GRAIN DIRECTION:
TOP/BOTTOM: HORIZONTAL
LEFT/RIGHT/BACK/FRONT: VERTICAL**

SEE BILL OF MATERIAL ON LAST PAGE

No.	Revisions	Date	By/Par

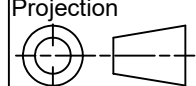
 Tél: (450) 979-4373 Fax: (450) 979-4626 www.exmweb.com		Flatness Aplatissement Max 3.0mm Projection 
Customer Client	Date	
Drawn By Dessiné Par	BoxCad: BoxCad	Date 21-Oct-21
Material Matière	14 Ga Stainless Steel 316 (1.7mm)	
Color Couleur	Unpainted	Finish Fini Brushed
Description	Detail Rev.	
5412ESS 48" x 30" x 10" Assembly		
Part Number Numéro Pièce	Rev.	1
5412ESS4830106	0	2

This drawing is confidential and must not be reproduced or used without the consent of EXM

Ce dessin est confidentiel et ne doit pas être reproduit ou utilisé sans le consentement de EXM

NOTE	
ITEM	DESCRIPTION
1	NEMA 4X Enclosure
2	C/W Standard ground studs on box and cover
3	C/W Standard door stiffener
4	C/W Standard inner panel (Included)
5	C/W Standard inner panel mounting studs

No.	Revisions	Date	By/Par

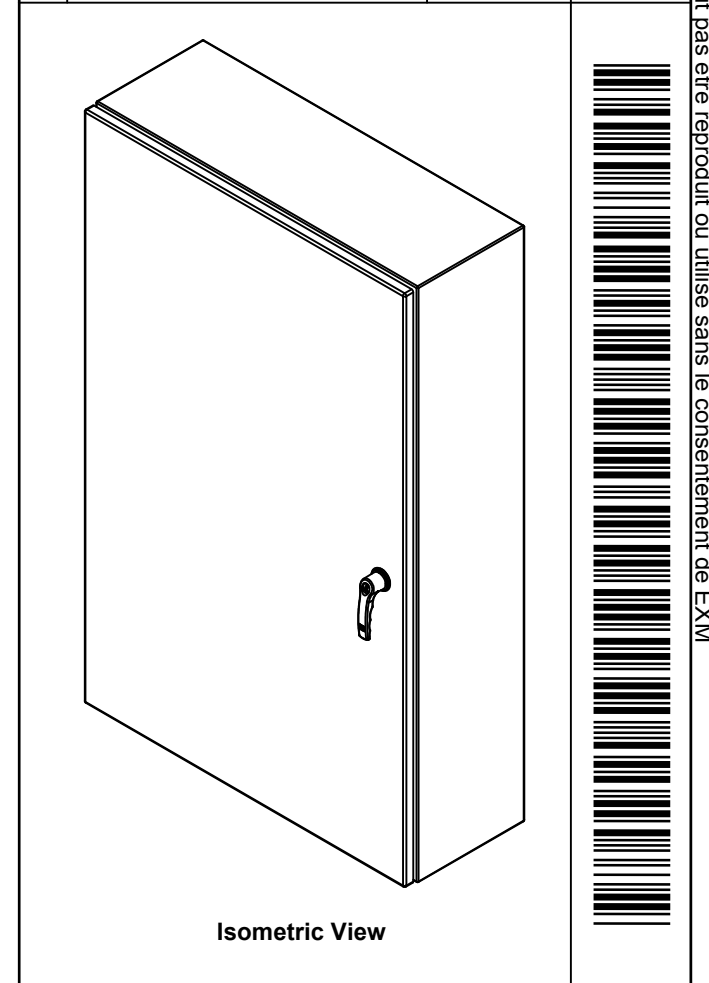

 Tél: (450) 979-4373
 Fax: (450) 979-4626
www.exmweb.com

Flatness Aplatissement
 Max 3.0mm
 Projection

PACKING		
ITEM	QTY	DESCRIPTION
Cardboard sleeve	2	Top and Bottom
Cardboard strip	2	Between back of enclosure and inner panel
Plastic bag	1	To protect cover surface and inside gasket
Cardboard corner	4	To reinforced for the plastic strap tightening
Plastic strap - Black	2	To Squeeze the 2 cardboard sleeve together
Packaging label	3	White label with PN
Plastic strap- Green	2	To secure the enclosure to the wood pallet
Wood Pallet	1	2" deeper and 3" larger than enclosure size

1	880 PP	6	Self Adhesive Print Pocket
1	STK-K-01800	5	5412 ES Accessory Kit
1	881 SP4830G	0	881 SP - Inner Panel
1	5412ESS4830106C	0	5412ESS 48" x 30" Cover
6	STK-Q-07310	2	Flange Lock Nut M8
6	STK-Q-07610	8	M8 Plastic Spacer 22.2mm
1	5412ESS4830106B	0	5412ESS 48" x 30" x 10" Body
4	STK-Q-04051-07	8	M6 x 7mm Stainless Steel Hexagon Socket Head Machine Screw with Nyseal
Qty	Part Number	Rev	Description
Parts List			

Customer Client

Drawn By Dessiné Par: BoxCad: BoxCad

Material Matière: 14 Ga Stainless Steel 316 (1.7mm)

Color Couleur: Unpainted

Finish Fini: Brushed

Description: 5412ESS 48" x 30" x 10" Assembly

Part Number Numéro Pièce: **5412ESS4830106**

Date: 21-Oct-21

Detail Rev. 0

Rev. 2

This drawing is confidential and must not be reproduced or used without the consent of EXM

Ce dessin est confidentiel et ne doit pas être reproduit ou utilisé sans le consentement de EXM

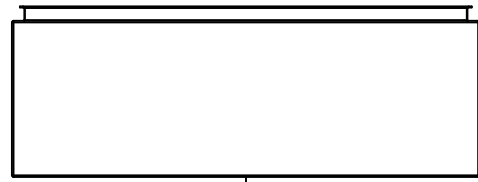

TOP

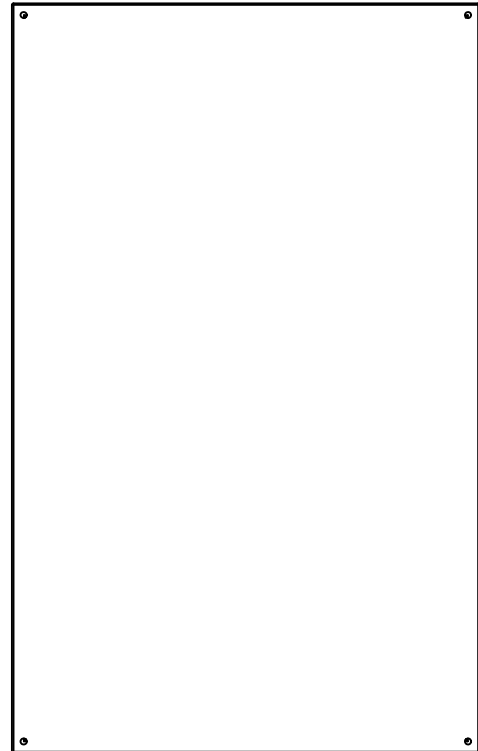

BACK

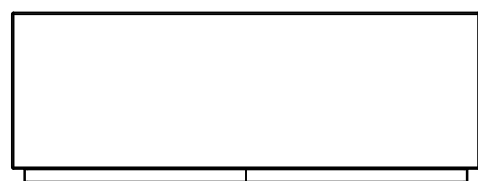

BOTTOM

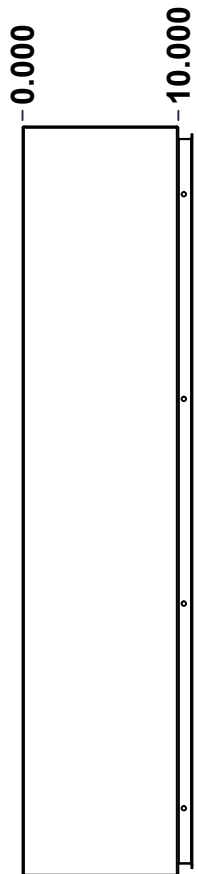

LEFT

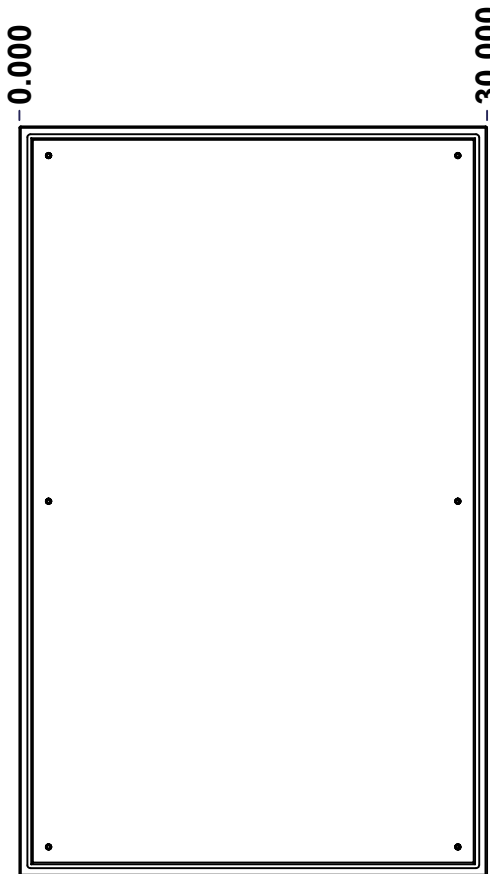

FRONT

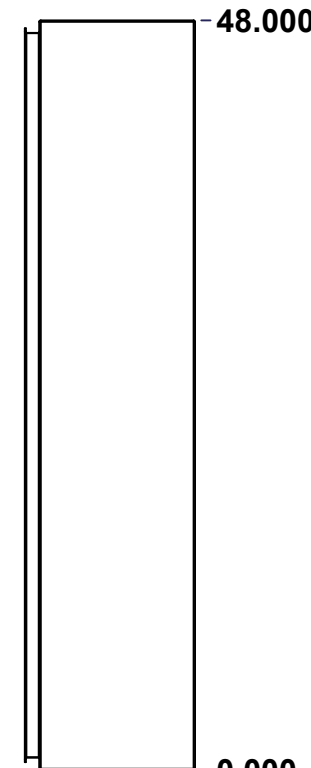

RIGHT

No.	Revisions	Date	By/Par

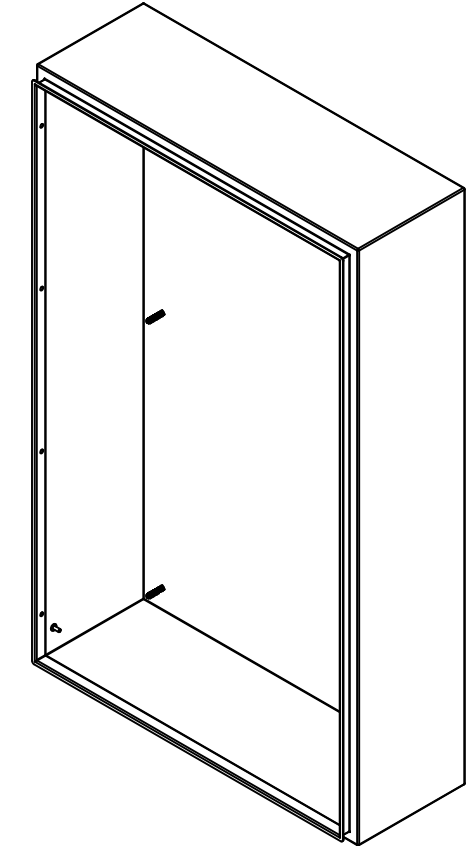

Isometric View



EXM
www.exmweb.com
Tél: (450) 979-4373
Fax: (450) 979-4626

Flatness
Aplatissement
Max 3.0mm
Projection

Customer Client
Date
Drawn By / Dessiné Par: BoxCad: BoxCad
Date: 21-Oct-21

Material Matière: 14 Ga Stainless Steel 316 (1.7mm)

Color Couleur: Unpainted
Finish Fini: Brushed

Description: 5412ESS 48" x 30" x 10" Body
Detail Rev.

Part Number / Numéro Pièce: 5412ESS4830106B
Rev. 0
1/7

SEE BILL OF MATERIAL ON LAST PAGE

This drawing is confidential and must not be reproduced or used without the consent of EXM

Ce dessin est confidentiel et ne doit pas être reproduit ou utilisé sans le consentement de EXM

STANDARD FEATURES ARE NOT LISTED IN THIS HOLE TABLE			
HOLE TABLE - LEFT VIEW (CUSTOM FEATURE ONLY)			
CUT-OUT	XDIM	YDIM	DESCRIPTION
1	8.500	2.000	GND STUD M6 x 16mm (Inside)

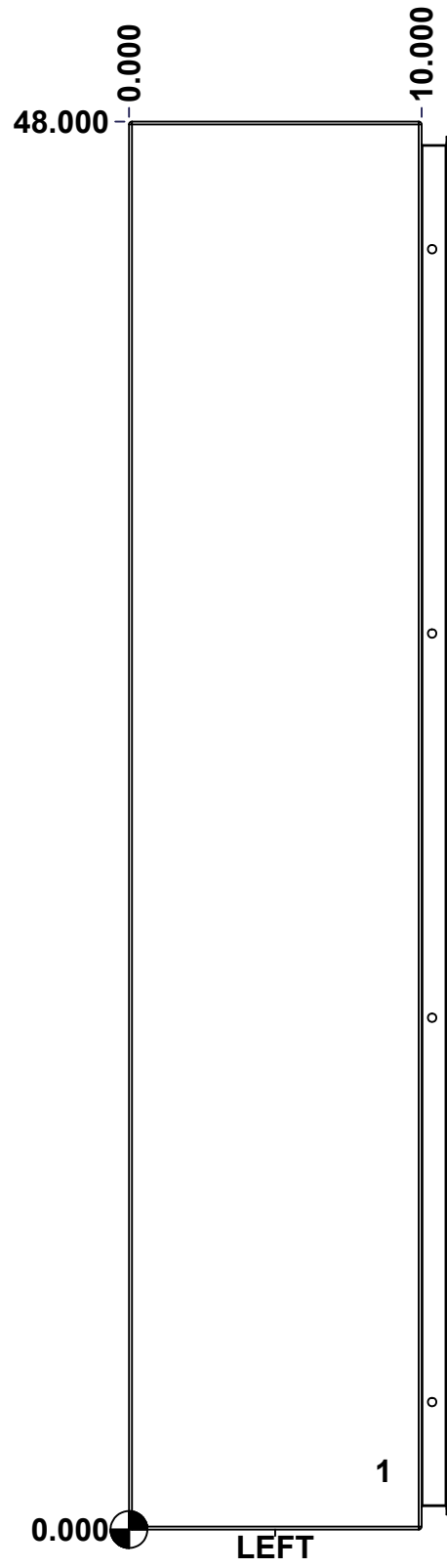

	Description	Status	
	5412ESS 48" x 30" x 10" Body		
	Part Number Numéro Pièce	Rev.	5 7
	5412ESS4830106B	0	

This drawing is confidential and must not be reproduced or used without the consent of EXM

Ce dessin est confidentiel et ne doit pas être reproduit ou utilisé sans le consentement de EXM

STANDARD FEATURES ARE NOT LISTED IN THIS HOLE TABLE

HOLE TABLE - BACK VIEW (CUSTOM FEATURE ONLY)

CUT-OUT	XDIM	YDIM	DESCRIPTION
1	1.875	1.875	IP STUD M8 x 35mm (Inside)
2	1.875	46.125	IP STUD M8 x 35mm (Inside)
3	28.125	46.125	IP STUD M8 x 35mm (Inside)
4	28.125	1.875	IP STUD M8 x 35mm (Inside)
5	1.875	24.000	IP STUD M8 x 35mm (Inside)
6	28.125	24.000	IP STUD M8 x 35mm (Inside)

7	29.250	0.750	RND Ø0.390
8	29.250	47.250	RND Ø0.390
9	0.750	47.250	RND Ø0.390
10	0.750	0.750	RND Ø0.390

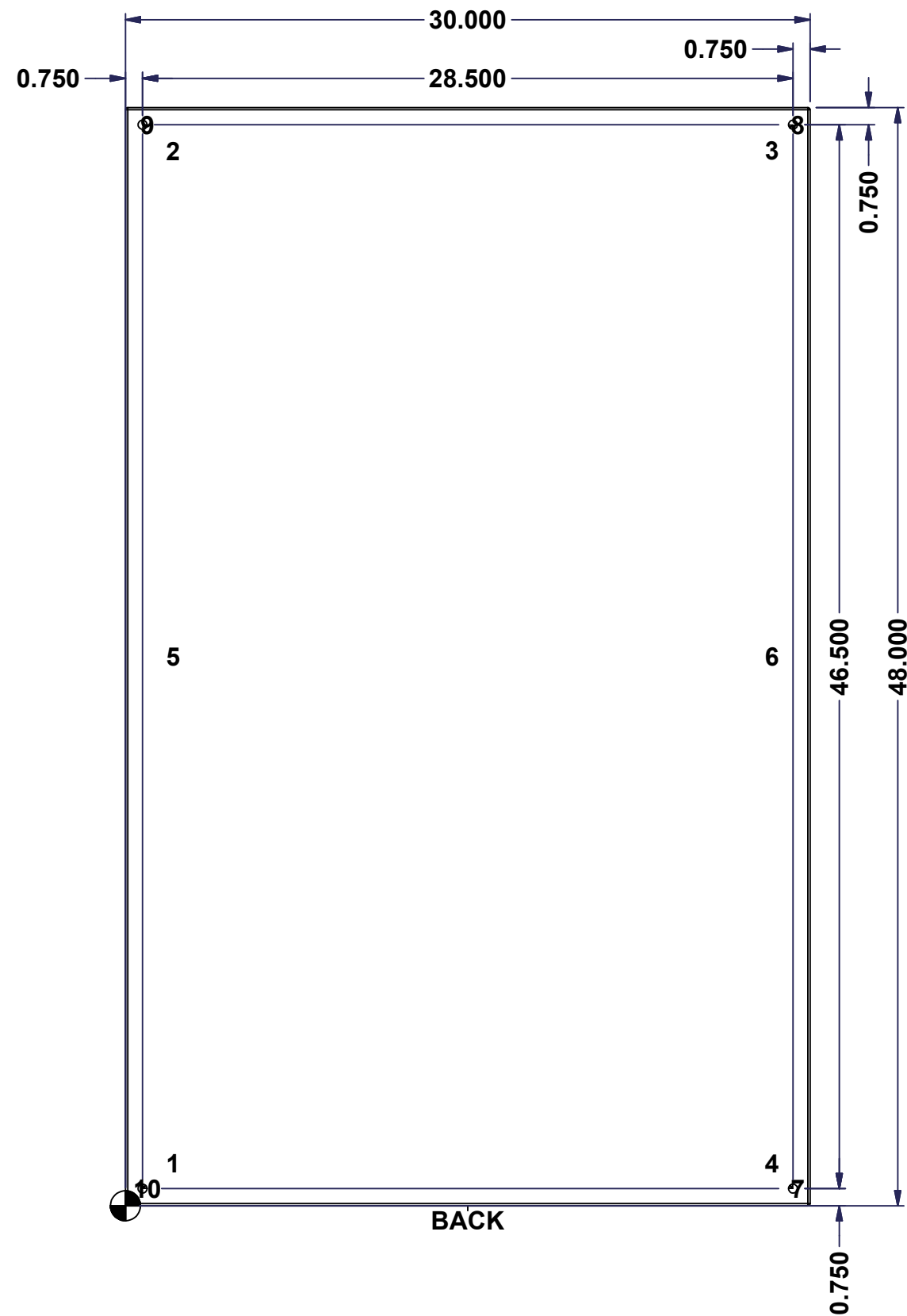



	Description	Status	
	5412ESS 48" x 30" x 10" Body		
	Part Number Numéro Pièce	Rev.	6
	5412ESS4830106B	0	7

This drawing is confidential and must not be reproduced or used without the consent of EXM

Ce dessin est confidentiel et ne doit pas être reproduit ou utilisé sans le consentement de EXM

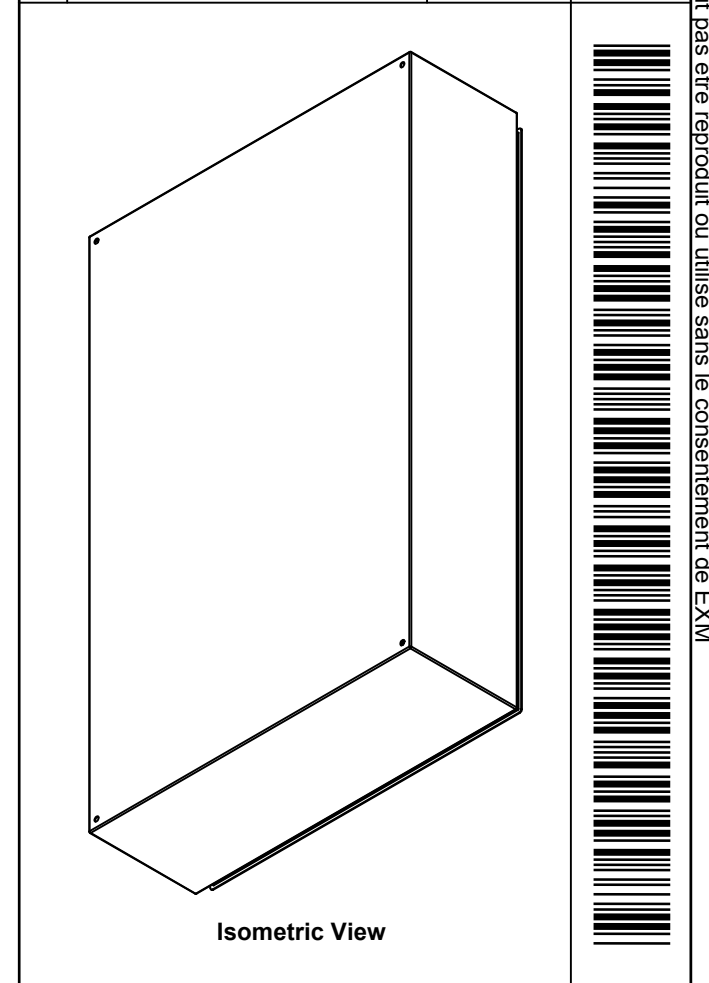
No.	Revisions	Date	By/Par



 Tél: (450) 979-4373 Fax: (450) 979-4626 www.exmweb.com		Flatness Aplatissement  Max 3.0mm
Customer Client		Date
Drawn By / Dessiné Par: BoxCad: BoxCad		Date: 21-Oct-21
Material / Matière: 14 Ga Stainless Steel 316 (1.7mm)		
Color / Couleur: Unpainted		Finish / Fini: Brushed
Description: 5412ESS 48" x 30" x 10" Body		Detail Rev.
Part Number / Numéro Pièce: 5412ESS4830106B		Rev. 7 0

Qty	Part Number	Rev	Description
1	STK-Q-16085	0	Ground Stud M6 x 16mm Stainless Steel
6	STK-Q-16020	1	Stud M8 x 35mm Stainless Steel
1	5412ESS4830106B-P	0	5412ESS 48" x 30" x 10" Body Part
Parts List			

This drawing is confidential and must not be reproduced or used without the consent of EXM

Ce dessin est confidentiel et ne doit pas être reproduit ou utilisé sans le consentement de EXM

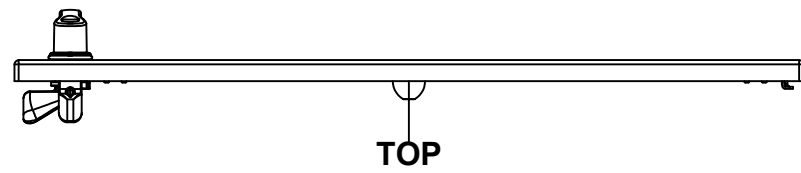

TOP

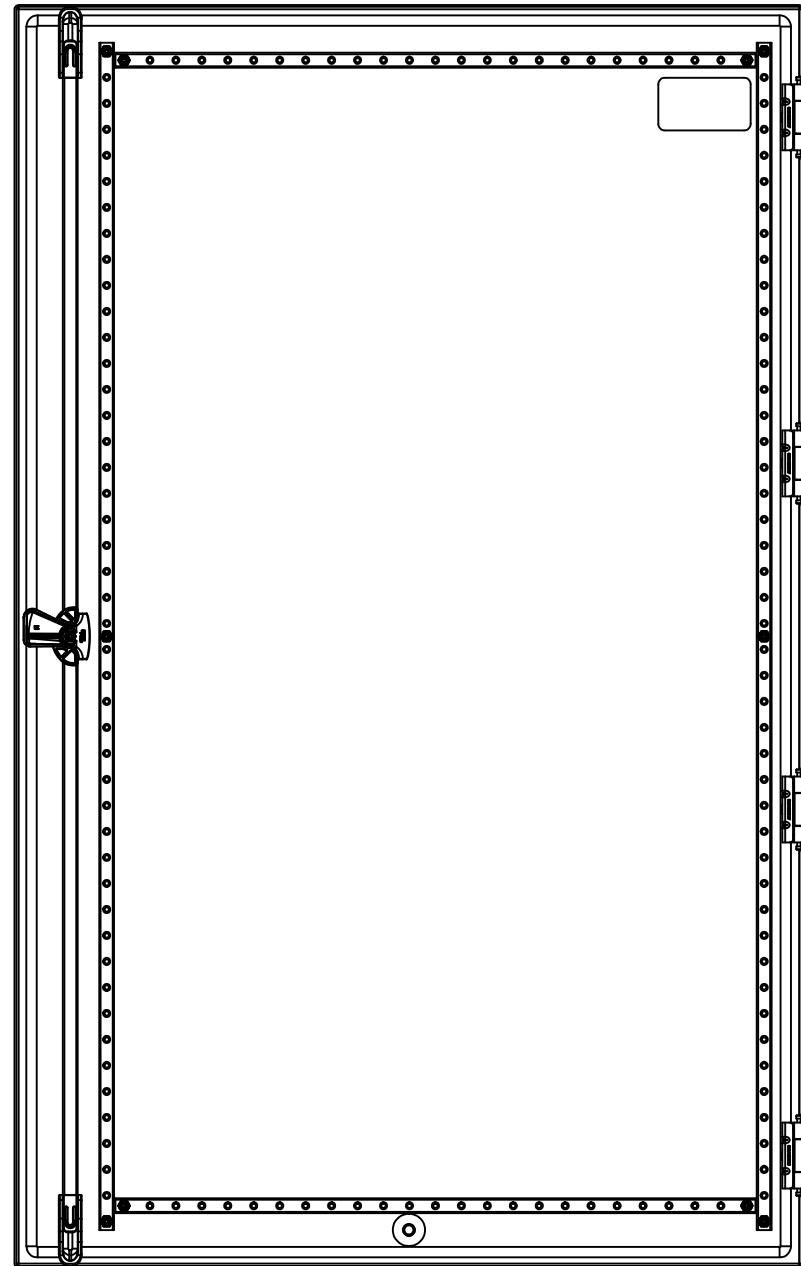

BACK

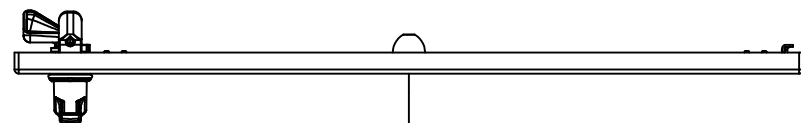

BOTTOM

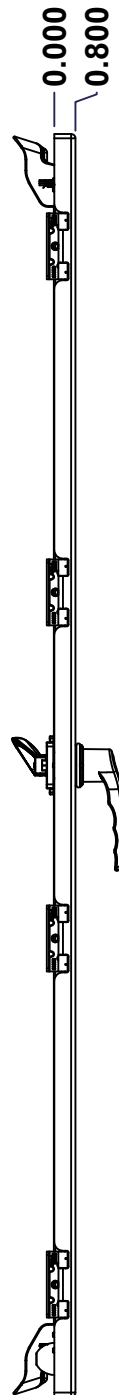

LEFT

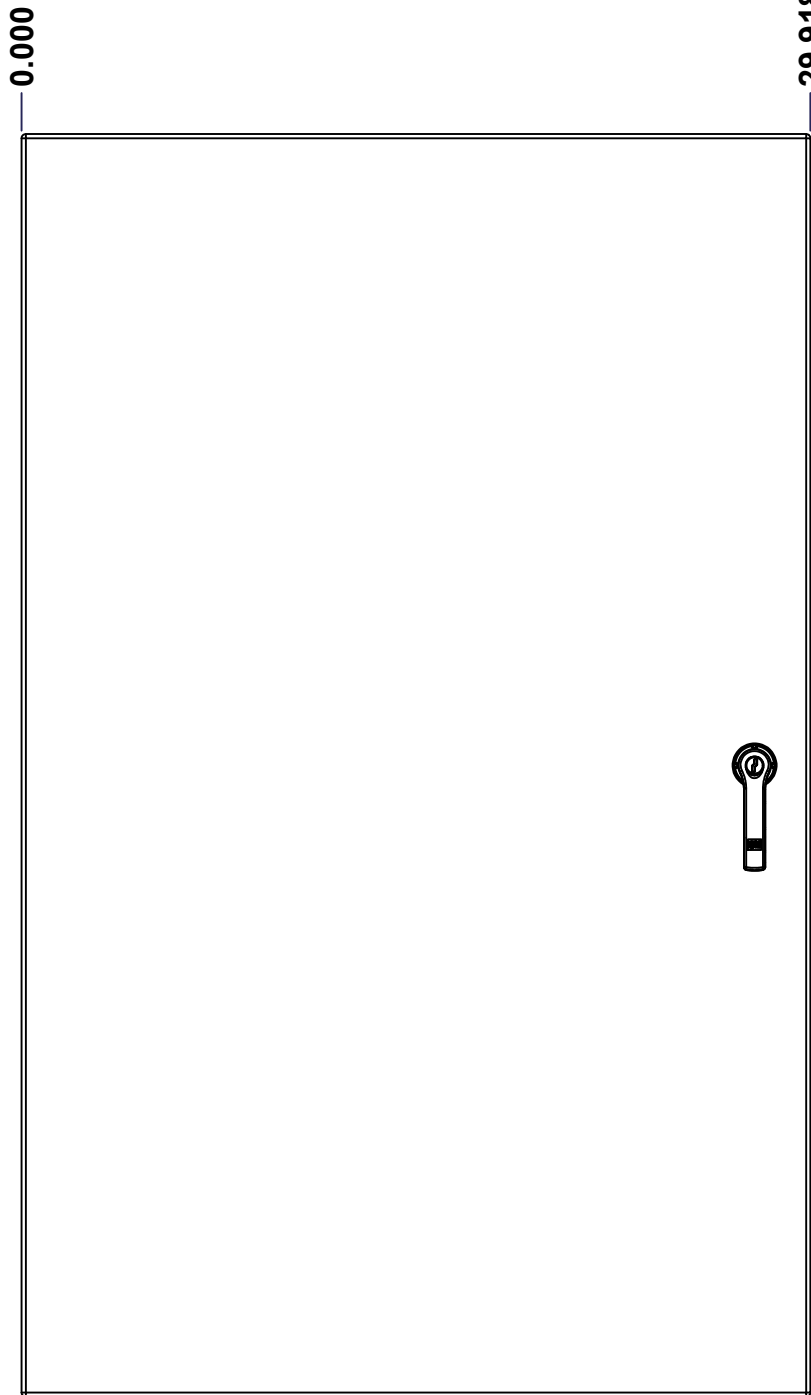

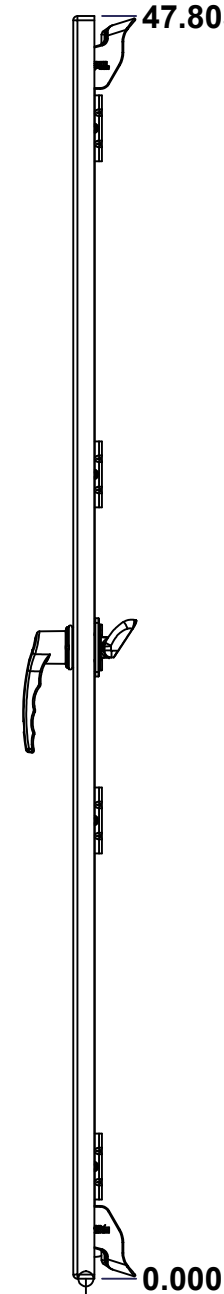

FRONT

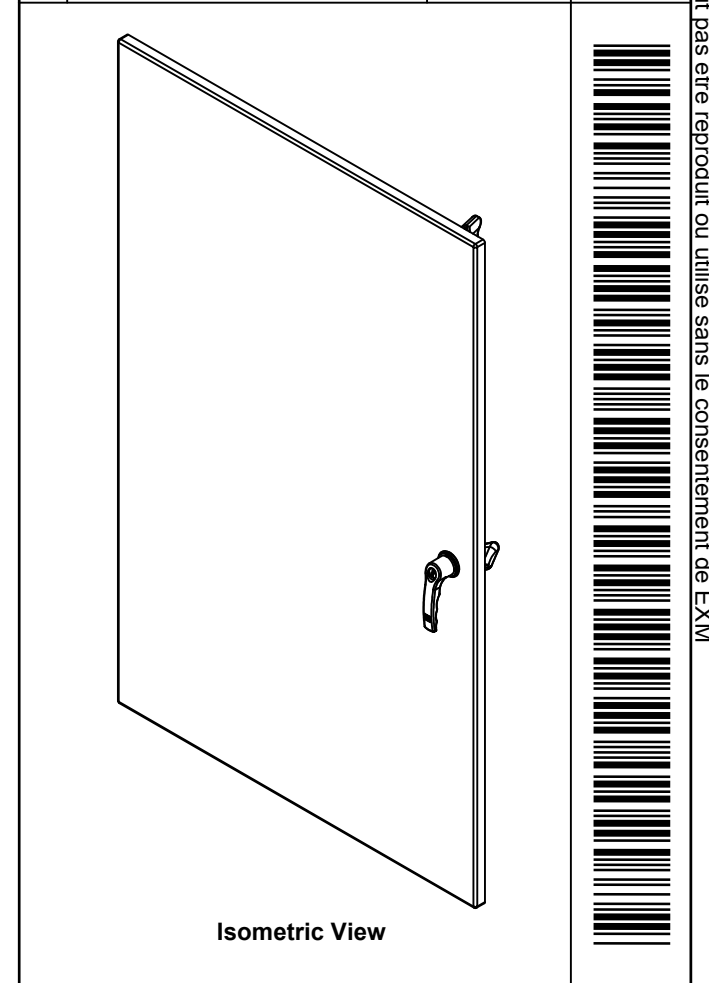

RIGHT

No.	Revisions	Date	By/Par



 Tél: (450) 979-4373 Fax: (450) 979-4626 www.exmweb.com		Flatness Aplatissement	
		Max 3.0mm	
Customer Client		Date	
Drawn By Dessiné Par BoxCad: BoxCad		Date 21-Oct-21	
Material Matière 14 Ga Stainless Steel 316 (1.7mm)		Projection	
Color Couleur Unpainted		Finish Fini Brushed	
Description 5412ESS 48" x 30" Cover		Detail Rev.	
Part Number Numéro Pièce 5412ESS4830106C		Rev. 0	1 3

SEE BILL OF MATERIAL ON LAST PAGE

This drawing is confidential and must not be reproduced or used without the consent of EXM

Ce dessin est confidentiel et ne doit pas être reproduit ou utilisé sans le consentement de EXM

STANDARD FEATURES ARE NOT LISTED IN THIS HOLE TABLE

HOLE TABLE - FRONT VIEW (CUSTOM FEATURE ONLY)

CUT-OUT	XDIM	YDIM	DESCRIPTION
1	1.486	1.756	STUD M6 x 18mm (Inside)
2	1.486	46.047	STUD M6 x 18mm (Inside)
3	26.423	46.047	STUD M6 x 18mm (Inside)
4	26.423	1.756	STUD M6 x 18mm (Inside)
5	1.486	23.902	STUD M6 x 18mm (Inside)
6	26.423	23.902	STUD M6 x 18mm (Inside)
7	2.143	2.350	STUD M6 x 18mm (Inside)
8	2.143	45.713	STUD M6 x 18mm (Inside)
9	25.766	45.713	STUD M6 x 18mm (Inside)
10	25.766	2.350	STUD M6 x 18mm (Inside)
11	27.803	42.896	CLOSING BAR STUD (Inside)
12	27.803	4.907	CLOSING BAR STUD (Inside)
13	14.959	1.435	STUD M6 x 18mm (Inside)

14	3.750	44.053	LABEL_EXM (Inside)
15	27.803	23.902	HANDLE 885 ESL2A-LSS @ 0.0°

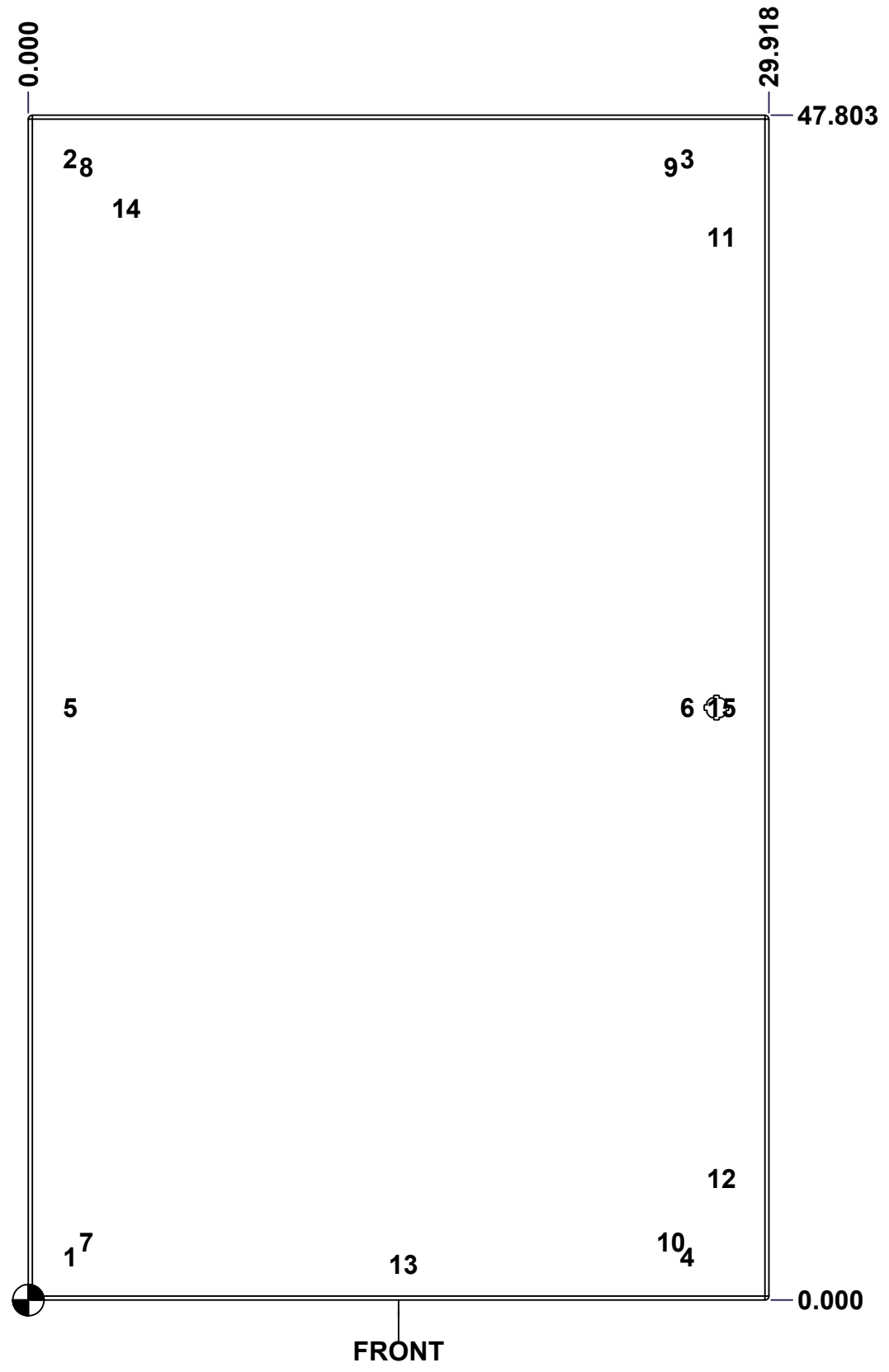

	Description		Status	
	5412ESS 48" x 30" Cover		(NULL)	
Part Number Numéro Pièce		Rev.	2	
5412ESS4830106C		0	3	

This drawing is confidential and must not be reproduced or used without the consent of EXM

Ce dessin est confidentiel et ne doit pas être reproduit ou utilisé sans le consentement de EXM

No.	Revisions	Date	By/Par

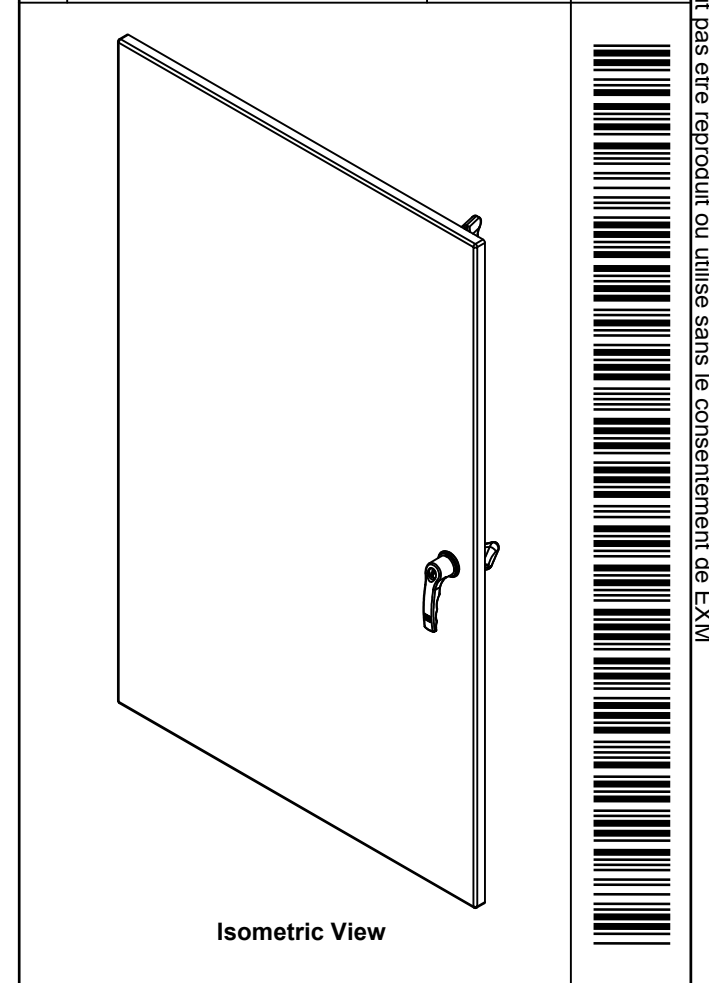

2	STK-Q-90042	4	5412 ES - Cabinet Closing Bar End (Small)
2	STK-Q-45655-48	0	5412 ES - Closing Bar
1	STK-Q-50536	13	5412 ES - Handle Cam Clockwise (Grip 32mm)
1	885 ESL2A-LSS	3	5412 ESS Key Lock L-Handle (3 Pts)
1	STK-S-00100	0	3.5" x 2" Silver Milar Flexcon Sticker
1	STK-Q-46515	3	5412 ES Door Support with Brass Insert
2	STK-Q-46025-30-3	4	5412 ES Horizontal Door Stiffener 30" (3Pts)
2	STK-Q-46020-48	5	5412 ES Vertical Door Stiffener 48"
2	STK-Q-16407	2	Guide Stud - Small (No Paint Cap Required)
11	STK-Q-16070	1	Stud M6 x 18mm Stainless steel
1	5412ESS4830106G	0	5412ESS 48" x 30" Cover Gasket Part
1	5412ESS4830106C-P	0	5412ESS 48" x 30" Cover Part
4	STK-A-33016	0	5412 ESS Bended Hinge (Body Part)
10	STK-Q-07220	1	M6 Nylon Insert Lock Nut
Qty	Part Name	Rev	Description
Parts List			

<p>Tél: (450) 979-4373 Fax: (450) 979-4626 www.exmweb.com</p>	Flatness Aplatissement	Max 3.0mm
	Projection	
Customer Client	Date	
Drawn By Dessiné Par	BoxCad: BoxCad	Date 21-Oct-21
Material Matière	14 Ga Stainless Steel 316 (1.7mm)	
Color Couleur	Unpainted	Finish Fini Brushed
Description	Detail Rev.	
5412ESS 48" x 30" Cover		
Part Number Numéro Pièce	Rev. 0	3
5412ESS4830106C		3

This drawing is confidential and must not be reproduced or used without the consent of EXM

Ce dessin est confidentiel et ne doit pas être reproduit ou utilisé sans le consentement de EXM

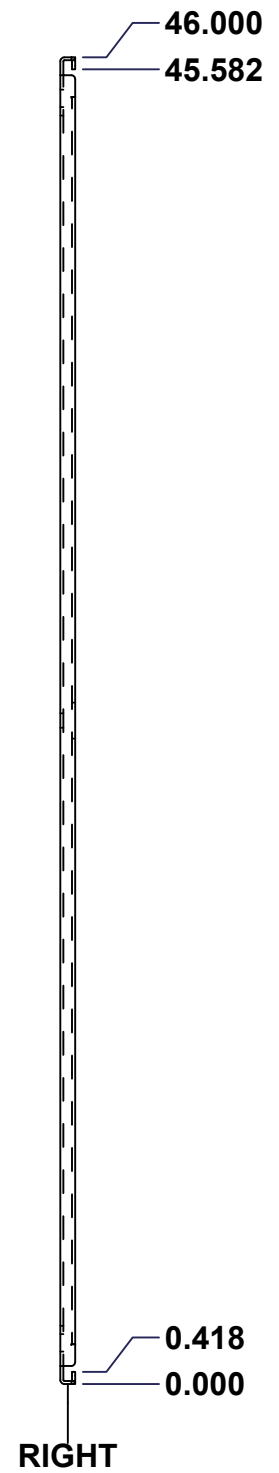
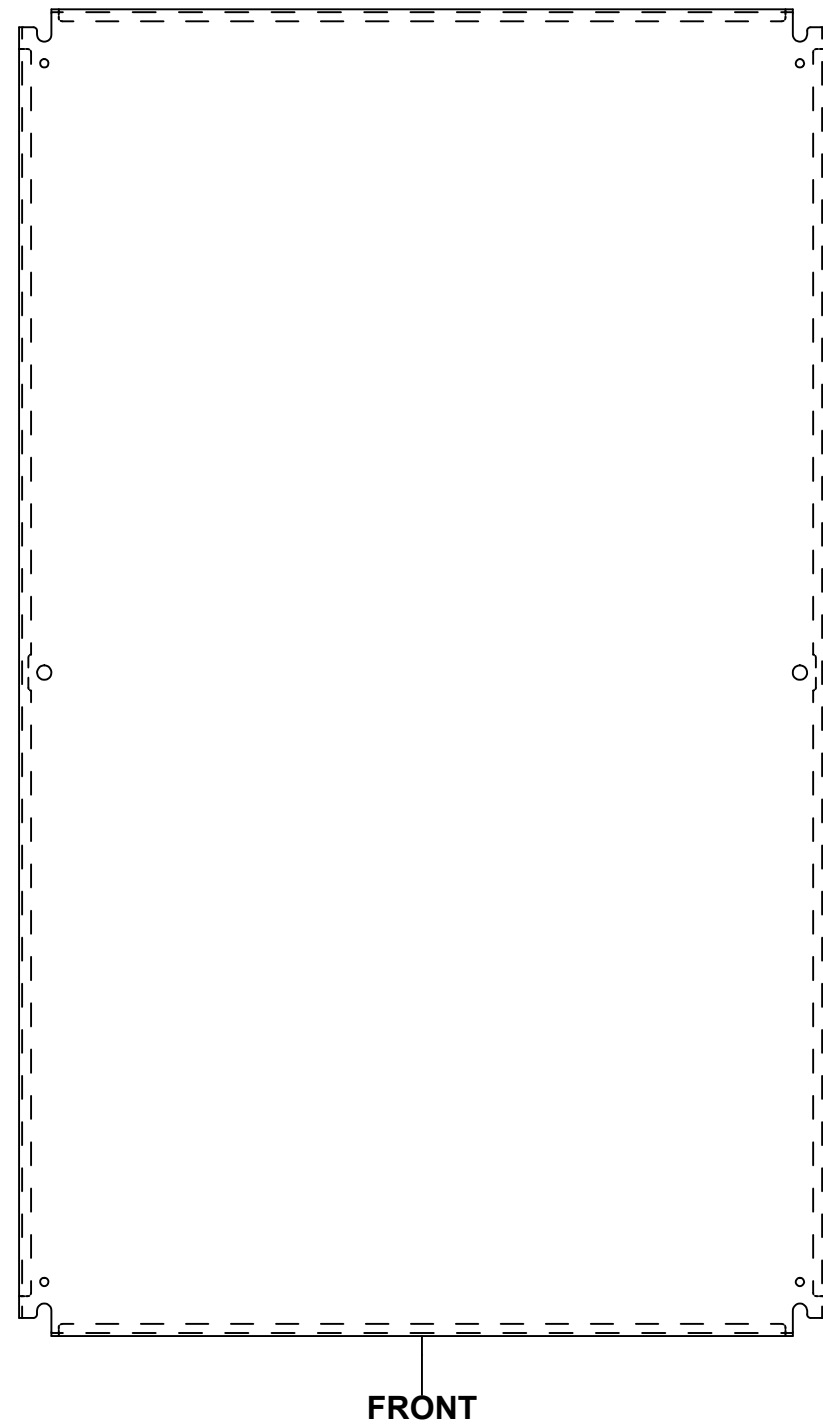
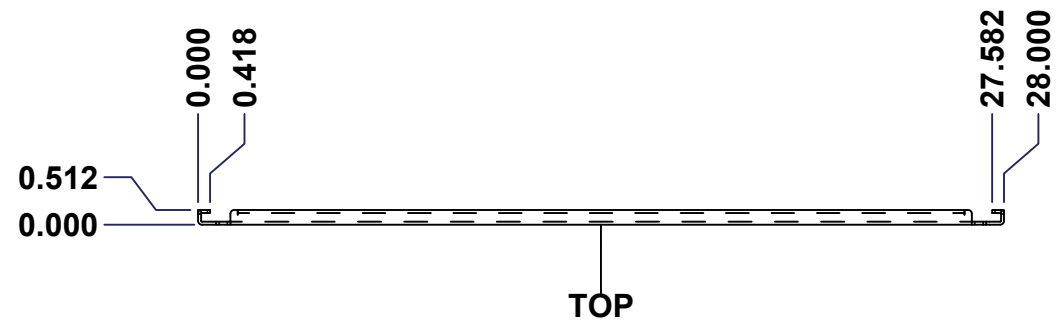

No.	Revisions	Date	By/Par

Isometric View

Tél: (450) 979-4373 Fax: (450) 979-4626 www.exmweb.com		Flatness Aplatissement Max 3.0mm Projection
Customer Client	Date	
Drawn By Dessiné Par	BoxCad	Date 1/23/2007
Material Matière	See Part List	
Color Couleur	See Part List	Finish Fini See Part List
Description		Detail Rev.
881 SP - Inner Panel		
Part Number Numéro Pièce	881 SP4830G	Rev. 1 0

Qty	Part Number	Rev	Description	Material	Color	Finish
1	881 SP4830G-P	0	881 SP - Inner Panel Part	12 Ga Galvanized	Unpainted	Galvanized

Parts List

This drawing is confidential and must not be reproduced or used without the consent of EXM

Ce dessin est confidentiel et ne doit pas être reproduit ou utilisé sans le consentement de EXM

Table 1			FRONT VIEW
CUT-OUT	XDIM	YDIM	DESCRIPTION
1	0.875	1.875	GROUND HOLE (RND Ø0.290)
2	27.125	1.875	GROUND HOLE (RND Ø0.290)
3	0.875	44.125	GROUND HOLE (RND Ø0.290)
4	27.125	44.125	GROUND HOLE (RND Ø0.290)
5	0.875	23.000	MTG STUD HOLE (RND Ø0.500)
6	27.125	23.000	MTG STUD HOLE (RND Ø0.500)

All knockouts are actual size / Les disques défonçables sont grandeur réel

No.	Revisions	Date	By/Par

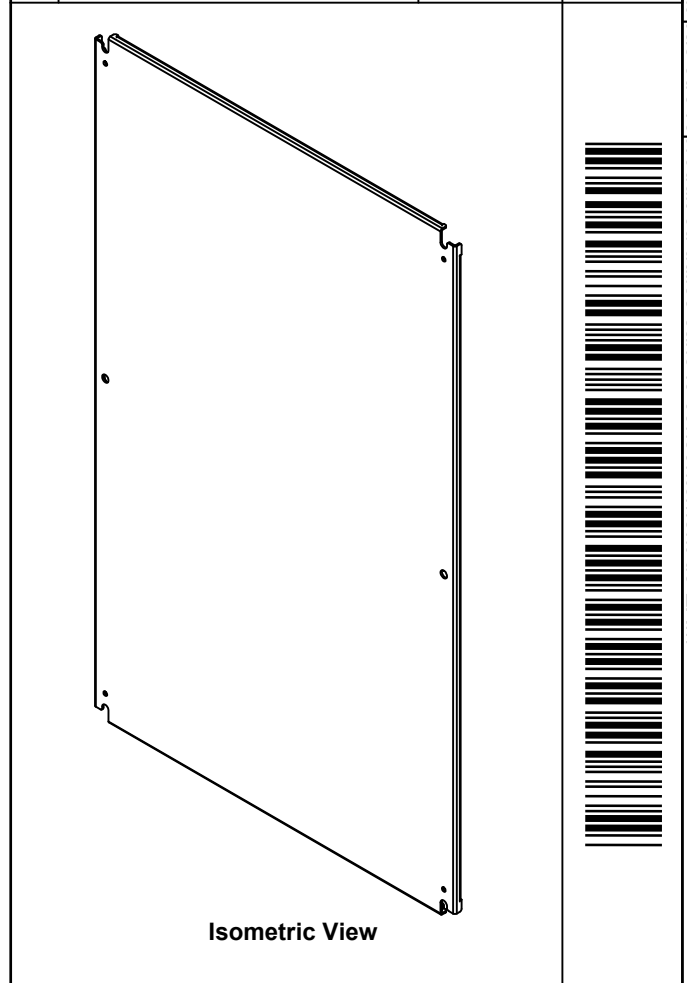
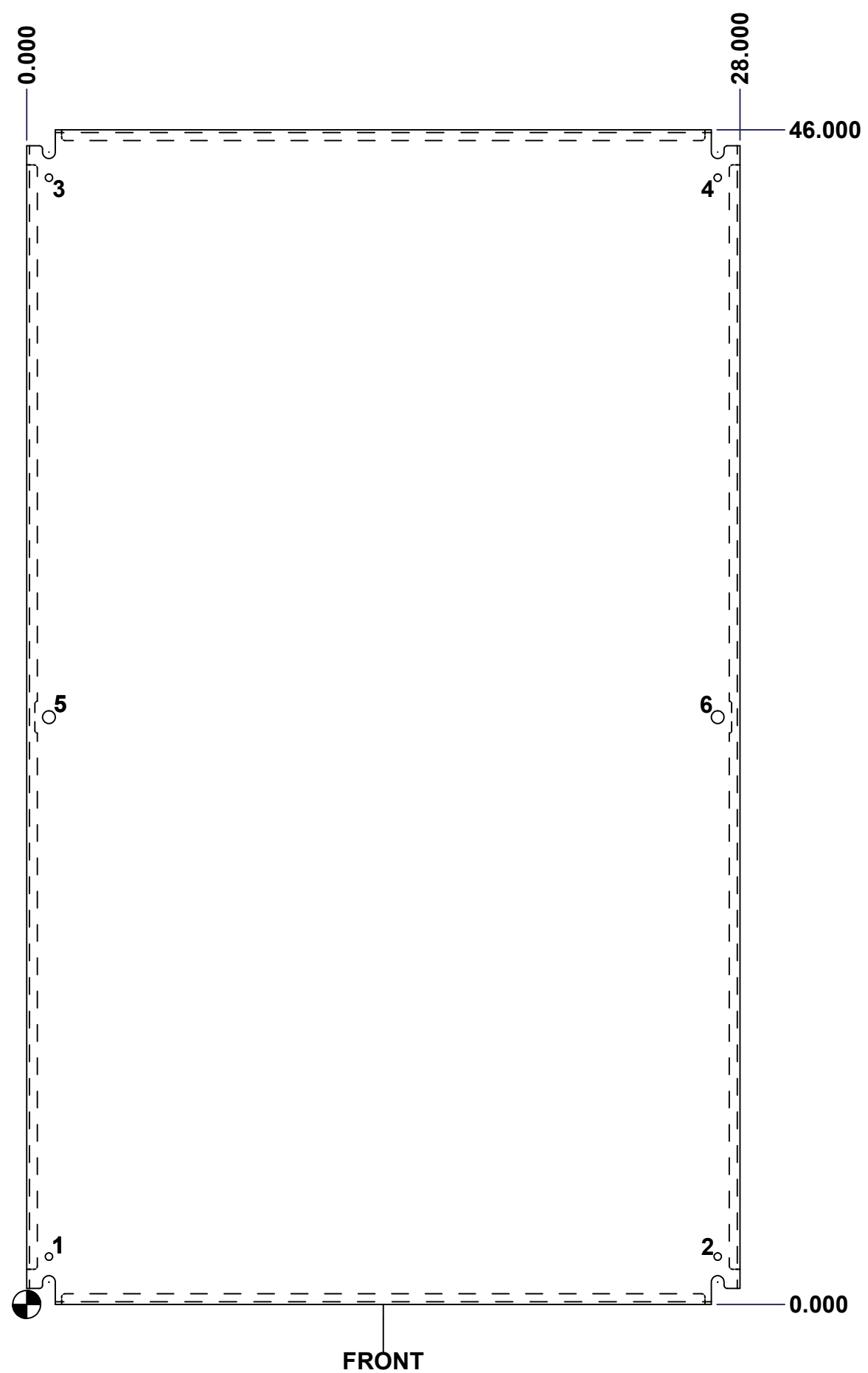

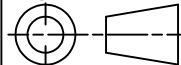
 Tél: (450) 979-4373 Fax: (450) 979-4626 www.exmweb.com		Flatness Aplatissement Max 3.0mm Projection 
Customer Client	Date	Date 1/23/2007
Drawn By Dessiné Par	BoxCad	
Material Matière	See Part List	
Color Couleur	See Part List	Finish Fini See Part List
Description	Detail Rev.	
881 SP - Inner Panel		
Part Number Numéro Pièce	Rev.	2
881 SP4830G		0