

This drawing is confidential and must not be reproduced or used without the consent of EXM

Ce dessin est confidentiel et ne doit pas être reproduit ou utilisé sans le consentement de EXM

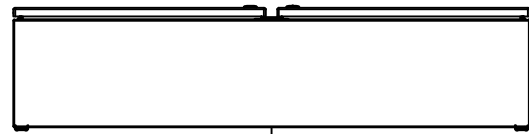

TOP

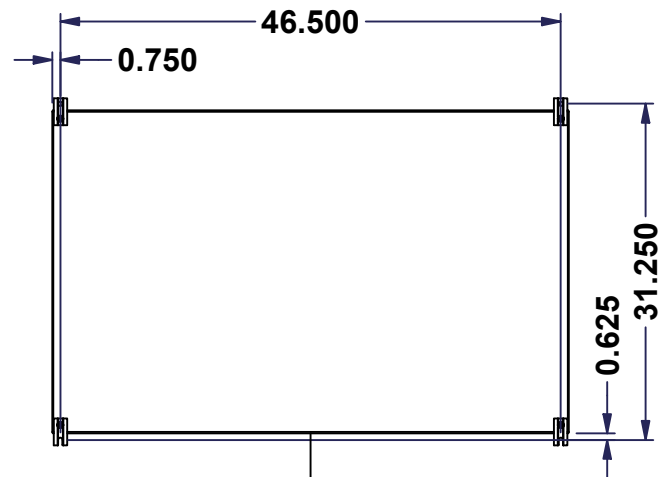

BACK

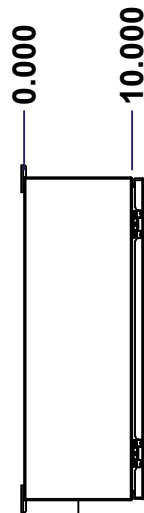

LEFT

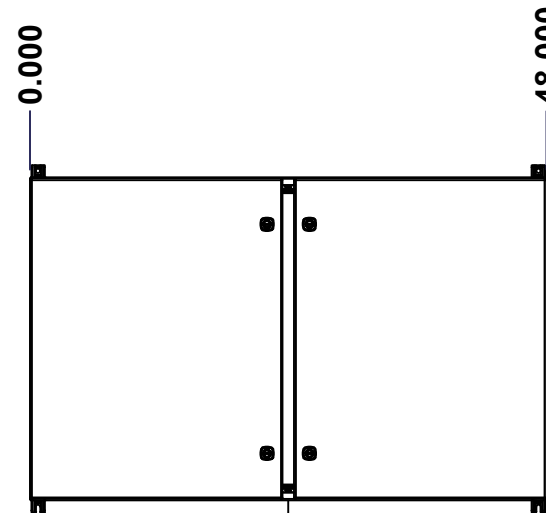

FRONT

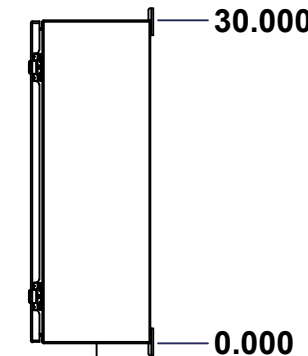

RIGHT



BOTTOM

No.	Revisions	Date	By/Par

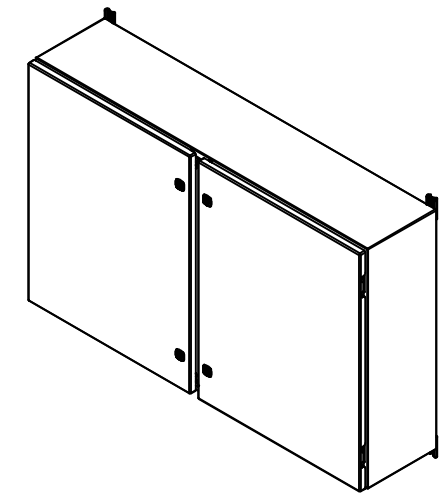

Isometric View



**GRAIN DIRECTION:  
TOP/BOTTOM: HORIZONTAL  
LEFT/RIGHT/BACK/FRONT: VERTICAL**

SEE BILL OF MATERIAL ON LAST PAGE

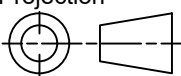
 Tél: (450) 979-4373 Fax: (450) 979-4626 <a href="http://www.exmweb.com">www.exmweb.com</a>		Flatness Aplatissement Max 3.0mm Projection 
Customer Client	Date	
Drawn By Dessiné Par	BoxCad: BoxCad	Date 17-Jan-25
Material Matière	14 Ga Stainless Steel 304 (1.7mm)	
Color Couleur	Unpainted	Finish Fini Brushed
Description	Detail Rev.	
5412ESSDD 30" x 48" x 10" Assembly		
Part Number Numéro Pièce	Rev. 0	1 / 20
5412ESSDD304810TH		

This drawing is confidential and must not be reproduced or used without the consent of EXM

Ce dessin est confidentiel et ne doit pas être reproduit ou utilisé sans le consentement de EXM

NOTE	
ITEM	DESCRIPTION
1	NEMA 4X Enclosure (IP66)
2	C/W Standard ground studs on box and cover
3	C/W Standard door stiffener
4	C/W Standard inner panel (Included)
5	C/W Standard inner panel mounting studs
6	C/W 885 ESMF4_OPEN Sold separately (Installed)
7	C/W 885 ESMF4_CLOSE Sold separately (Installed)
8	C/W R5 Insulation (Installed aluminum visible)

No.	Revisions	Date	By/Par

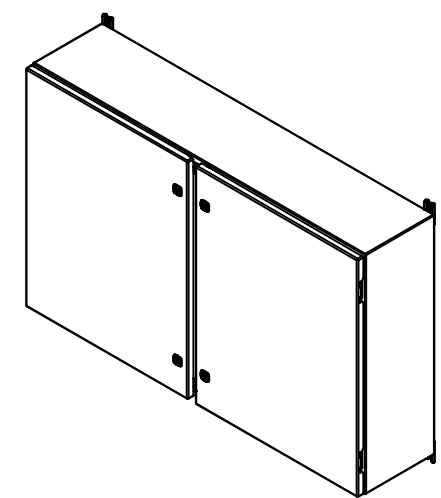

Isometric View



 Tél: (450) 979-4373  
 Fax: (450) 979-4626  
[www.exmweb.com](http://www.exmweb.com)

Flatness  
 Aplatissement  
 Max 3.0mm  
 Projection  

Customer Client	Date
Drawn By Dessiné Par BoxCad: BoxCad	Date 17-Jan-25

Material Matière 14 Ga Stainless Steel 304 (1.7mm)

Color Couleur	Unpainted	Finish Fini	Brushed
---------------	-----------	-------------	---------

Description 5412ESSDD 30" x 48" x 10" Assembly

Part Number Numéro Pièce	Rev.	2
<b>5412ESSDD304810TH</b>	<b>0</b>	20

6	STK-Q-00600	2	M12 to M8 Adaptor
1	881 SP4830G	0	881 SP - Inner Panel
1	STK-K-01800	5	5412 ES Accessory Kit
1	5412ESSDD304810THRD	0	5412ESSDD 30" x 48" Cover
1	5412ESSDD304810THLD	0	5412ESSDD 30" x 48" Cover
1	5412ESSDD304810THB	0	5412ESSDD 30" x 48" x 10" Body
4	STK-Q-04051-08	1	M6 x 8mm Stainless Steel Hexagon Socket Head Machine Screw with Nyseal
Qty	Part Number	Rev	Description
Parts List			

PACKING		
ITEM	QTY	DESCRIPTION
Cardboard sleeve	2	Top and Bottom
Cardboard strip	2	Between back of enclosure and inner panel
Plastic bag	1	To protect cover surface and inside gasket
Plastic strap - Black	2	To Squeeze the 2 cardboard sleeve together
Packaging label	1	White label with product number

This drawing is confidential and must not be reproduced or used without the consent of EXM

Ce dessin est confidentiel et ne doit pas être reproduit ou utilisé sans le consentement de EXM

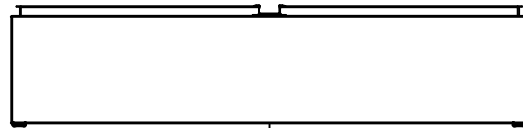

TOP



BACK

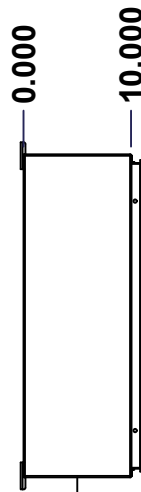

LEFT

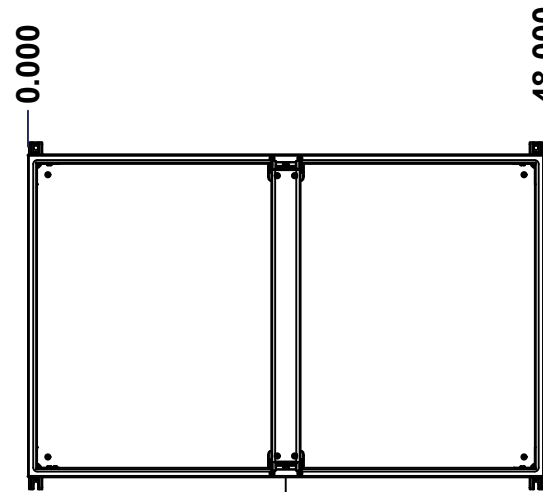

FRONT

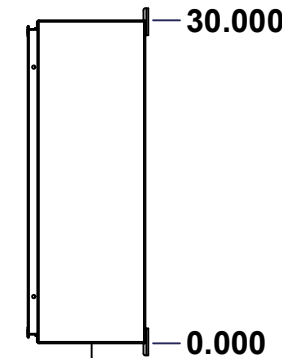

RIGHT

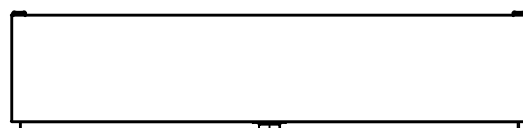

BOTTOM

No.	Revisions	Date	By/Par

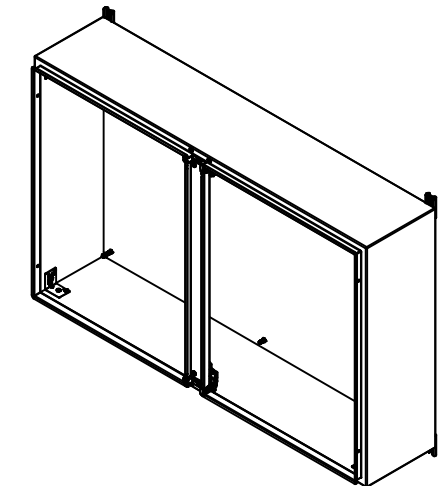

Isometric View



Tél: (450) 979-4373  
 Fax: (450) 979-4626  
[www.exmweb.com](http://www.exmweb.com)

Flatness  
Aplatissement

Max 3.0mm

Projection

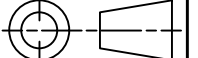

Customer Client	Date
Drawn By Dessiné Par BoxCad: BoxCad	Date 17-Jan-25
Material Matière 14 Ga Stainless Steel 304 (1.7mm)	
Color Couleur Unpainted	Finish Fini Brushed
Description 5412ESSDD 30" x 48" x 10" Body	Detail Rev.
Part Number Numéro Pièce <b>5412ESSDD304810THB</b>	Rev. <b>0</b>

SEE BILL OF MATERIAL ON LAST PAGE

This drawing is confidential and must not be reproduced or used without the consent of EXM

Ce dessin est confidentiel et ne doit pas être reproduit ou utilisé sans le consentement de EXM

<b>STANDARD FEATURES ARE NOT LISTED IN THIS HOLE TABLE</b>			
<b>HOLE TABLE - TOP VIEW (CUSTOM FEATURE ONLY)</b>			
CUT-OUT	XDIM	YDIM	DESCRIPTION
1	2.000	8.500	INSUL. STUD M6 x 18mm (Inside)
2	46.000	8.500	INSUL. STUD M6 x 18mm (Inside)

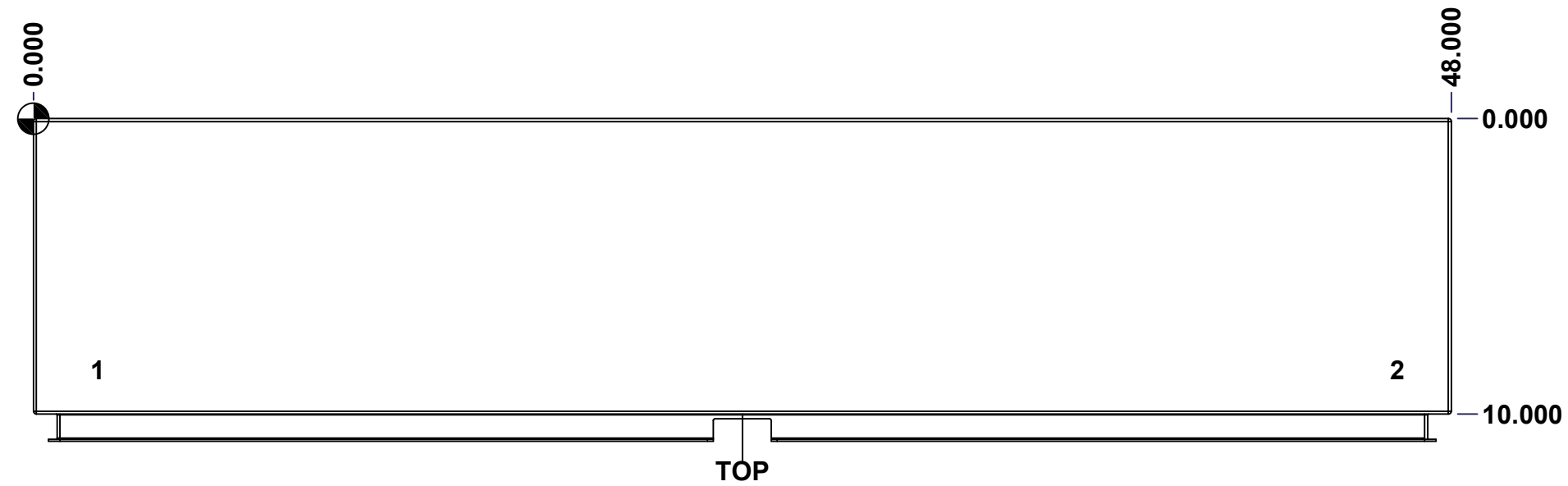

	Description	Status
	5412ESSDD 30" x 48" x 10" Body	(NULL)
Part Number Numéro Pièce	5412ESSDD304810THB	Rev. 4
		0 / 20

This drawing is confidential and must not be reproduced or used without the consent of EXM

Ce dessin est confidentiel et ne doit pas être reproduit ou utilisé sans le consentement de EXM

<b>STANDARD FEATURES ARE NOT LISTED IN THIS HOLE TABLE</b>			
<b>HOLE TABLE - BOTTOM VIEW (CUSTOM FEATURE ONLY)</b>			
CUT-OUT	XDIM	YDIM	DESCRIPTION
1	2.000	8.500	INSUL. STUD M6 x 18mm (Inside)
2	46.000	8.500	INSUL. STUD M6 x 18mm (Inside)

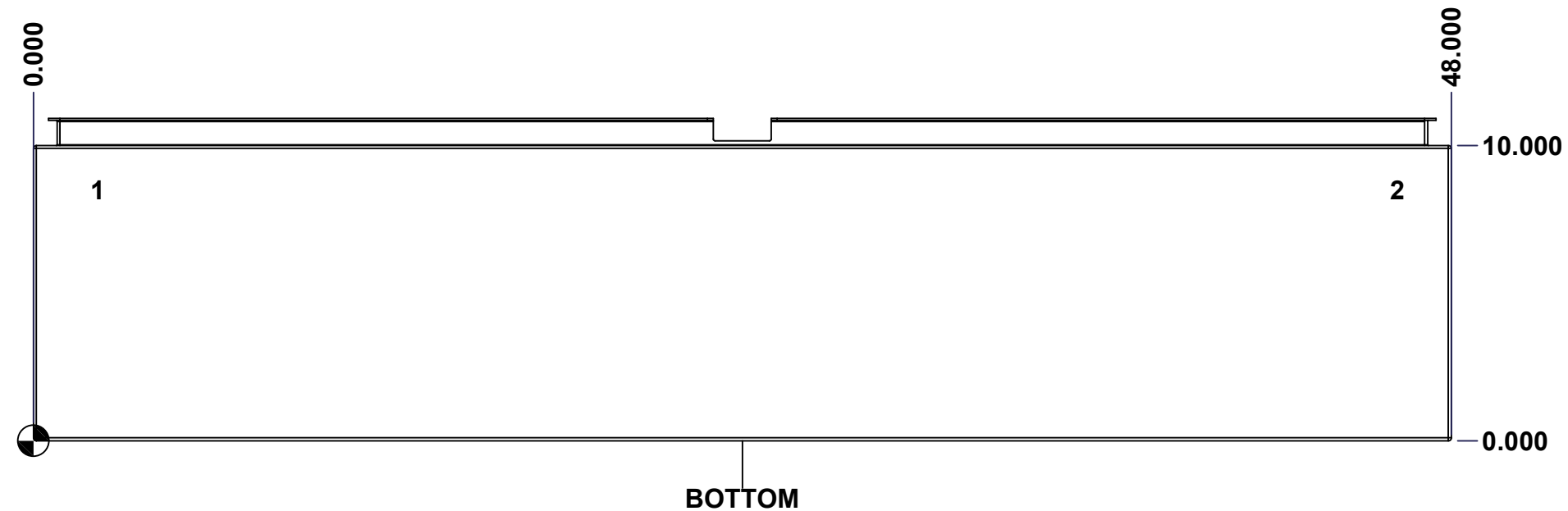

	Description	Status
	5412ESSDD 30" x 48" x 10" Body	(NULL)
	Part Number Numéro Pièce	Rev.
	<b>5412ESSDD304810THB</b>	<b>0</b>
		5
		20

This drawing is confidential and must not be reproduced or used without the consent of EXM

Ce dessin est confidentiel et ne doit pas être reproduit ou utilisé sans le consentement de EXM

**STANDARD FEATURES ARE NOT LISTED IN THIS HOLE TABLE**

**HOLE TABLE - BACK VIEW (CUSTOM FEATURE ONLY)**

CUT-OUT	XDIM	YDIM	DESCRIPTION
1	1.875	1.875	IP STUD M8 x 35mm (Inside)
2	1.875	28.125	IP STUD M8 x 35mm (Inside)
3	46.125	28.125	IP STUD M8 x 35mm (Inside)
4	46.125	1.875	IP STUD M8 x 35mm (Inside)
5	24.000	1.875	IP STUD M8 x 35mm (Inside)
6	24.000	28.125	IP STUD M8 x 35mm (Inside)
-----			
7	47.250	0.000	FOOT 885 ESMF4_OPEN
8	0.750	0.000	FOOT 885 ESMF4_OPEN
9	47.250	30.000	FOOT 885 ESMF4_CLOSE
10	0.750	30.000	FOOT 885 ESMF4_CLOSE

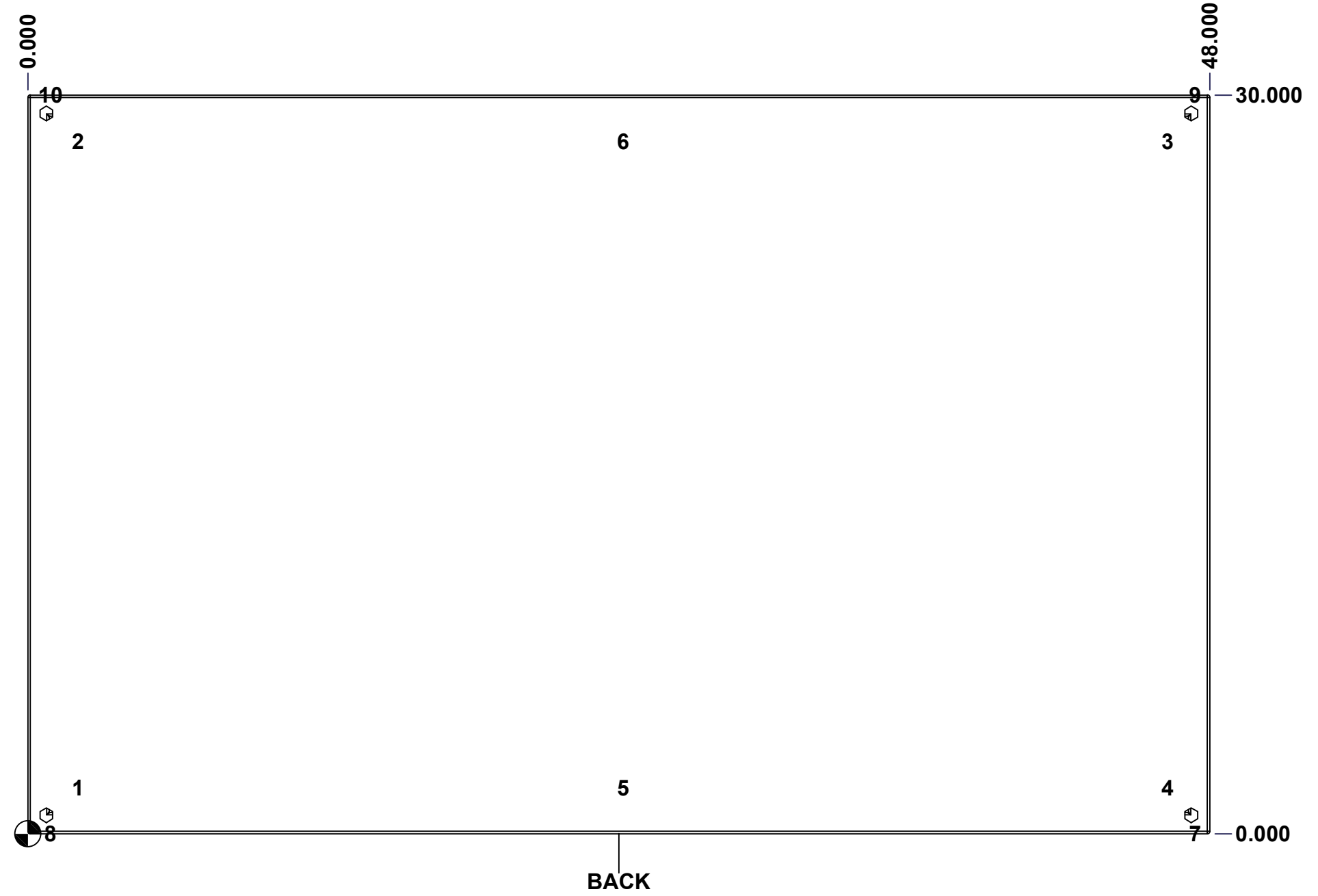

	Description	Status
	5412ESSDD 30" x 48" x 10" Body	(NULL)
	Part Number Numéro Pièce	Rev.
	<b>5412ESSDD304810THB</b>	<b>0</b> / 6
		20

This drawing is confidential and must not be reproduced or used without the consent of EXM

Ce dessin est confidentiel et ne doit pas être reproduit ou utilisé sans le consentement de EXM

No.	Revisions	Date	By/Par

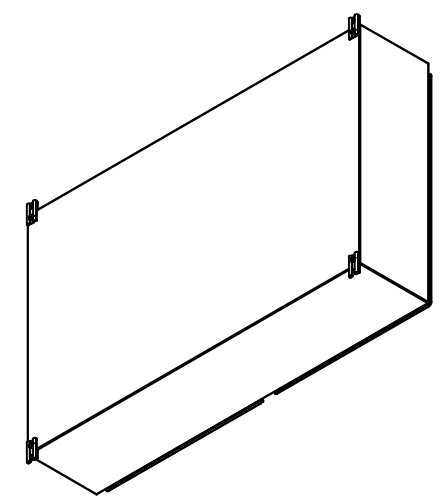

Isometric View



1	885 ESMF4	0	885 ESMF4 Mounting Foot Kit
4	RIVET_NUT_SS_M10_FH_CE	0	Stainless Steel Rivet Nut M10 (Low Profile Close End)
1	STK-K-70554	3	5412 ESTH Accessory Kit
1	5412ESSDD304810THI-RS	0	5412ESSDD 30" x 48" Right Insulation
1	5412ESSDD304810THI-LS	0	5412ESSDD 30" x 48" Left Insulation
1	5412ESSDD304810THI-BT	0	5412ESSDD 30" x 48"Bottom Insulation
1	5412ESSDD304810THI-TP	0	5412ESSDD 30" x 48"Top Insulation
1	5412ESSDD304810THI-B	0	5412ESSDD 30" x 48" Back Insulation
4	STK-Q-16070	1	Stud M6 x 18mm Stainless steel
6	STK-Q-16020	1	Stud M8 x 35mm Stainless Steel
1	STK-A-75455	2	Center Post - Stainless Steel Sealing Block with Latch Assembly (Small)
1	5412ESSDD304810THCP-P	0	5412ESSDD 30" Center Post Part
1	5412ESSDD304810THB-P	0	5412ESSDD 30" x 48" x 10" Body Part
Qty	Part Number	Rev	Description
Parts List			

Tél: (450) 979-4373 Fax: (450) 979-4626 <a href="http://www.exmweb.com">www.exmweb.com</a>	Flatness Aplatissement	Max 3.0mm
	Projection	
Customer Client	Date	
Drawn By Dessiné Par	BoxCad: BoxCad	Date 17-Jan-25
Material Matière	14 Ga Stainless Steel 304 (1.7mm)	
Color Couleur	Unpainted	Finish Fini Brushed
Description	Detail Rev.	
5412ESSDD 30" x 48" x 10" Body		
Part Number Numéro Pièce	Rev.	7
<b>5412ESSDD304810THB</b>	<b>0</b>	20

This drawing is confidential and must not be reproduced or used without the consent of EXM

Ce dessin est confidentiel et ne doit pas être reproduit ou utilisé sans le consentement de EXM

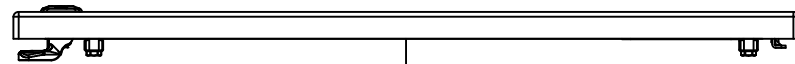

TOP

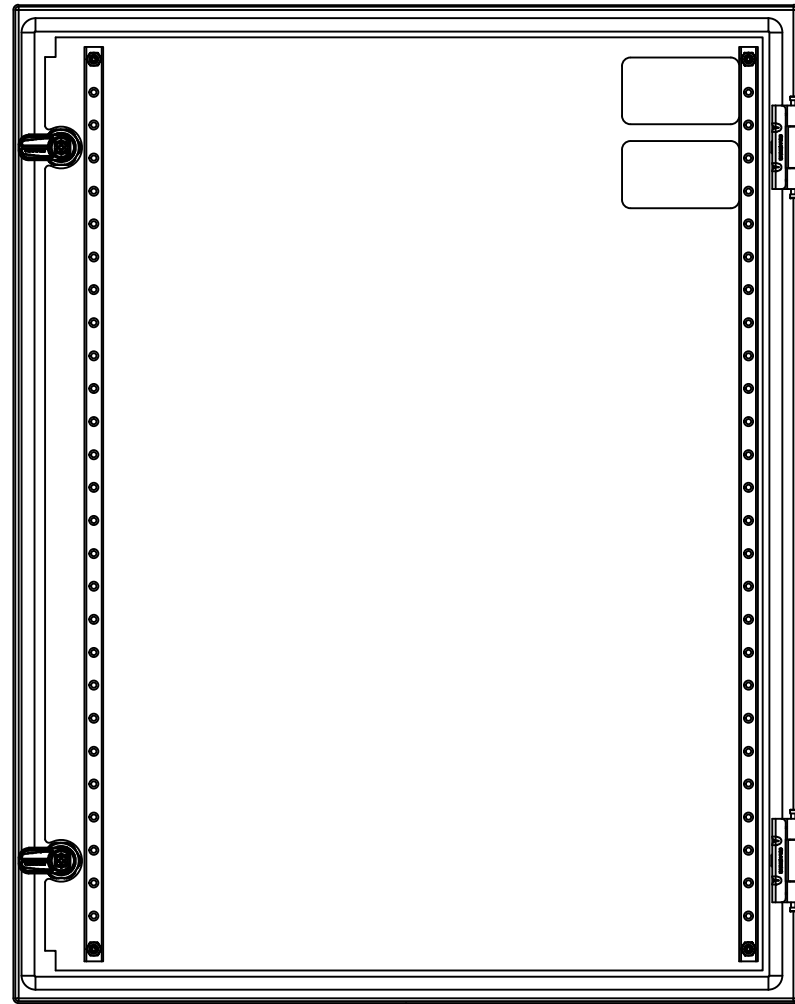

BACK

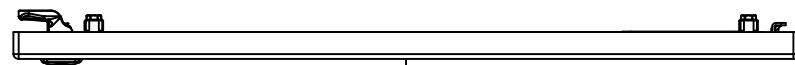

BOTTOM

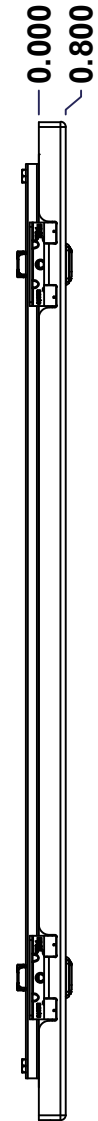

LEFT

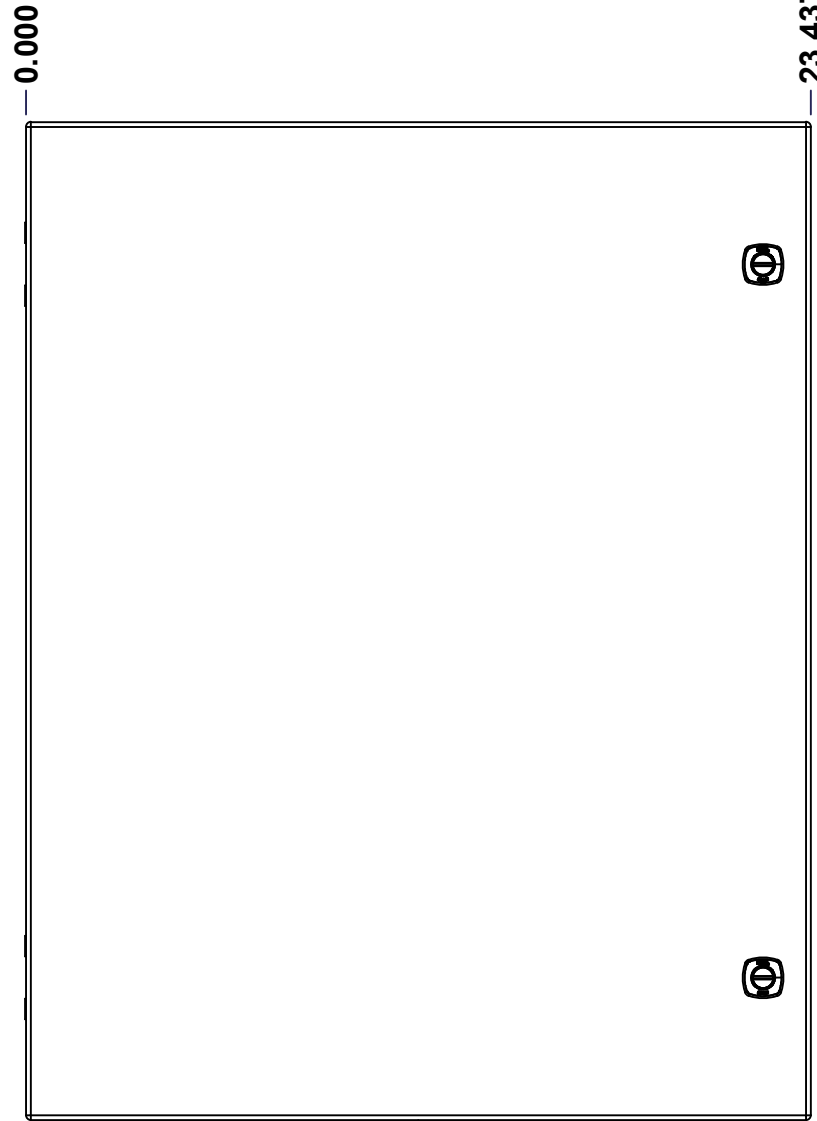

FRONT

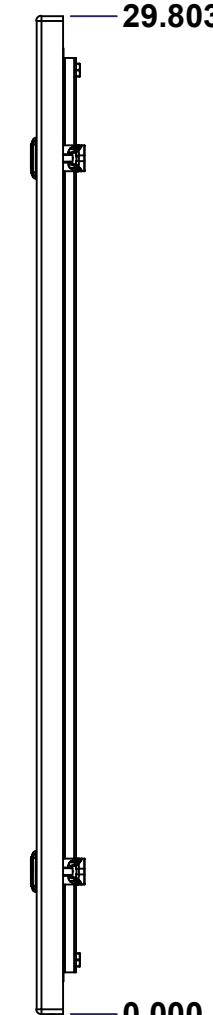

RIGHT

No.	Revisions	Date	By/Par

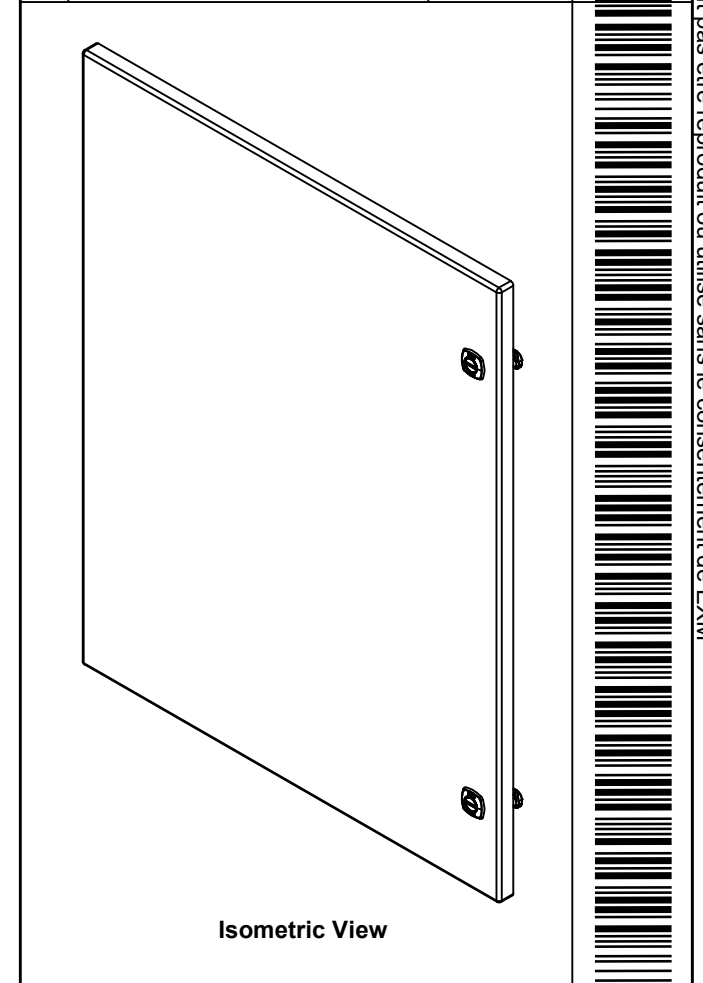

Isometric View

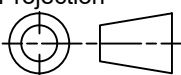

 Tél: (450) 979-4373 Fax: (450) 979-4626 <a href="http://www.exmweb.com">www.exmweb.com</a>		Flatness Aplatissement Max 3.0mm Projection 
Customer Client	Date	
Drawn By Dessiné Par	BoxCad: BoxCad	Date 17-Jan-25
Material Matière	16 Ga Stainless Steel 304 (1.4mm)	
Color Couleur	Unpainted	Finish Fini Brushed
Description 5412ESSDD 30" x 48" Cover		Detail Rev.
Part Number Numéro Pièce	Rev. 0	8 / 20

SEE BILL OF MATERIAL ON LAST PAGE **5412ESSDD304810THLD**

This drawing is confidential and must not be reproduced or used without the consent of EXM

Ce dessin est confidentiel et ne doit pas être reproduit ou utilisé sans le consentement de EXM

STANDARD FEATURES ARE NOT LISTED IN THIS HOLE TABLE			
HOLE TABLE - FRONT VIEW (CUSTOM FEATURE ONLY)			
CUT-OUT	XDIM	YDIM	DESCRIPTION
1	1.486	1.614	STUD M6 x 18mm (Inside)
2	1.486	28.189	STUD M6 x 18mm (Inside)
3	19.442	28.189	STUD M6 x 18mm (Inside)
4	19.442	1.614	STUD M6 x 18mm (Inside)
-----			
5	22.013	25.553	LOCK 880 SCQ4-SLSS6 @ 0.0°
6	22.013	4.250	LOCK 880 SCQ4-SLSS6 @ 0.0°

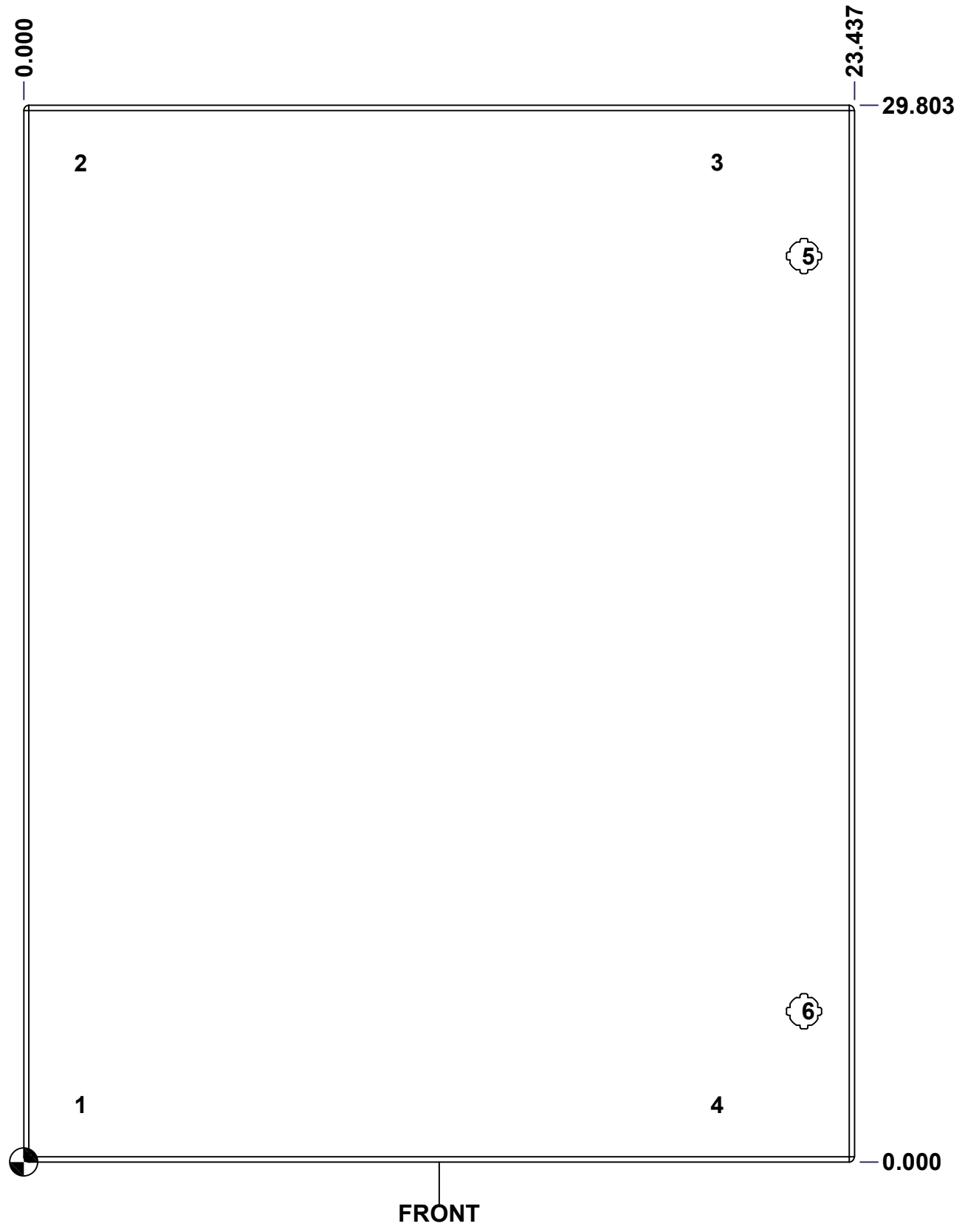

	Description	Status
	5412ESSDD 30" x 48" Cover	(NULL)
	Part Number Numéro Pièce	Rev.
	<b>5412ESSDD304810THLD</b>	<b>0</b> / 9
		20

This drawing is confidential and must not be reproduced or used without the consent of EXM

Ce dessin est confidentiel et ne doit pas être reproduit ou utilisé sans le consentement de EXM

No.	Revisions	Date	By/Par

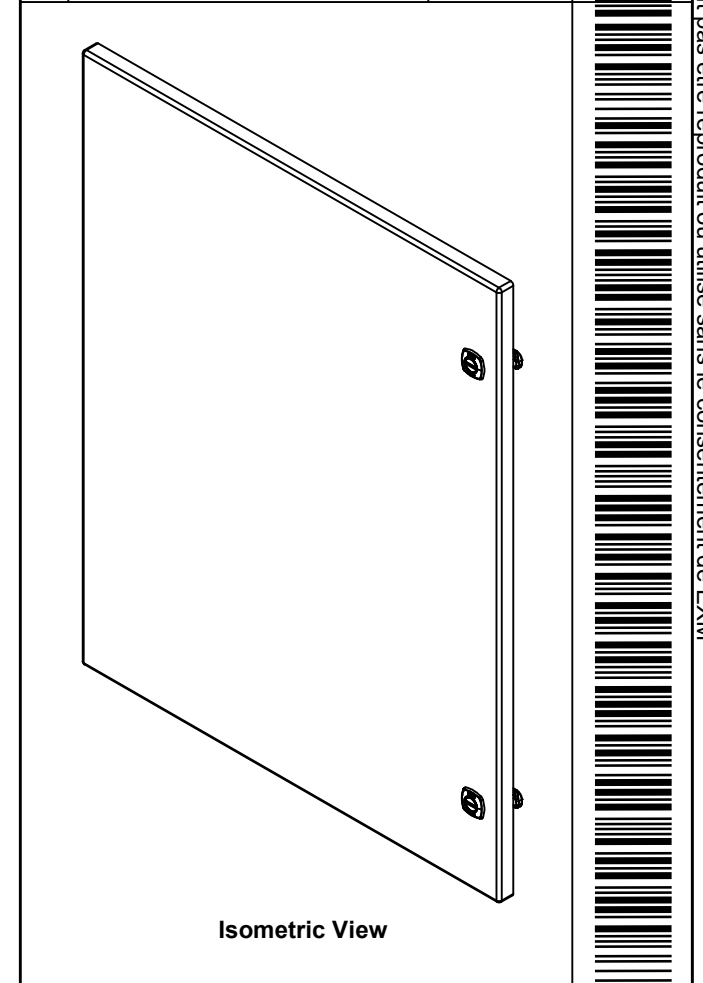

Isometric View

QTY	Part Number	Rev	Description
4	STK-Q-07250	2	M6 x 16mm Collar Nut
2	STK-Q-46020-30	6	5412 ES Vertical Door Stiffener 30"
2	STK-S-00100	0	3.5" x 2" Silver Milar Flexcon Sticker
1	5412ESSDD304810THI-LD	0	5412ESSDD 30" x 48" Left Door Insulation
2	STK-K-12590	7	5412 ESS 1/4 Turn Lock
4	STK-Q-16070	1	Stud M6 x 18mm Stainless steel
1	5412ESSDD304810THLD-G	0	5412ESSDD 30" x 23.437" Cover Gasket Part
1	5412ESSDD304810THLD-P	0	5412ESSDD 30" x 48" Cover Part
2	STK-A-33016	0	5412 ESS Bended Hinge (Body Part)
Parts List			

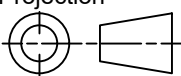
 Tél: (450) 979-4373 Fax: (450) 979-4626 <a href="http://www.exmweb.com">www.exmweb.com</a>		Flatness Aplatissement Max 3.0mm Projection 
Customer Client	Date	
Drawn By Dessiné Par	BoxCad: BoxCad	Date 17-Jan-25
Material Matière	16 Ga Stainless Steel 304 (1.4mm)	
Color Couleur	Unpainted	Finish Fini Brushed
Description 5412ESSDD 30" x 48" Cover		Detail Rev.
Part Number Numéro Pièce	Rev. 0	10 20

This drawing is confidential and must not be reproduced or used without the consent of EXM

Ce dessin est confidentiel et ne doit pas être reproduit ou utilisé sans le consentement de EXM



TOP

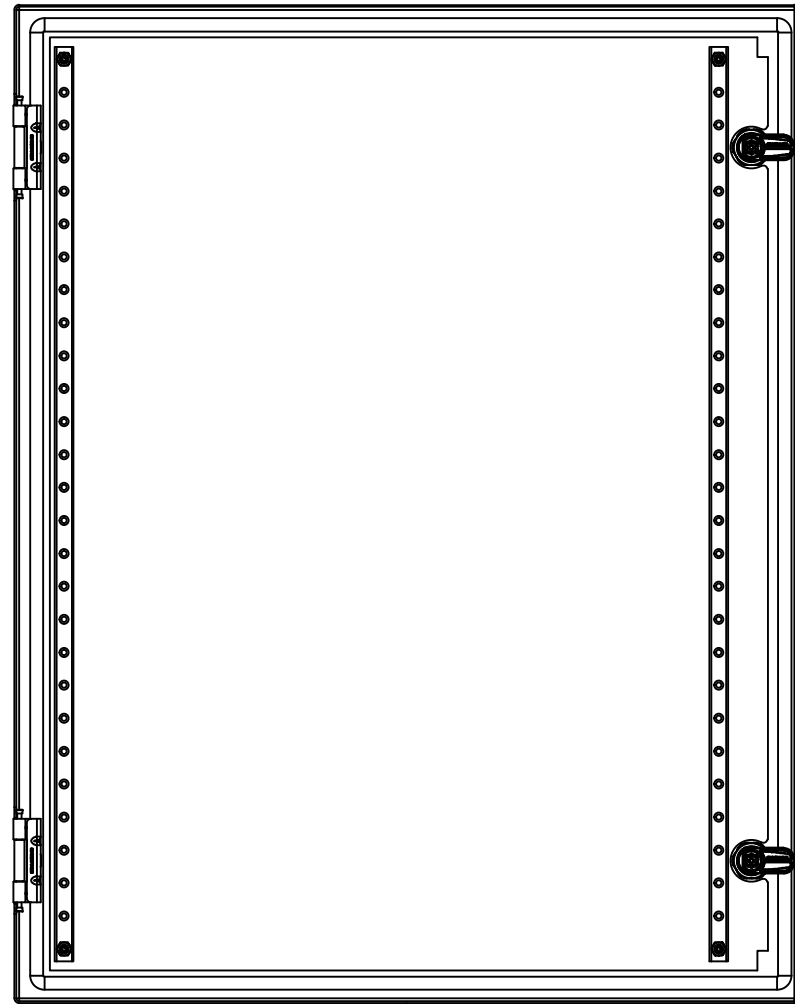

BACK

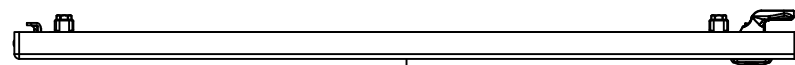

BOTTOM

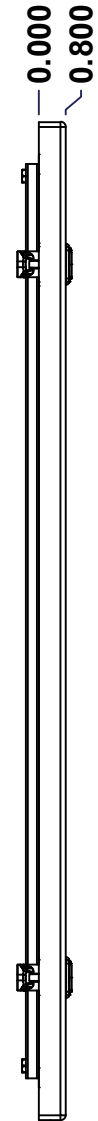

LEFT

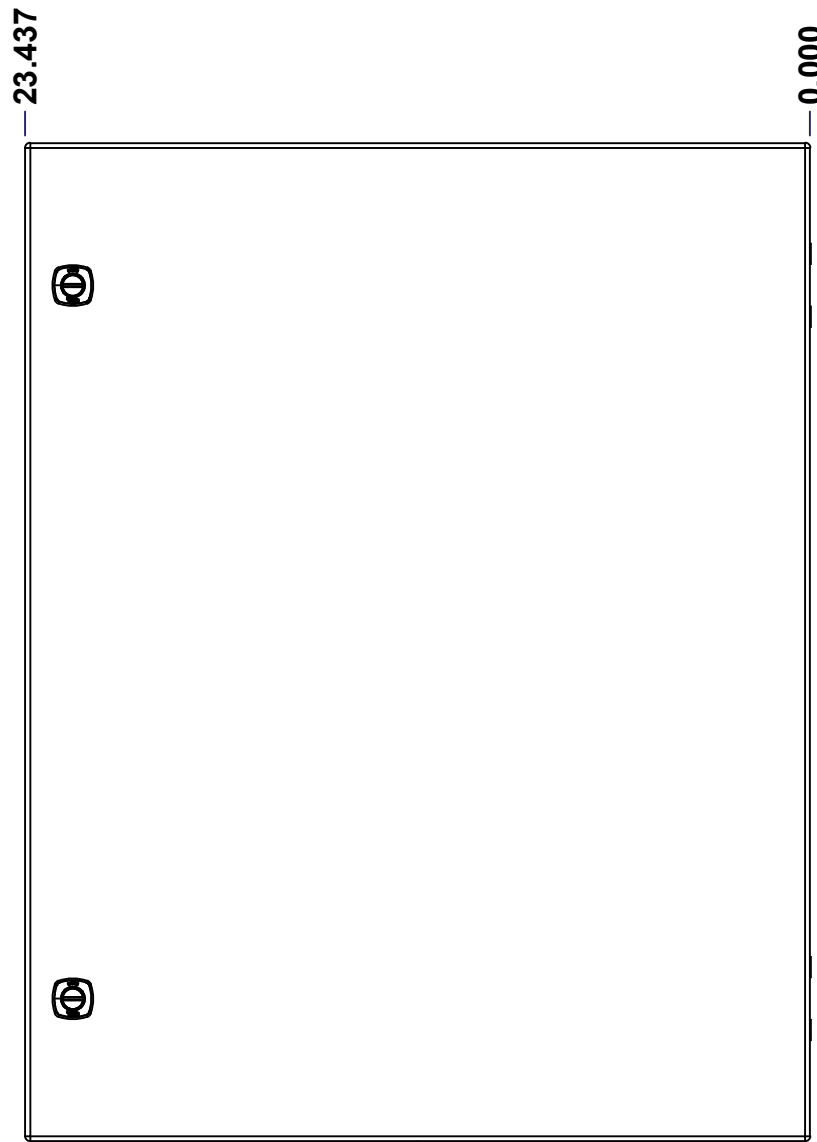

FRONT

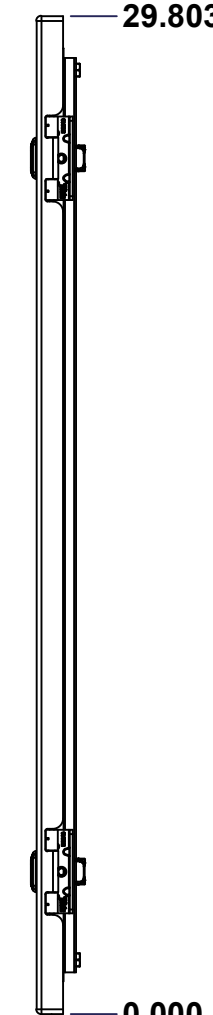

RIGHT

No.	Revisions	Date	By/Par

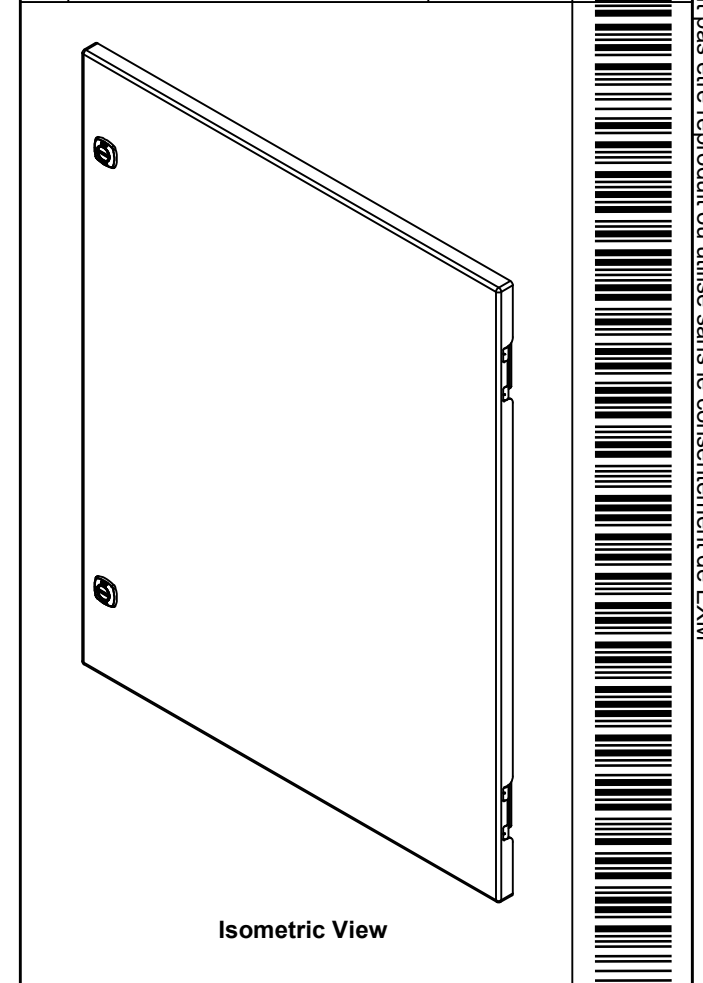

Isometric View



Tél: (450) 979-4373 Fax: (450) 979-4626 <a href="http://www.exmweb.com">www.exmweb.com</a>		Flatness Aplatissement Max 3.0mm Projection 
Customer Client	Date	
Drawn By Dessiné Par	BoxCad: BoxCad	Date 17-Jan-25
Material Matière	16 Ga Stainless Steel 304 (1.4mm)	
Color Couleur	Unpainted	Finish Fini Brushed
Description	Detail Rev.	
5412ESSDD 30" x 48" Cover		
Part Number Numéro Pièce	Rev. 0	11 / 20

SEE BILL OF MATERIAL ON LAST PAGE **5412ESSDD304810THRD**

This drawing is confidential and must not be reproduced or used without the consent of EXM

Ce dessin est confidentiel et ne doit pas être reproduit ou utilisé sans le consentement de EXM

**STANDARD FEATURES ARE NOT LISTED IN THIS HOLE TABLE**

**HOLE TABLE - FRONT VIEW (CUSTOM FEATURE ONLY)**

CUT-OUT	XDIM	YDIM	DESCRIPTION
1	1.486	1.614	STUD M6 x 18mm (Inside)
2	1.486	28.189	STUD M6 x 18mm (Inside)
3	19.442	28.189	STUD M6 x 18mm (Inside)
4	19.442	1.614	STUD M6 x 18mm (Inside)
-----			
5	22.013	25.553	LOCK 880 SCQ4-SLSS6 @ 180.0°
6	22.013	4.250	LOCK 880 SCQ4-SLSS6 @ 180.0°

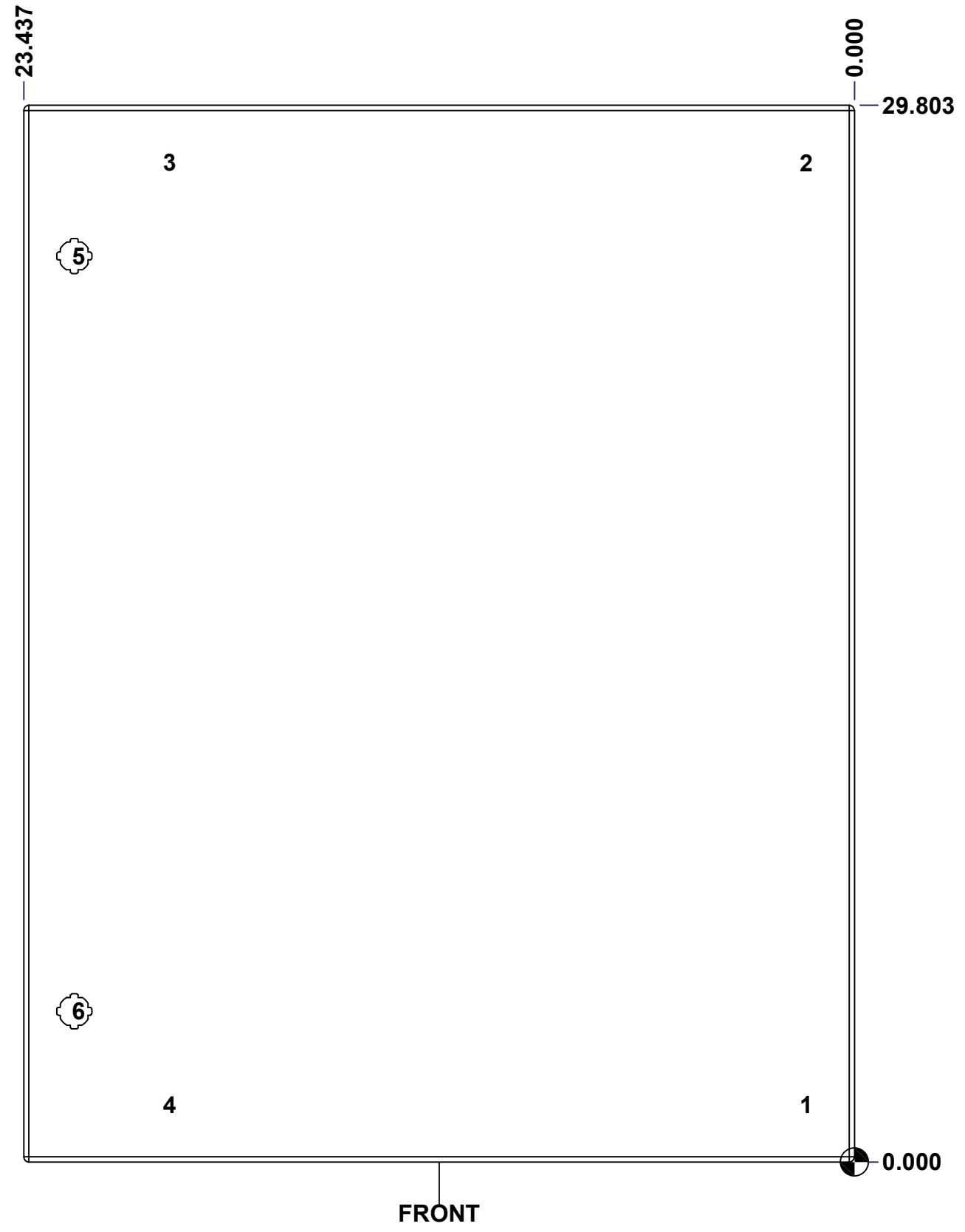

	Description	Status
	5412ESSDD 30" x 48" Cover	(NULL)
	Part Number Numéro Pièce	Rev.
	<b>5412ESSDD304810THRD</b>	<b>0</b>
		12 20

This drawing is confidential and must not be reproduced or used without the consent of EXM

Ce dessin est confidentiel et ne doit pas être reproduit ou utilisé sans le consentement de EXM

No.	Revisions	Date	By/Par

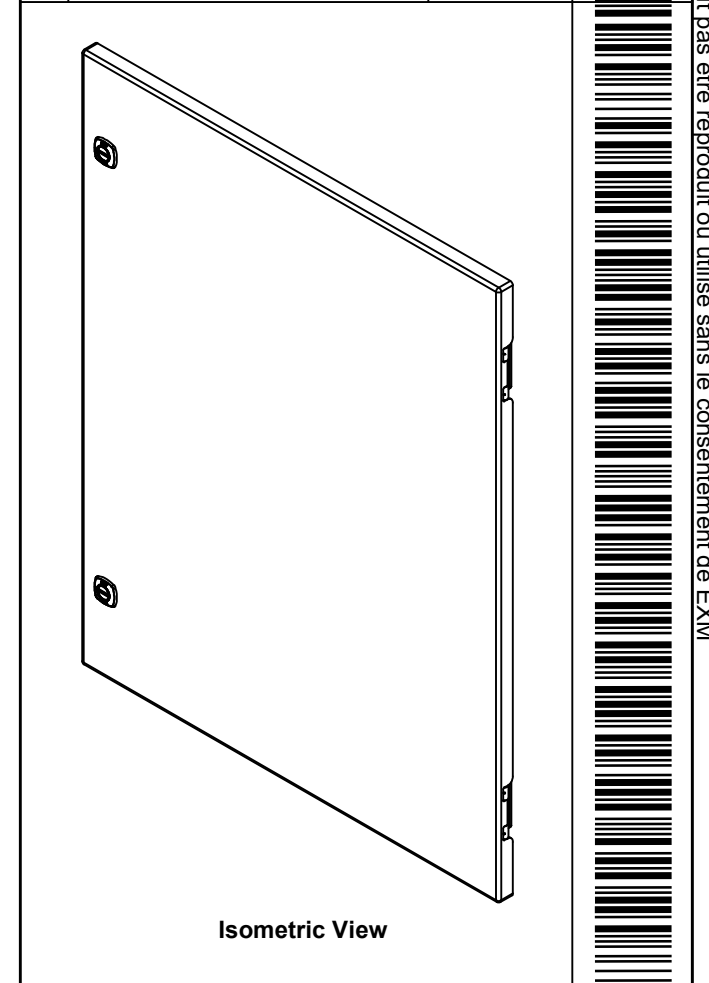

 Tél: (450) 979-4373  
 Fax: (450) 979-4626  
[www.exmweb.com](http://www.exmweb.com)

Flatness / Aplatissement: Max 3.0mm  
 Projection: 

4	STK-Q-07250	2	M6 x 16mm Collar Nut
2	STK-Q-46020-30	6	5412 ES Vertical Door Stiffener 30"
1	5412ESSDD304810THI-R D	0	5412ESSDD 30" x 48" Right Door Insulation
2	STK-K-12590	7	5412 ESS 1/4 Turn Lock
4	STK-Q-16070	1	Stud M6 x 18mm Stainless steel
1	5412ESSDD304810THRD -G	0	5412ESSDD 30" x 23.437" Cover Gasket Part
1	5412ESSDD304810THRD -P	0	5412ESSDD 30" x 48" Cover Part
2	STK-A-33016	0	5412 ESS Bended Hinge (Body Part)
QTY	Part Number	Rev	Description
Parts List			

Customer Client	Date
Drawn By / Dessiné Par: BoxCad: BoxCad	Date: 17-Jan-25
Material / Matière: 16 Ga Stainless Steel 304 (1.4mm)	
Color / Couleur: Unpainted	Finish / Fini: Brushed
Description: 5412ESSDD 30" x 48" Cover	Detail Rev.
Part Number / Numéro Pièce: <b>5412ESSDD304810THRD</b>	Rev. <b>0</b>
	13 / 20

This drawing is confidential and must not be reproduced or used without the consent of EXM

Ce dessin est confidentiel et ne doit pas être reproduit ou utilisé sans le consentement de EXM

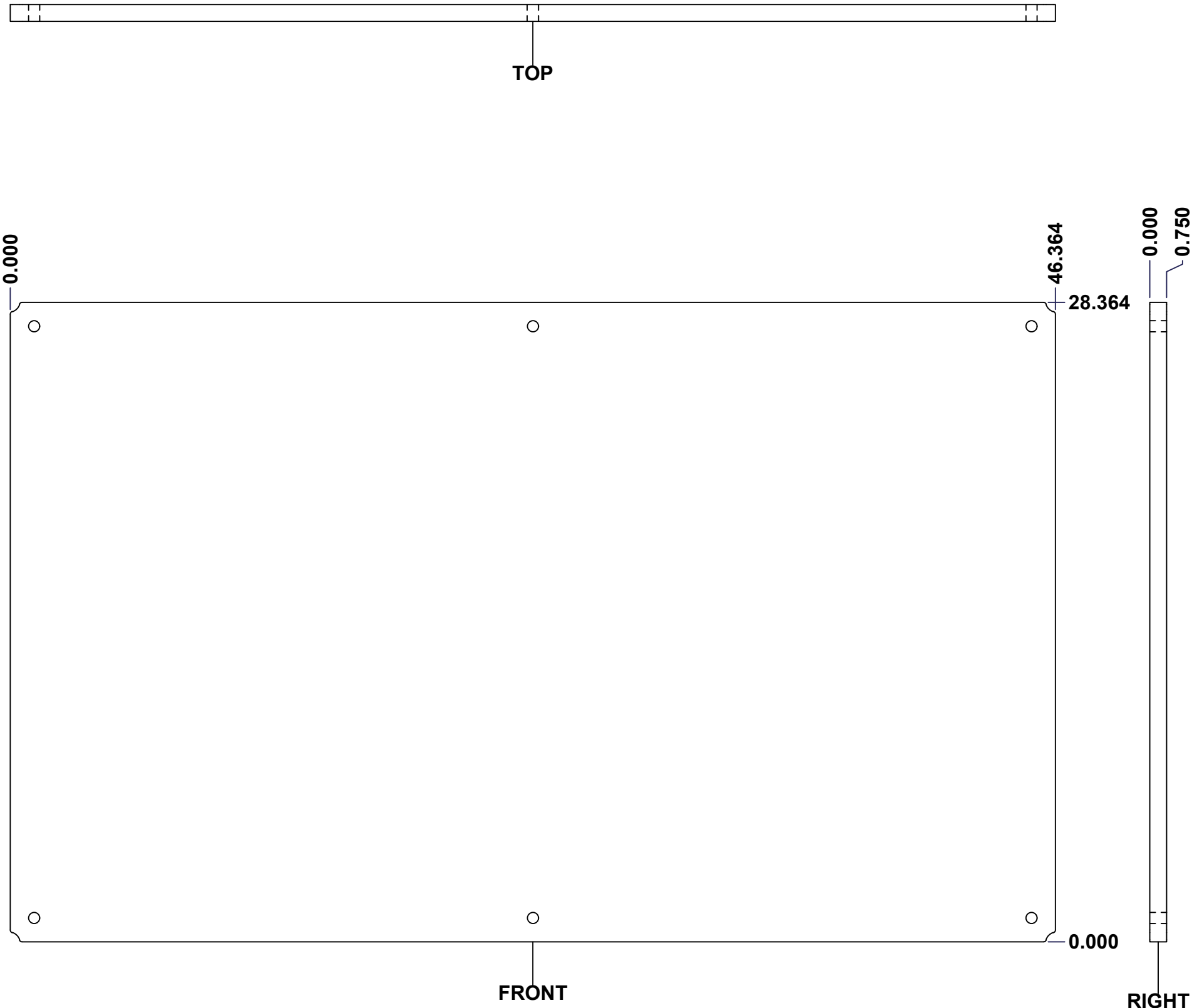

No.	Revisions	Date	By/Par

**Isometric View**

<p>Tél: (450) 979-4373                  Fax: (450) 979-4626  <a href="http://www.exmweb.com">www.exmweb.com</a></p>		Flatness Aplatissement
		Max 3.0mm
Customer Client		Date
Drawn By Dessiné Par		Date
Material Matière		Projection
Polyisocyanurate		
Color Couleur	Aluminum	Finish Fini
Description		Detail Rev.
5412ESSDD 30" x 48" Back Insulation		
Part Number Numéro Pièce	Rev.	
5412ESSDD304810THI-B	0	14 20

**SEE BILL OF MATERIAL ON LAST PAGE**

This drawing is confidential and must not be reproduced or used without the consent of EXM

Ce dessin est confidentiel et ne doit pas être reproduit ou utilisé sans le consentement de EXM

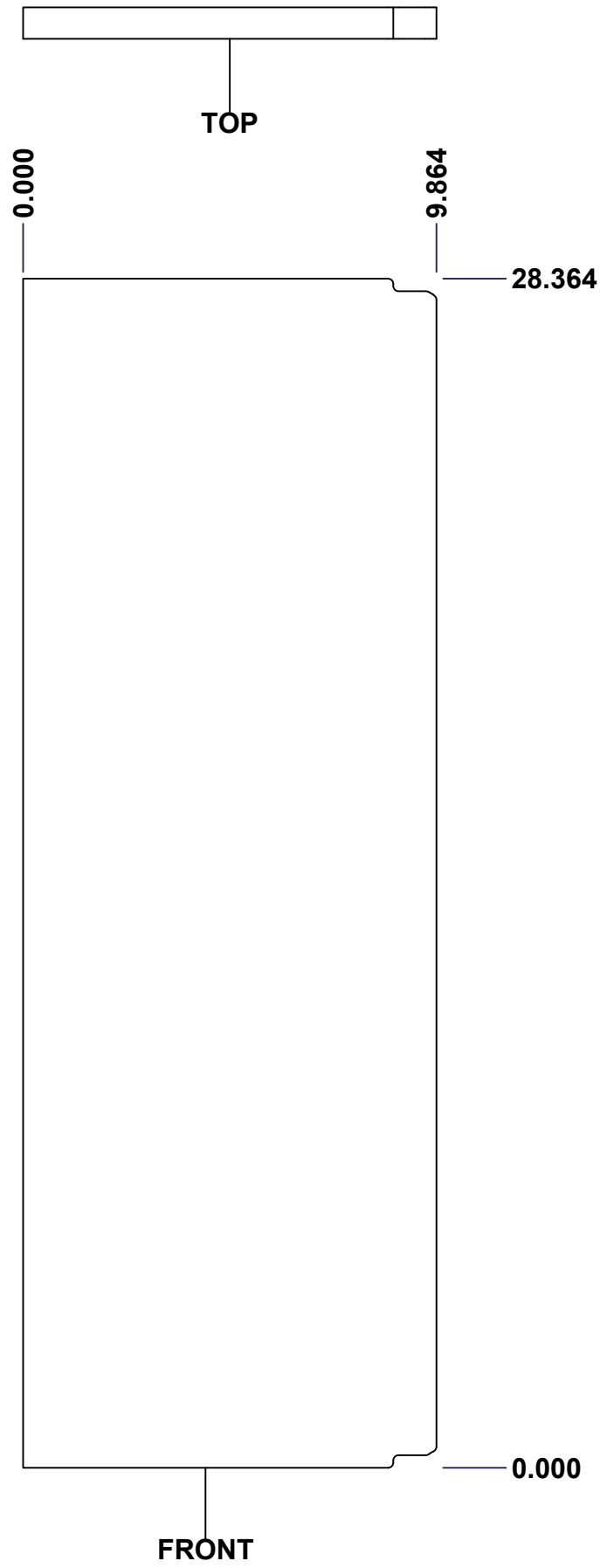

No.	Revisions	Date	By/Par

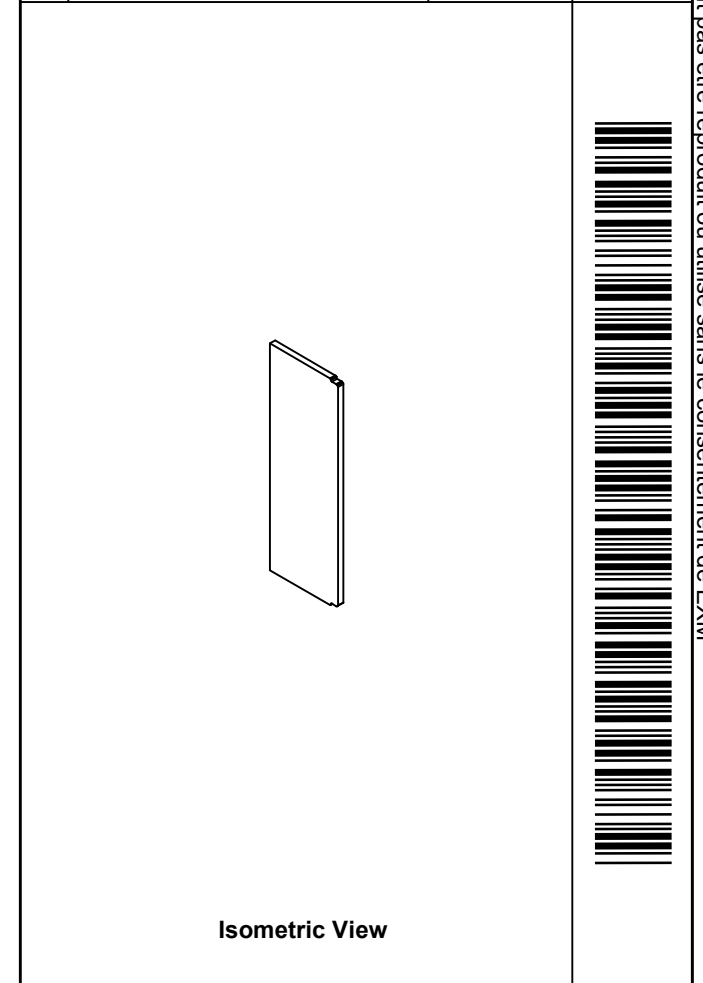

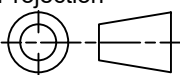
 Tél: (450) 979-4373 Fax: (450) 979-4626 <a href="http://www.exmweb.com">www.exmweb.com</a>		Flatness Aplatissement Max 3.0mm
Projection 		Date 23-Jan-07
Customer Client	Date	
Drawn By / Dessiné Par: BoxCad: Patrick Deschenes	Date: 23-Jan-07	
Material / Matière: Polyisocyanurate		
Color / Couleur: Aluminum	Finish / Fini: N/A	
Description: 5412ESSDD 30" x 48" Left Insulation	Detail Rev.	
Part Number / Numéro Pièce: 5412ESSDD304810TH-LS	Rev. 0	15 / 20

SEE BILL OF MATERIAL ON LAST PAGE

This drawing is confidential and must not be reproduced or used without the consent of EXM

Ce dessin est confidentiel et ne doit pas être reproduit ou utilisé sans le consentement de EXM

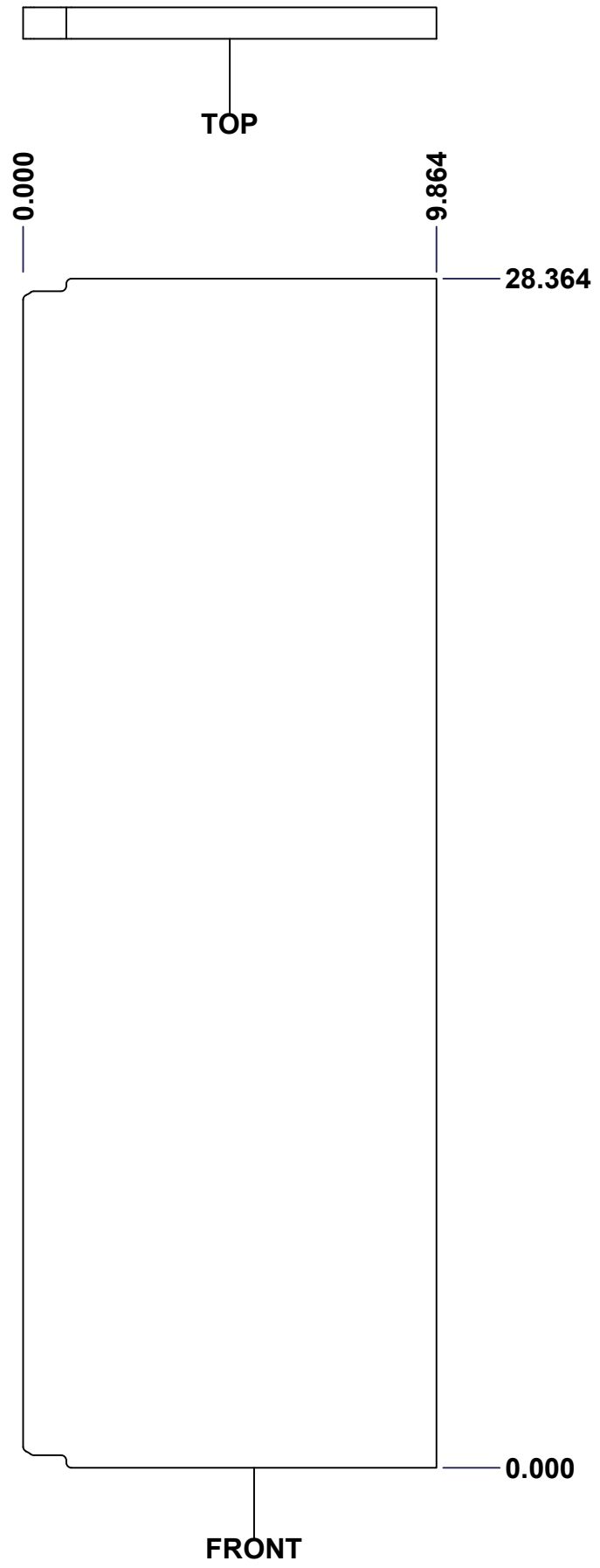

No.	Revisions	Date	By/Par

**Isometric View**

Tél: (450) 979-4373 Fax: (450) 979-4626 <a href="http://www.exmweb.com">www.exmweb.com</a>		Flatness Aplatissement	Max 3.0mm
		Projection	
Customer Client	Date	Date 23-Jan-07	
Drawn By Dessiné Par	BoxCad: Patrick Deschenes	Date 23-Jan-07	
Material Matière	Polyisocyanurate		
Color Couleur	Aluminum	Finish Fini	N/A
Description		Detail Rev.	
5412ESSDD 30" x 48" Right Insulation			
Part Number Numéro Pièce	Rev.	16	20
<b>5412ESSDD304810THI-RS</b>	<b>0</b>		

**SEE BILL OF MATERIAL ON LAST PAGE**

This drawing is confidential and must not be reproduced or used without the consent of EXM

Ce dessin est confidentiel et ne doit pas être reproduit ou utilisé sans le consentement de EXM

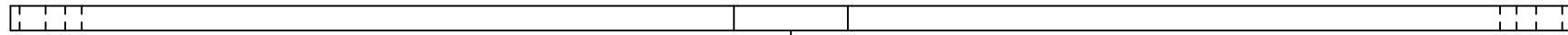

TOP

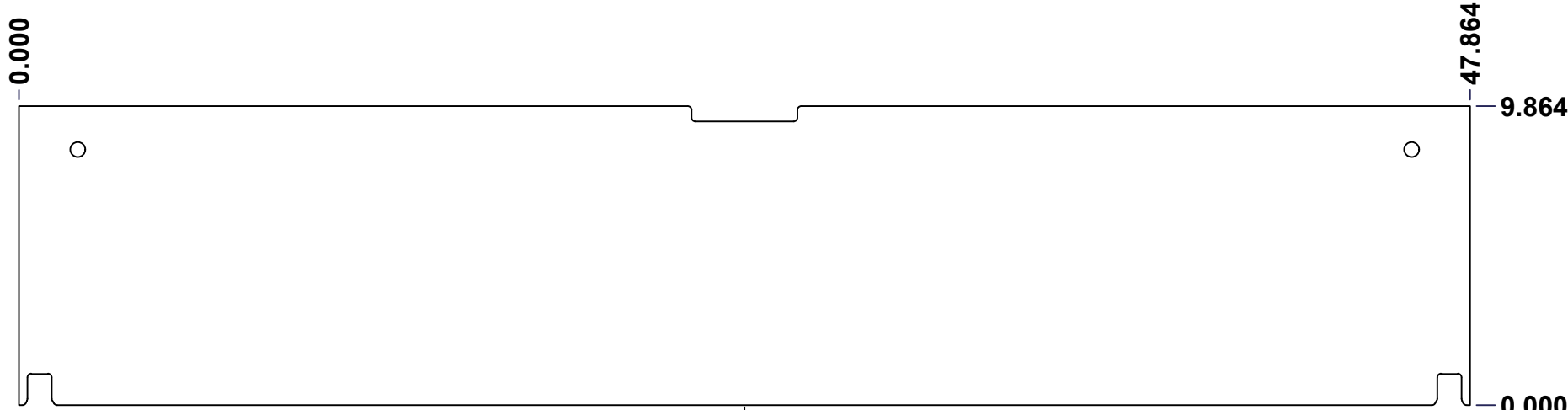

FRONT

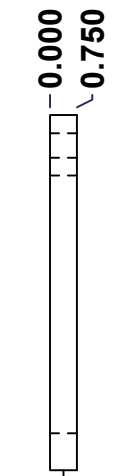

RIGHT

No.	Revisions	Date	By/Par

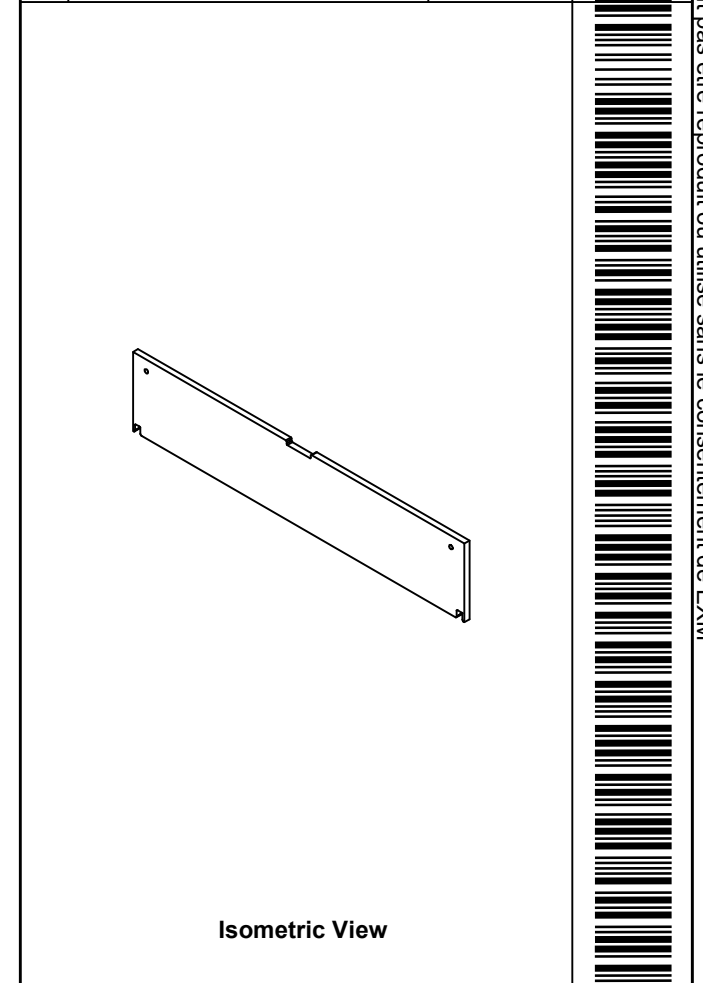

<p>Tél: (450) 979-4373 Fax: (450) 979-4626 <a href="http://www.exmweb.com">www.exmweb.com</a></p>	Flatness Aplatissement Max 3.0mm
	Projection 
Customer Client	Date
Drawn By Dessiné Par BoxCad: BoxCad	Date 4/3/2024
Material Matière Polyisocyanurate	
Color Couleur Aluminum	Finish Fini Brushed
Description 5412ESSDD 30" x 48"Top Insulation	Detail Rev.
Part Number Numéro Pièce <b>5412ESSDD304810THI-TP</b>	Rev. <b>0</b>

SEE BILL OF MATERIAL ON LAST PAGE

17  
20

This drawing is confidential and must not be reproduced or used without the consent of EXM

Ce dessin est confidentiel et ne doit pas être reproduit ou utilisé sans le consentement de EXM

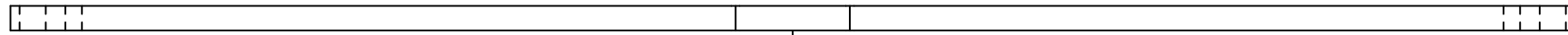

TOP

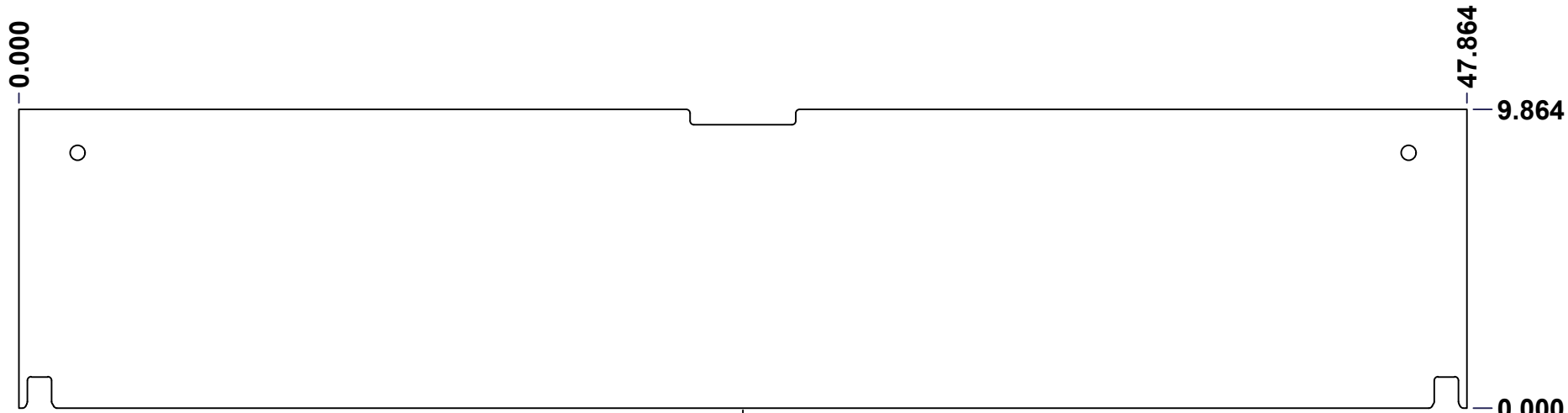

FRONT

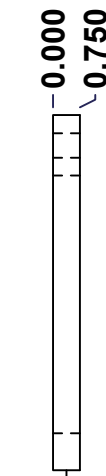

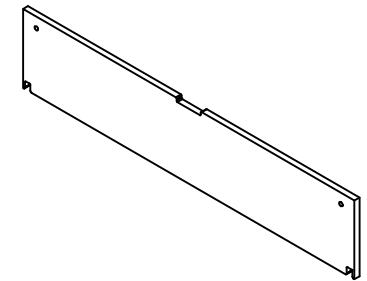

RIGHT



Isometric View

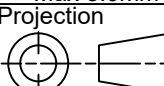

No.	Revisions	Date	By/Par

 Tél: (450) 979-4373 Fax: (450) 979-4626 <a href="http://www.exmweb.com">www.exmweb.com</a>	Flatness Aplatissement  Max 3.0mm
	Projection 
Customer Client	Date
Drawn By Dessiné Par BoxCad: BoxCad	Date 4/3/2024
Material Matière Polyisocyanurate	
Color Couleur Aluminum	Finish Fini Brushed
Description 5412ESSDD 30" x 48"Bottom Insulation	
Detail Rev.	
Part Number Numéro Pièce 5412ESSDD304810THI-BT	Rev. 18 0 20

SEE BILL OF MATERIAL ON LAST PAGE

This drawing is confidential and must not be reproduced or used without the consent of EXM

Ce dessin est confidentiel et ne doit pas être reproduit ou utilisé sans le consentement de EXM

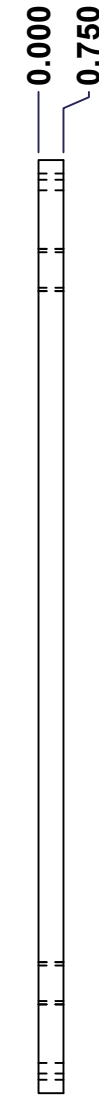
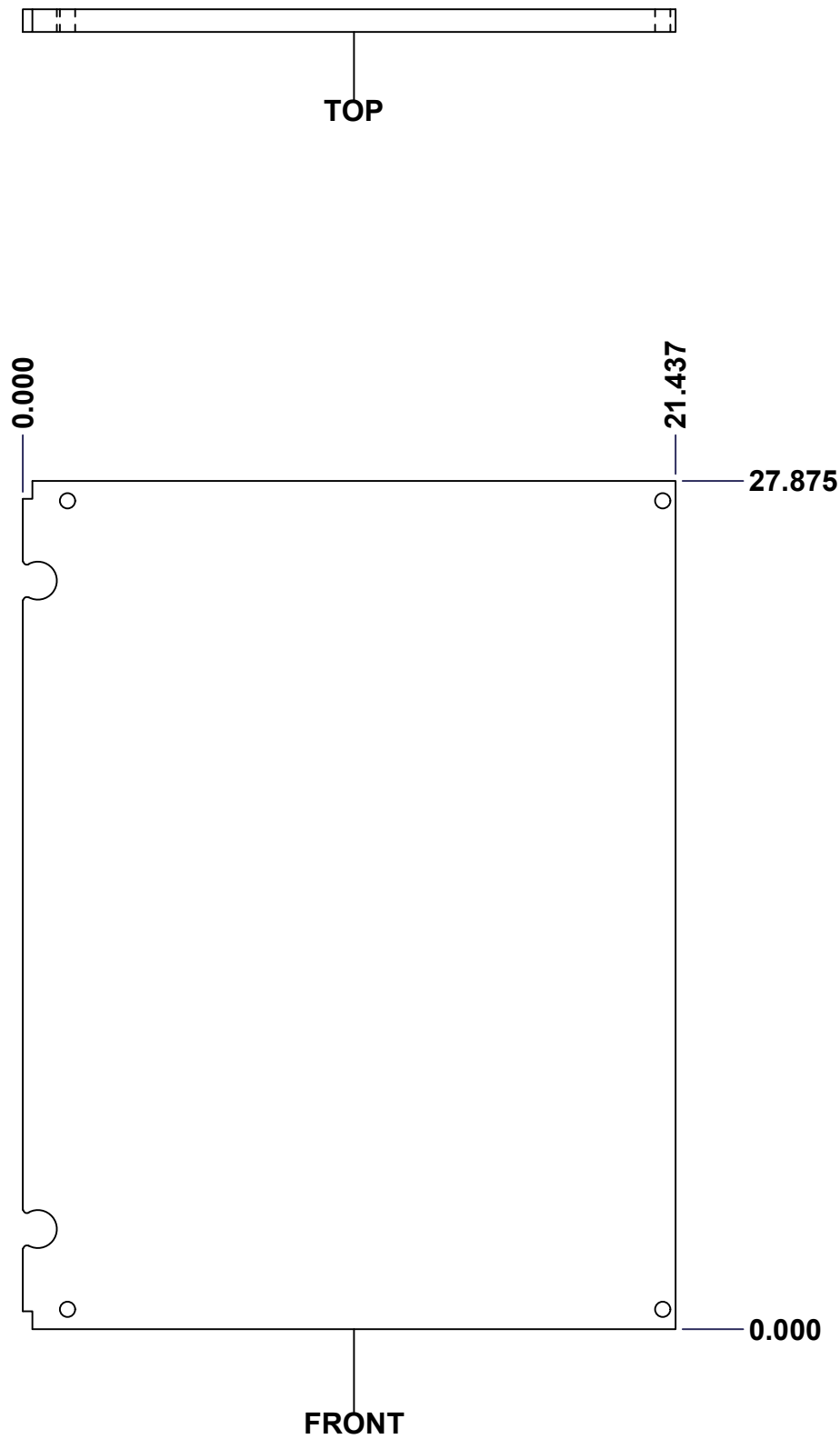

No.	Revisions	Date	By/Par

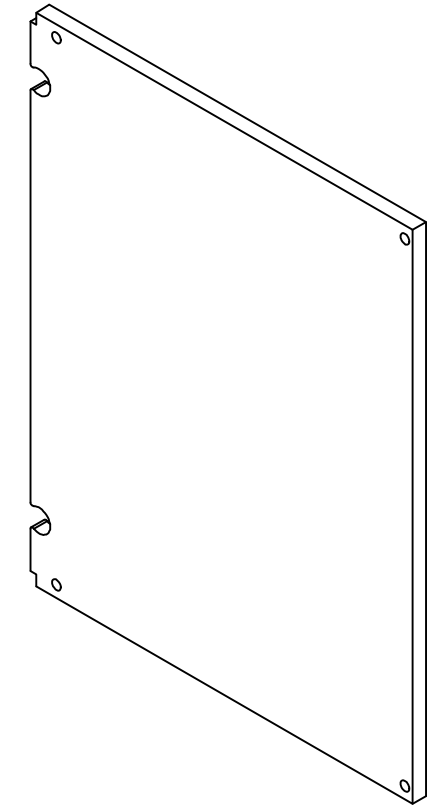

Isometric View



Tél: (450) 979-4373  
 Fax: (450) 979-4626  
[www.exmweb.com](http://www.exmweb.com)

Flatness  
Aplatissement

Max 3.0mm

Projection

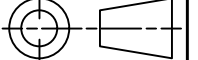

Customer Client	Date
Drawn By Dessiné Par	Date 23-Jan-07
Material Matière	Polyisocyanurate
Color Couleur	Aluminum
Finish Fini	N/A
Description	Detail Rev.
5412ESSDD 30" x 48" Left Door Insulation	
Part Number Numéro Pièce	Rev. 19
<b>5412ESSDD304810TH-LD</b>	<b>0</b> 20

SEE BILL OF MATERIAL ON LAST PAGE

This drawing is confidential and must not be reproduced or used without the consent of EXM

Ce dessin est confidentiel et ne doit pas être reproduit ou utilisé sans le consentement de EXM

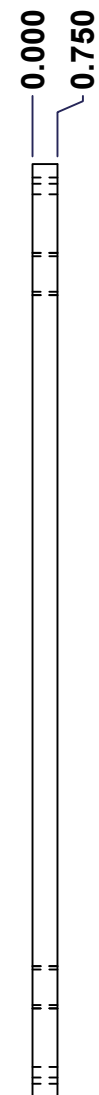
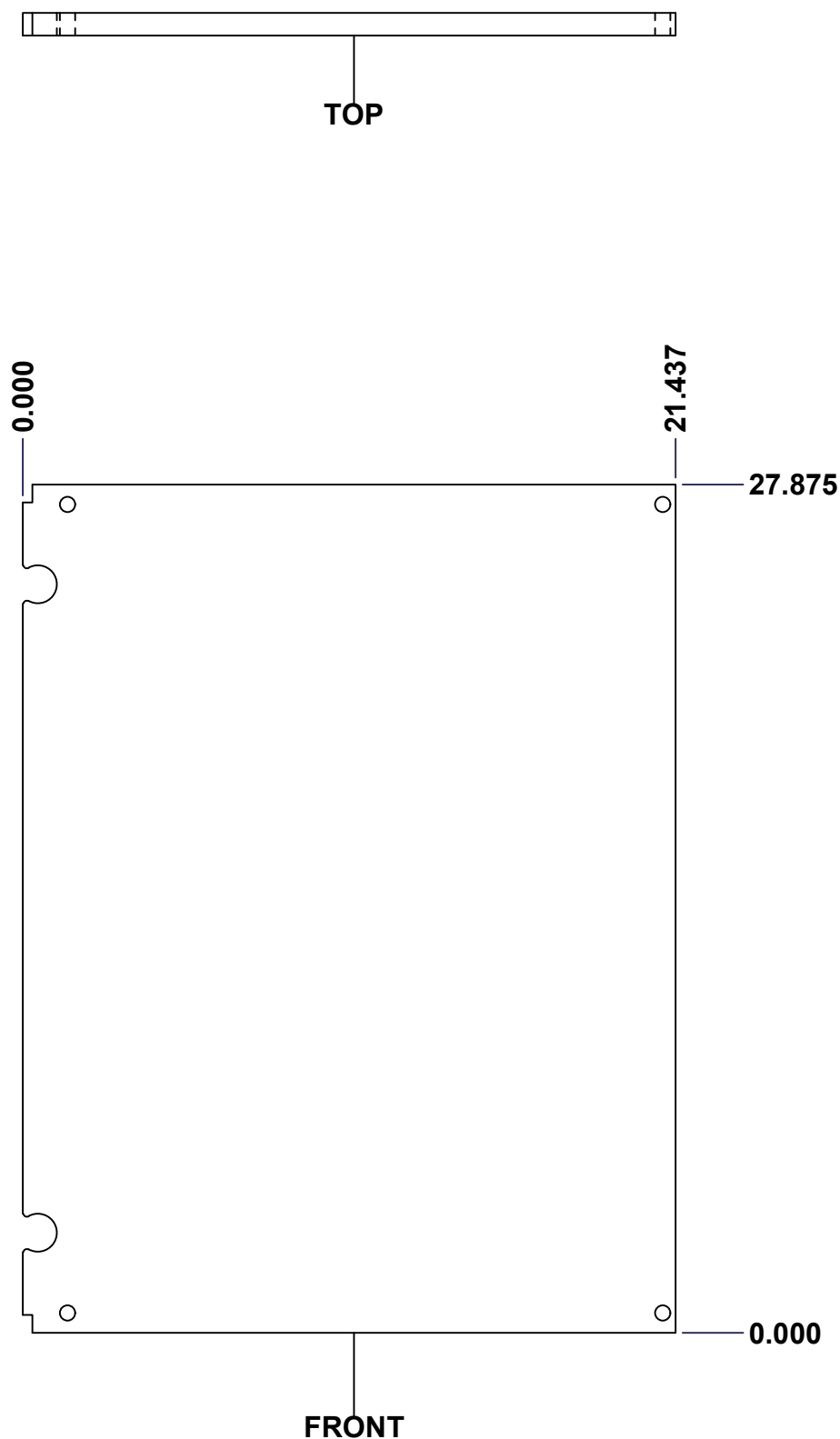

No.	Revisions	Date	By/Par

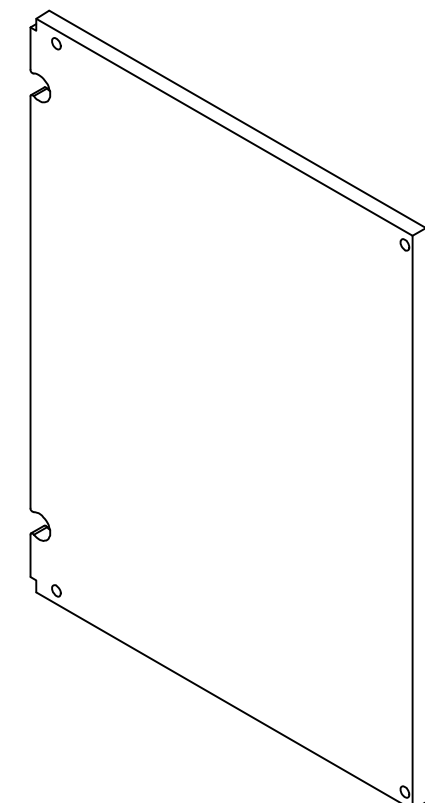

Isometric View



Tél: (450) 979-4373  
 Fax: (450) 979-4626  
[www.exmweb.com](http://www.exmweb.com)

Flatness  
 Aplatissement  
 Max 3.0mm  
 Projection

Customer Client	Date
Drawn By Dessiné Par	Date 23-Jan-07
Material Matière	Polyisocyanurate
Color Couleur	Aluminum
Finish Fini	N/A
Description	Detail Rev.
5412ESSDD 30" x 48" Right Door Insulation	
Part Number Numéro Pièce	Rev. 20
<b>5412ESSDD304810TH-RD</b>	<b>0</b>

SEE BILL OF MATERIAL ON LAST PAGE

This drawing is confidential and must not be reproduced or used without the consent of EXM

Ce dessin est confidentiel et ne doit pas être reproduit ou utilisé sans le consentement de EXM

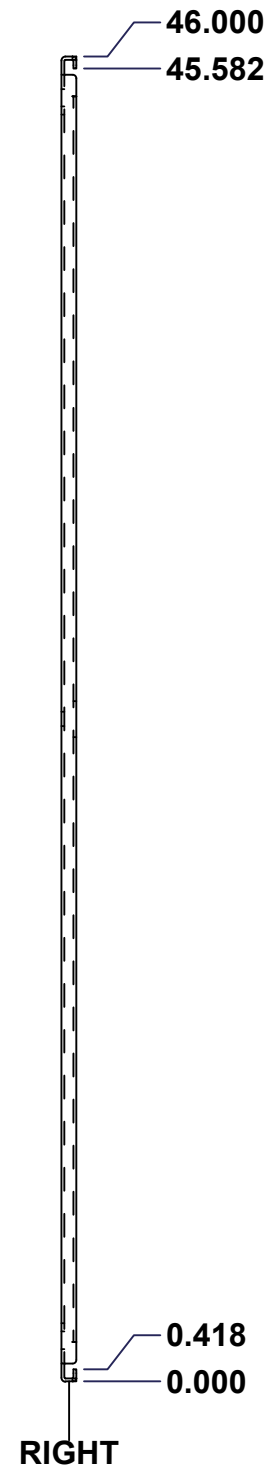
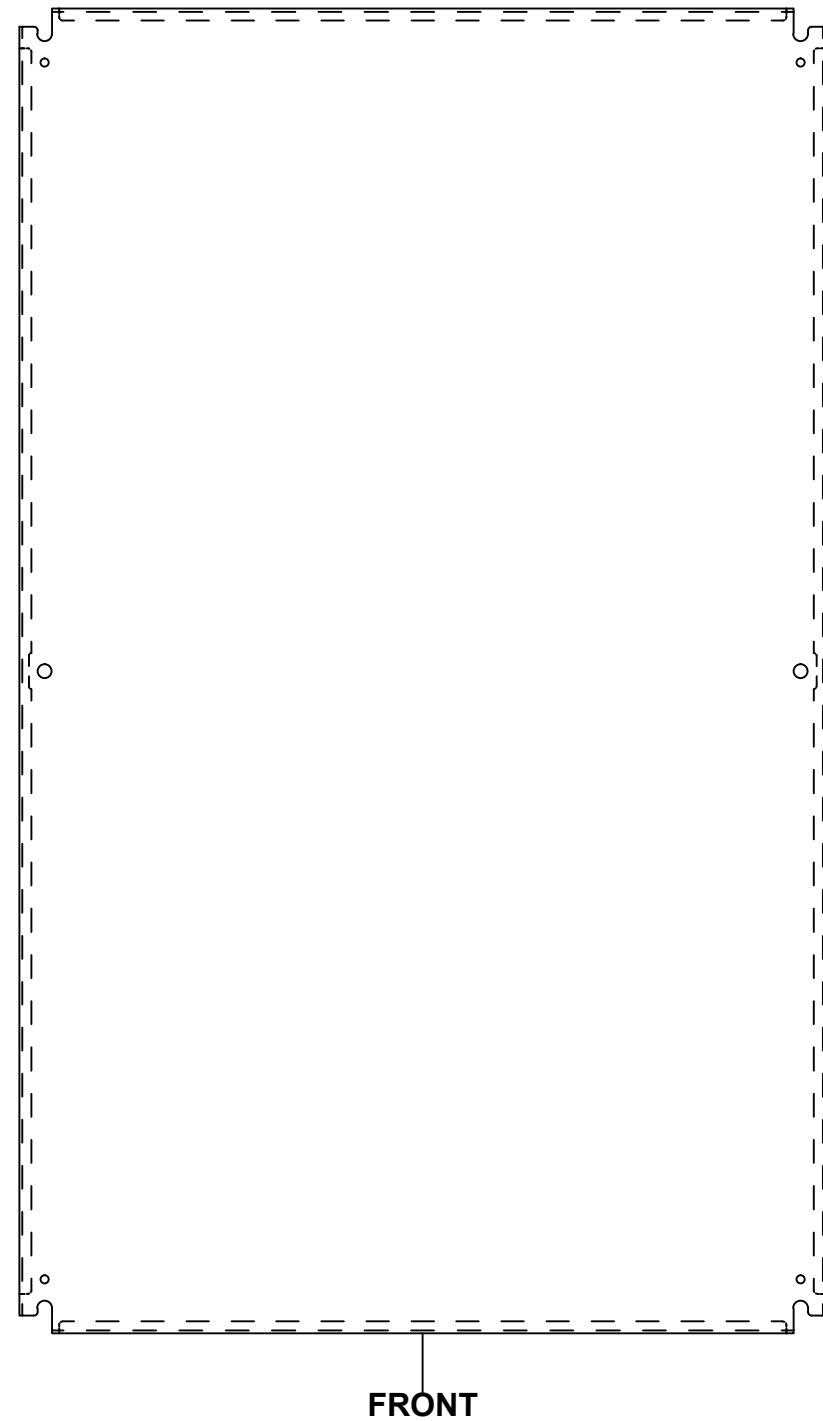
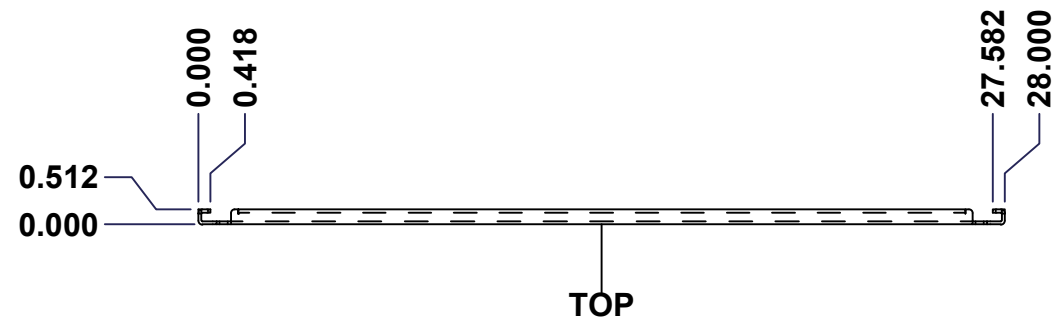

No.	Revisions	Date	By/Par

Isometric View

Tél: (450) 979-4373 Fax: (450) 979-4626 www.exmweb.com	Flatness Aplatissement Max 3.0mm
	Projection 
Customer Client	Date
Drawn By Dessiné Par: BoxCad	Date: 23-Jan-07
Material Matière: See Part List	
Color Couleur: See Part List	Finish Fini: See Part List
Description: 881 SP - Inner Panel	Detail Rev.
Part Number Numéro Pièce: <b>881 SP4830G</b>	Rev. 1 <b>0</b>

Qty	Part Number	Rev	Description	Material	Color	Finish
1	881 SP4830G-P	0	881 SP - Inner Panel Part	12 Ga Galvanized	Unpainted	Galvanized

Parts List

This drawing is confidential and must not be reproduced or used without the consent of EXM

Ce dessin est confidentiel et ne doit pas être reproduit ou utilisé sans le consentement de EXM

Table 1			FRONT VIEW
CUT-OUT	XDIM	YDIM	DESCRIPTION
1	0.875	1.875	GROUND HOLE (RND Ø0.290)
2	27.125	1.875	GROUND HOLE (RND Ø0.290)
3	0.875	44.125	GROUND HOLE (RND Ø0.290)
4	27.125	44.125	GROUND HOLE (RND Ø0.290)
5	0.875	23.000	MTG STUD HOLE (RND Ø0.500)
6	27.125	23.000	MTG STUD HOLE (RND Ø0.500)

All knockouts are actual size / Les disques défonçables sont grandeur réel

No.	Revisions	Date	By/Par

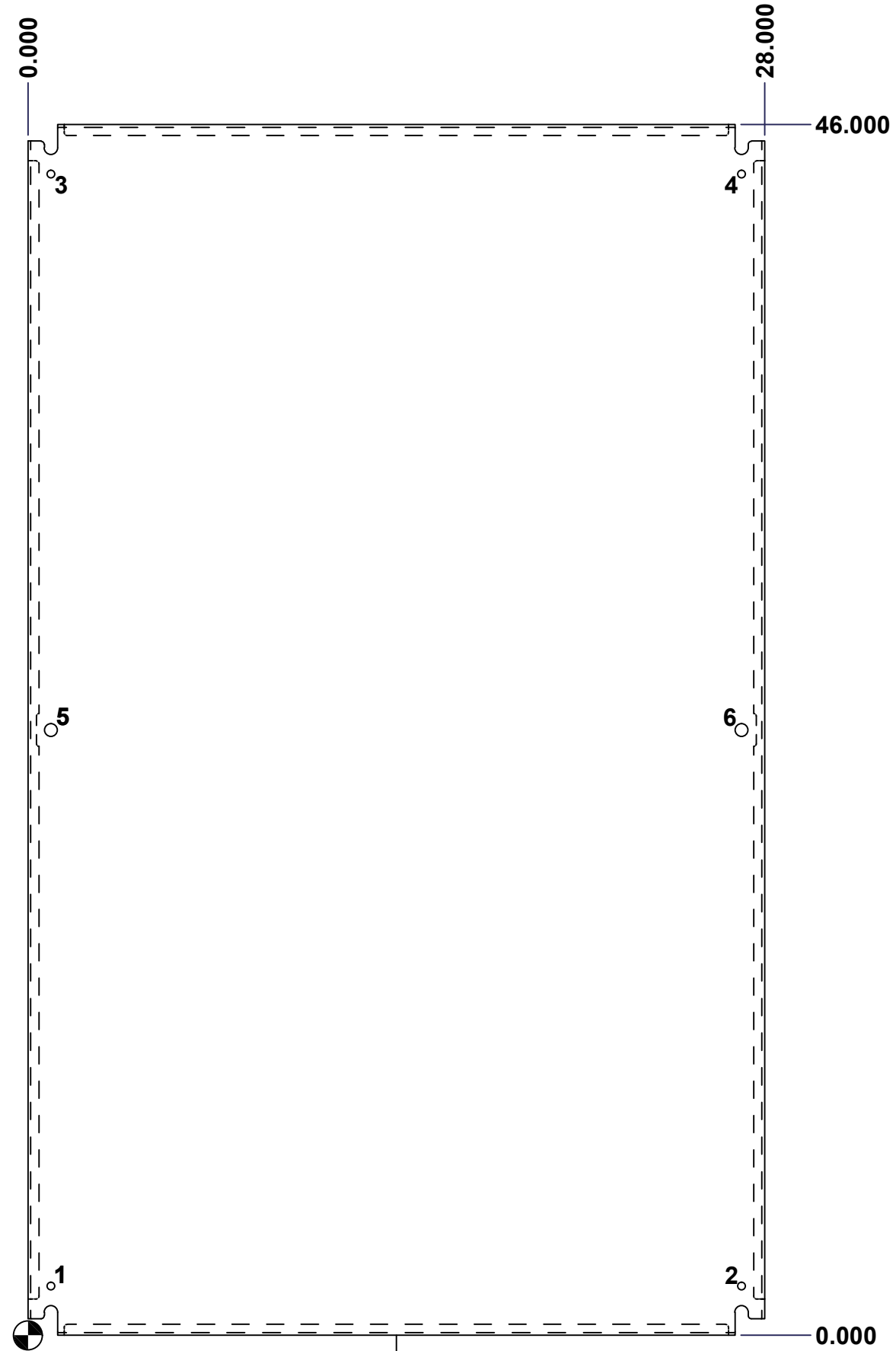

FRONT

Isometric View

<p>Tél: (450) 979-4373 Fax: (450) 979-4626 www.exmweb.com</p>		Flatness Aplatissement
		Max 3.0mm
Customer Client Drawn By / Dessiné Par: BoxCad Material / Matière: See Part List Color / Couleur: See Part List Finish / Fini: See Part List Description: 881 SP - Inner Panel Part Number / Numéro Pièce: <b>881 SP4830G</b>		Projection 
		Date: 23-Jan-07
Detail Rev.		Rev. 2
		0