

This drawing is confidential and must not be reproduced or used without the consent of EXM

Ce dessin est confidentiel et ne doit pas être reproduit ou utilisé sans le consentement de EXM

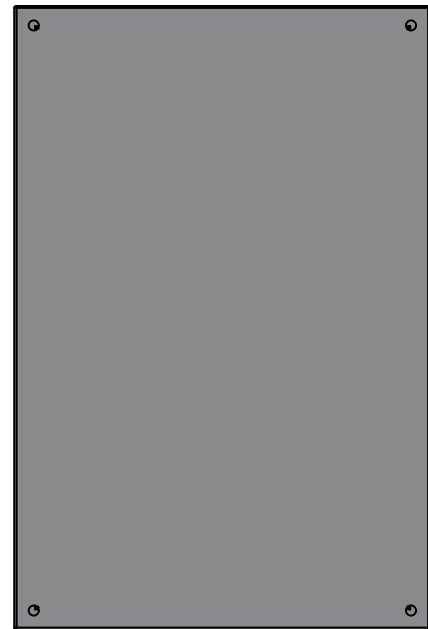

TOP



BACK

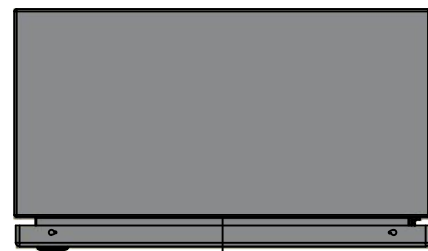

BOTTOM

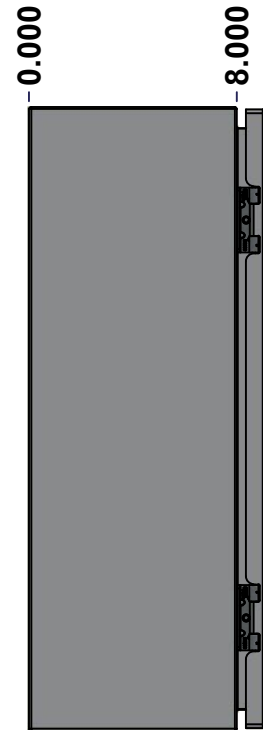

LEFT

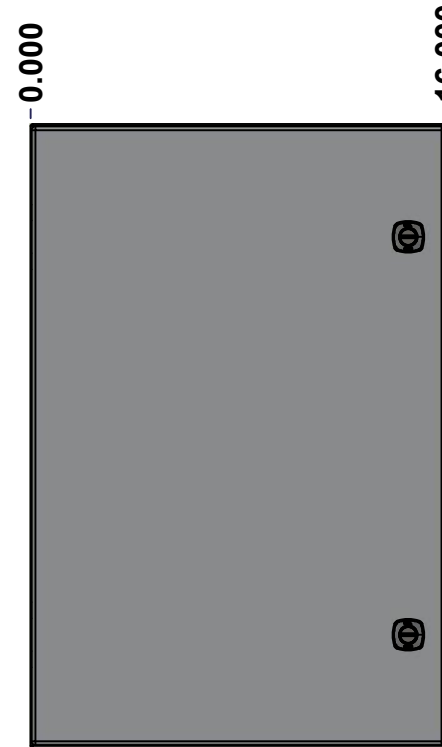

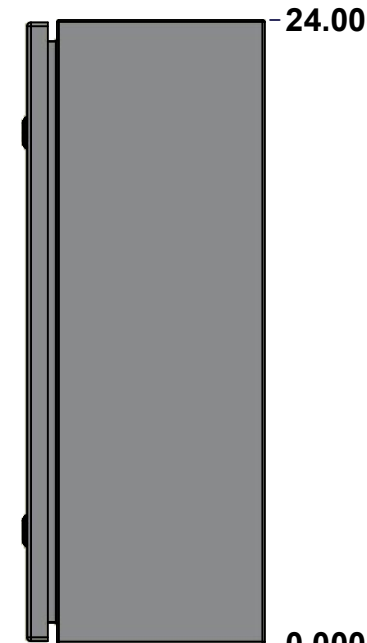

FRONT

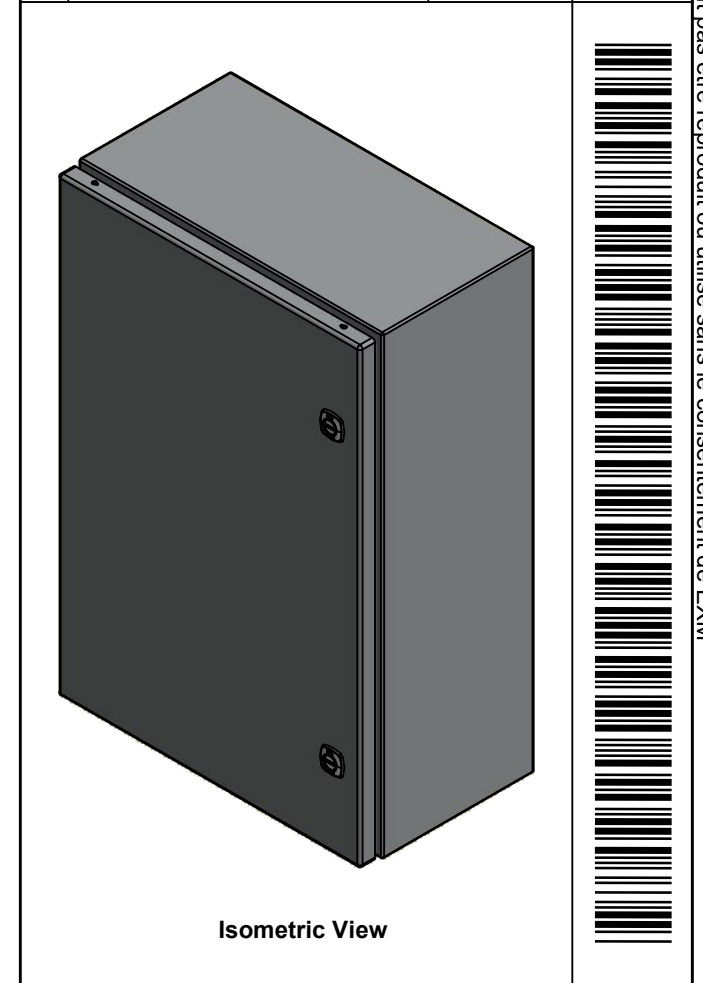

RIGHT

No.	Revisions	Date	By/Par

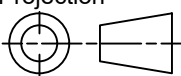

 Tél: (450) 979-4373 Fax: (450) 979-4626 <a href="http://www.exmweb.com">www.exmweb.com</a>		Flatness Aplatissement Max 3.0mm Projection 
Customer Client	Date	
Drawn By Dessiné Par	BoxCad: BoxCad	Date 7/5/2022
Material Matière	16 Ga Stainless Steel 316 (1.4mm)	
Color Couleur	Asa-61 Grey	Finish Fini Smooth
Description 5412ESSP 24" x 16" x 8" Assembly		Detail Rev.
Part Number Numéro Pièce	5412ESSP2416086	Rev. 1 0

SEE BILL OF MATERIAL ON LAST PAGE

This drawing is confidential and must not be reproduced or used without the consent of EXM

Ce dessin est confidentiel et ne doit pas être reproduit ou utilisé sans le consentement de EXM

NOTE	
ITEM	DESCRIPTION
1	NEMA 4X Enclosure
2	C/W Standard ground studs on box and cover
3	C/W Standard door stiffener
4	C/W Standard inner panel (Included)
5	C/W Standard inner panel mounting studs

No.	Revisions	Date	By/Par

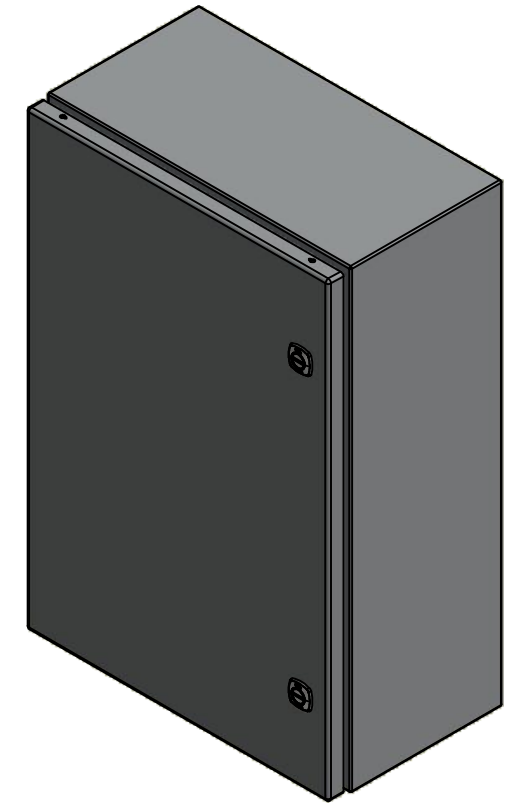

Isometric View

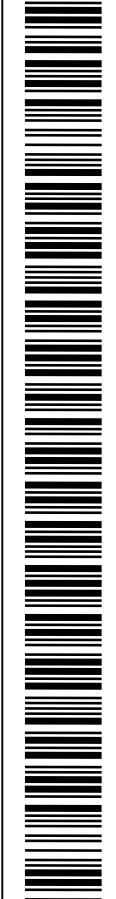

PACKING		
ITEM	QTY	DESCRIPTION
Cardboard sleeve	2	Top and Bottom
Cardboard strip	2	Between back of enclosure and inner panel
Plastic bag	1	To protect cover surface and inside gasket
Plastic strap - Black	2	To Squeeze the 2 cardboard sleeve together
Packaging label	1	White label with product number

1	STK-K-01800	5	5412 ES Accessory Kit
1	880 PP	6	Self Adhesive Print Pocket
1	881 SP2416G	0	881 SP - Inner Panel
1	5412ESSP2416086C	0	5412ESSP 24" x 16" Cover
4	STK-Q-07310	2	Flange Lock Nut M8
4	STK-Q-07610	8	M8 Plastic Spacer 22.2mm
1	5412ESSP2416086B	0	5412ESSP 24" x 16" x 8" Body
2	STK-Q-04051-07	8	M6 x 7mm Stainless Steel Hexagon Socket Head Machine Screw with Nyseal
Qty	Part Number	Rev	Description
Parts List			

	Tél: (450) 979-4373 Fax: (450) 979-4626 <a href="http://www.exmweb.com">www.exmweb.com</a>	Flatness Aplatissement Max 3.0mm Projection 
	Customer Client Date	Date 7/5/2022
Drawn By Dessiné Par	BoxCad: BoxCad	Material Matière 16 Ga Stainless Steel 316 (1.4mm)
Color Couleur Asa-61 Grey	Finish Fini Smooth	Description 5412ESSP 24" x 16" x 8" Assembly Detail Rev.
Part Number Numéro Pièce <b>5412ESSP2416086</b>	Rev. 0	2 9

This drawing is confidential and must not be reproduced or used without the consent of EXM

Ce dessin est confidentiel et ne doit pas être reproduit ou utilisé sans le consentement de EXM



TOP

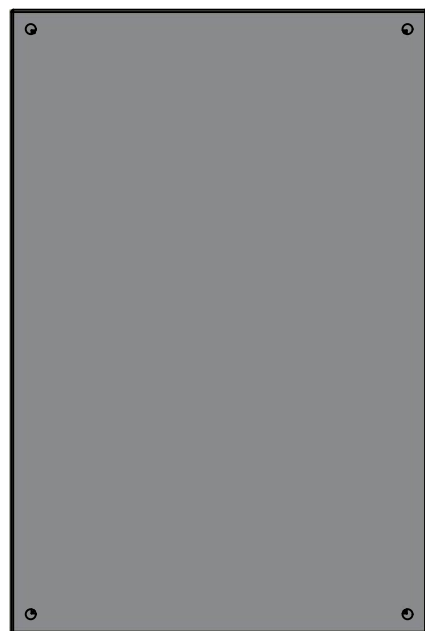

BACK



BOTTOM

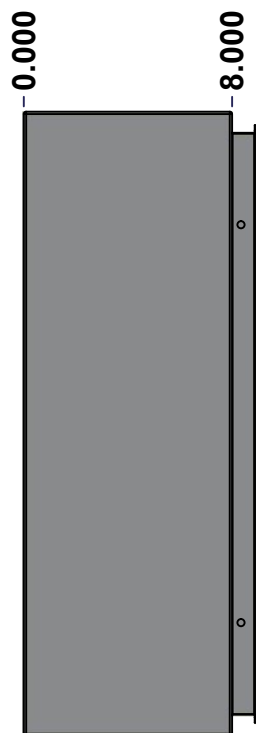

LEFT

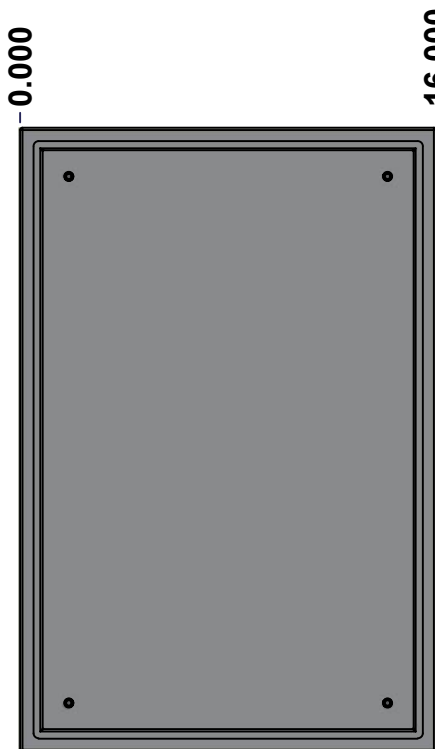

FRONT

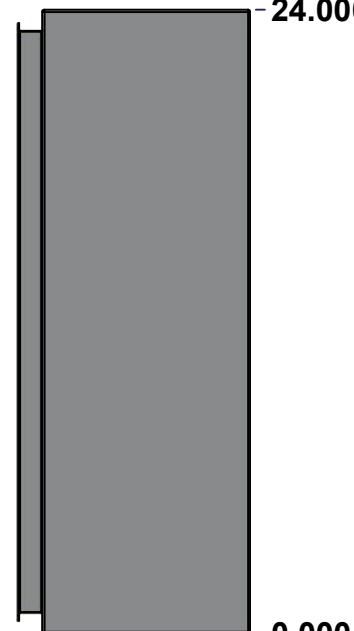

RIGHT

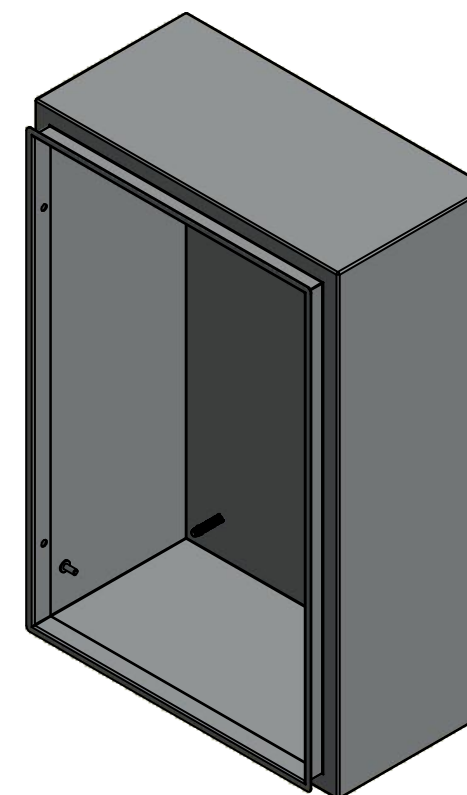

Isometric View

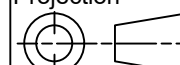

No.	Revisions	Date	By/Par

 Tél: (450) 979-4373 Fax: (450) 979-4626 <a href="http://www.exmweb.com">www.exmweb.com</a>		Flatness Aplatissement Max 3.0mm Projection 
Customer Client	Date	
Drawn By Dessiné Par	BoxCad: BoxCad	Date 7/5/2022
Material Matière	16 Ga Stainless Steel 316 (1.4mm)	
Color Couleur	Asa-61 Grey	Finish Fini Smooth
Description	Detail Rev.	
5412ESSP 24" x 16" x 8" Body		
Part Number Numéro Pièce	Rev. 0	3 9

SEE BILL OF MATERIAL ON LAST PAGE

**5412ESSP2416086B**

This drawing is confidential and must not be reproduced or used without the consent of EXM

Ce dessin est confidentiel et ne doit pas être reproduit ou utilisé sans le consentement de EXM

<b>STANDARD FEATURES ARE NOT LISTED IN THIS HOLE TABLE</b>			
<b>HOLE TABLE - LEFT VIEW (CUSTOM FEATURE ONLY)</b>			
CUT-OUT	XDIM	YDIM	DESCRIPTION
1	6.500	2.000	GND STUD M6 x 16mm (Inside)

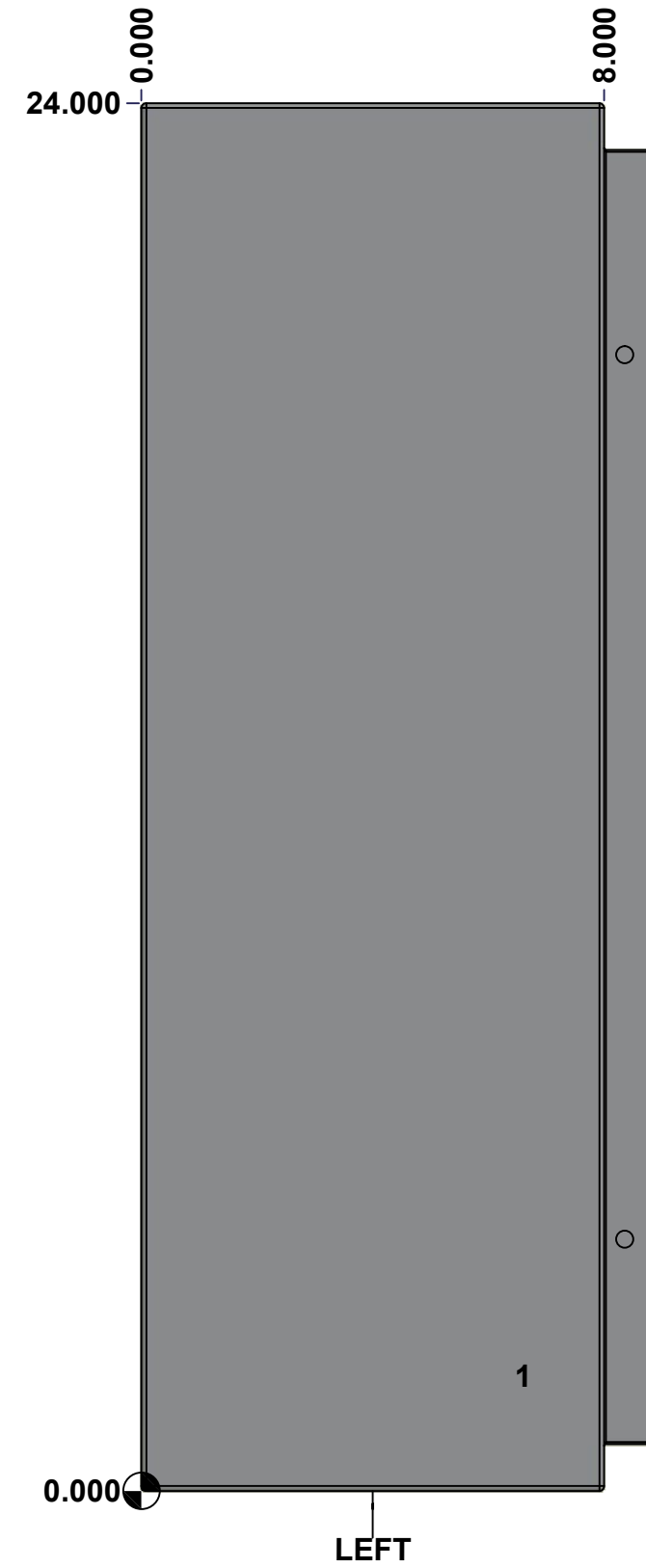

	Description	Status	
	5412ESSP 24" x 16" x 8" Body	(NULL)	
	Part Number Numéro Pièce	Rev.	
	<b>5412ESSP2416086B</b>	<b>0</b>	4/9

This drawing is confidential and must not be reproduced or used without the consent of EXM

Ce dessin est confidentiel et ne doit pas être reproduit ou utilisé sans le consentement de EXM

**STANDARD FEATURES ARE NOT LISTED IN THIS HOLE TABLE**

**HOLE TABLE - BACK VIEW (CUSTOM FEATURE ONLY)**

CUT-OUT	XDIM	YDIM	DESCRIPTION
1	1.875	1.875	IP STUD M8 x 35mm (Inside)
2	1.875	22.125	IP STUD M8 x 35mm (Inside)
3	14.125	22.125	IP STUD M8 x 35mm (Inside)
4	14.125	1.875	IP STUD M8 x 35mm (Inside)
-----			
5	15.250	0.750	RND Ø0.390
6	15.250	23.250	RND Ø0.390
7	0.750	23.250	RND Ø0.390
8	0.750	0.750	RND Ø0.390

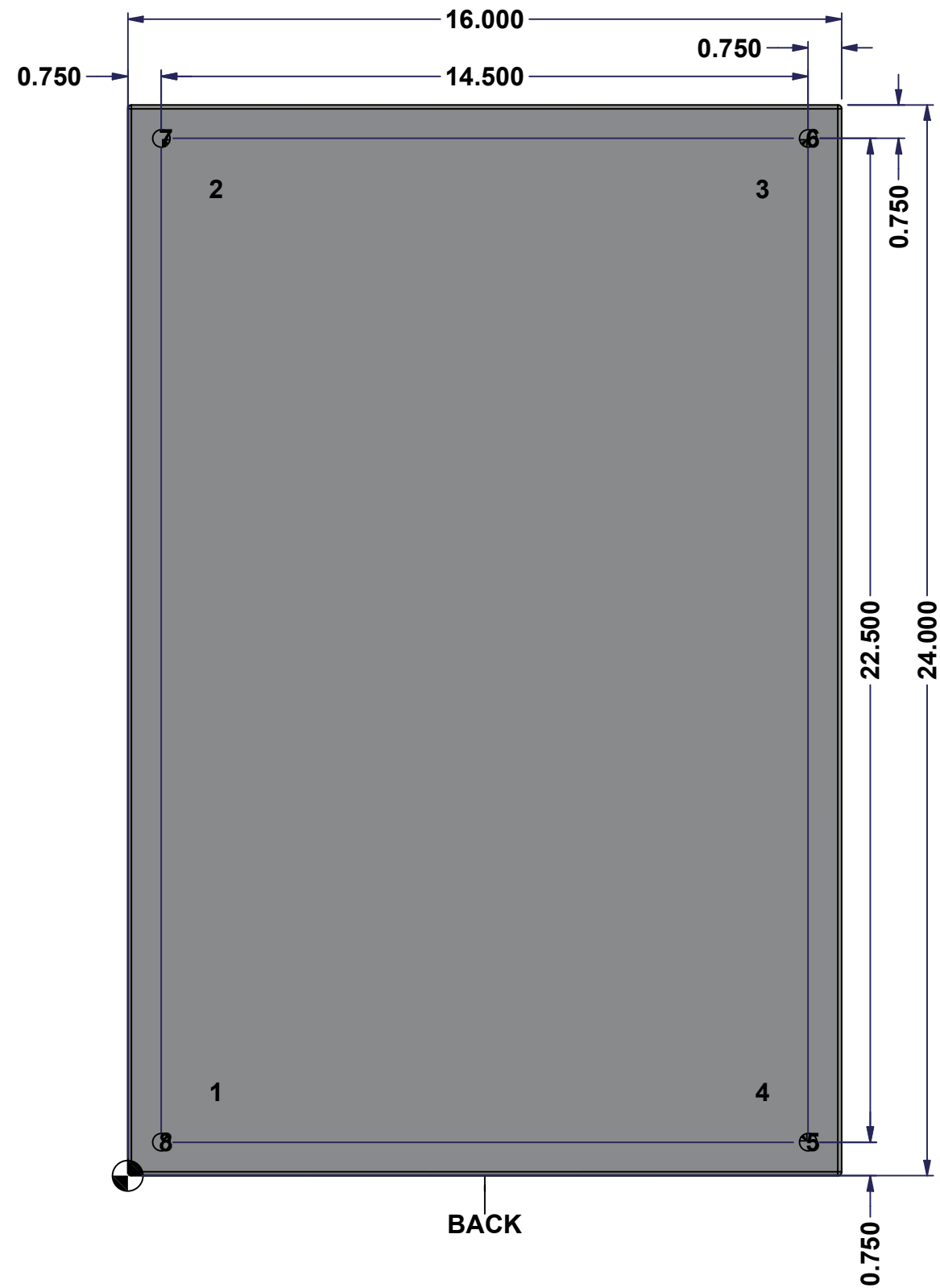

BACK

	Description	Status
	5412ESSP 24" x 16" x 8" Body	(NULL)
	Part Number	Rev.
	Numéro Pièce	5
	<b>5412ESSP2416086B</b>	<b>0</b>
		9

This drawing is confidential and must not be reproduced or used without the consent of EXM

Ce dessin est confidentiel et ne doit pas être reproduit ou utilisé sans le consentement de EXM

No.	Revisions	Date	By/Par

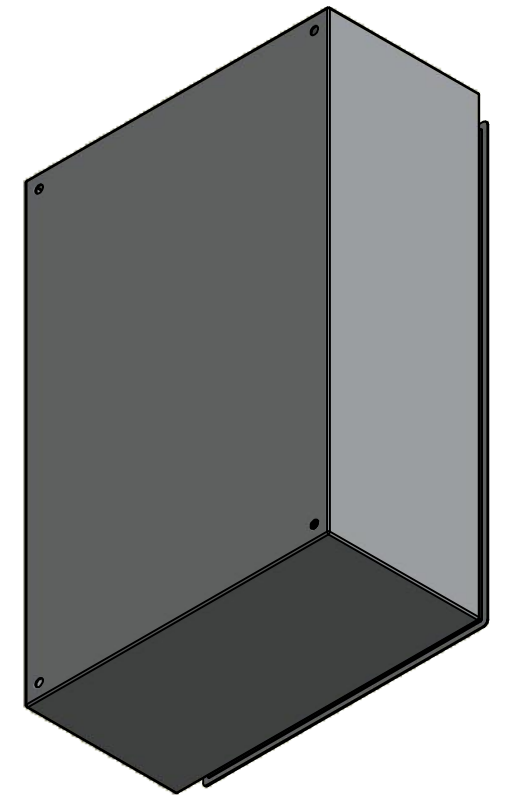

Isometric View



 Tél: (450) 979-4373 Fax: (450) 979-4626 <a href="http://www.exmweb.com">www.exmweb.com</a>		Flatness Aplatissement Max 3.0mm
Customer Client		Date
Drawn By Dessiné Par	BoxCad: BoxCad	Date 7/5/2022
Material Matière 16 Ga Stainless Steel 316 (1.4mm)		
Color Couleur	Asa-61 Grey	Finish Fini Smooth
Description 5412ESSP 24" x 16" x 8" Body		Detail Rev.
Part Number Numéro Pièce <b>5412ESSP2416086B</b>		Rev. 6 <b>0</b>

Qty	Part Number	Rev	Description
1	STK-Q-16085	0	Ground Stud M6 x 16mm Stainless Steel
1	STK-P-02400S	0	Powder Paint (Asa-61 Grey / Smooth)
4	STK-Q-16020	1	Stud M8 x 35mm Stainless Steel
1	5412ESSP2416086B-P	0	5412ESSP 24" x 16" x 8" Body Part
Parts List			

This drawing is confidential and must not be reproduced or used without the consent of EXM

Ce dessin est confidentiel et ne doit pas être reproduit ou utilisé sans le consentement de EXM

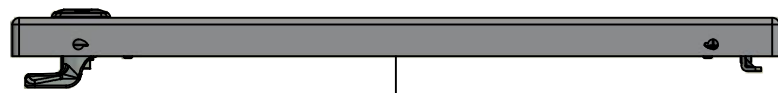

TOP

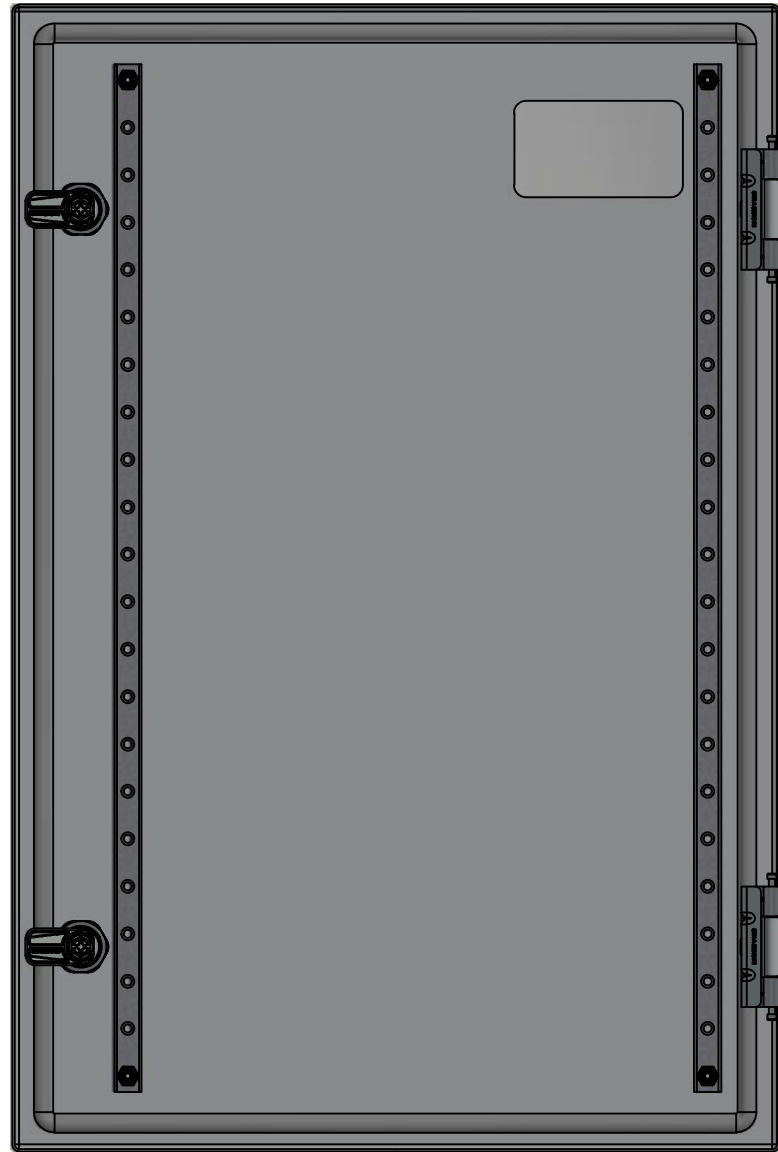

BACK



BOTTOM

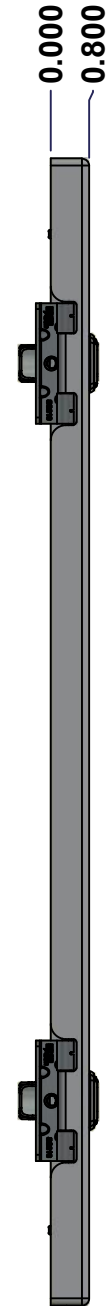

LEFT

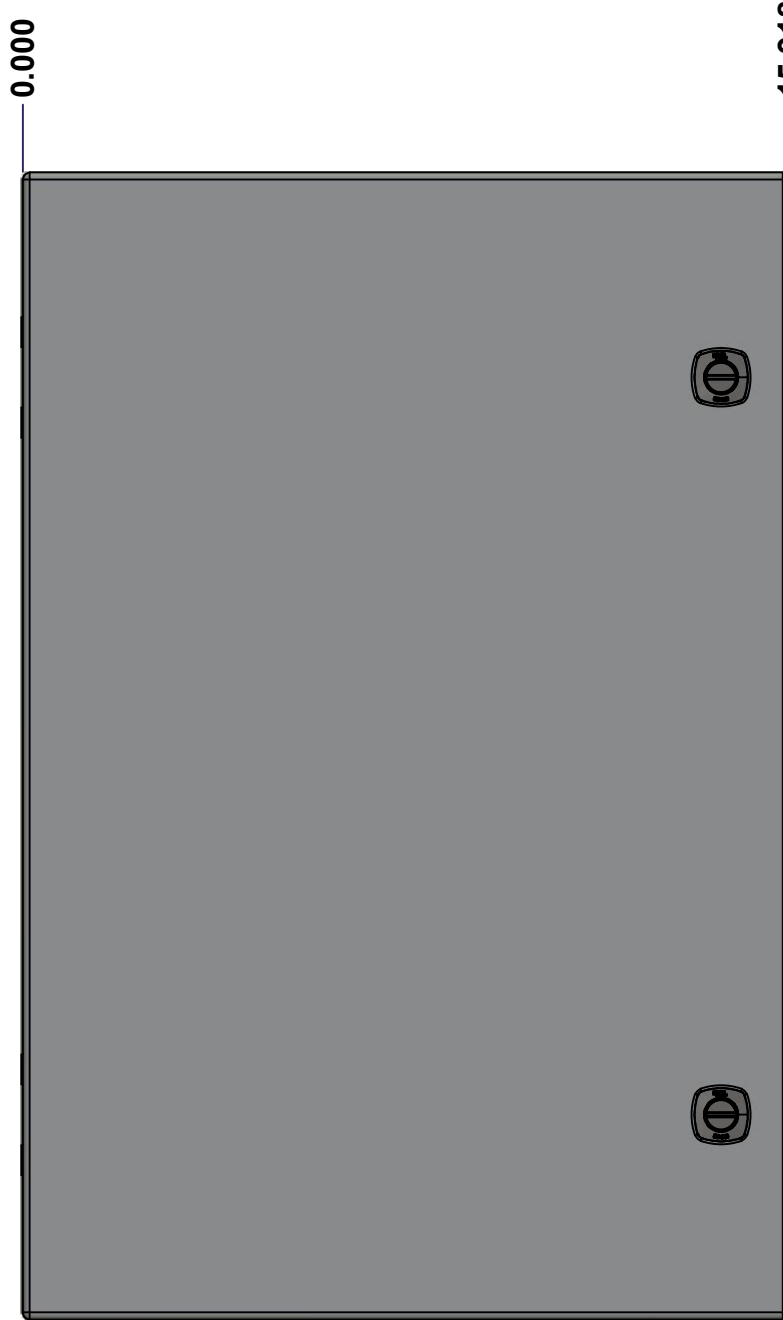

FRONT

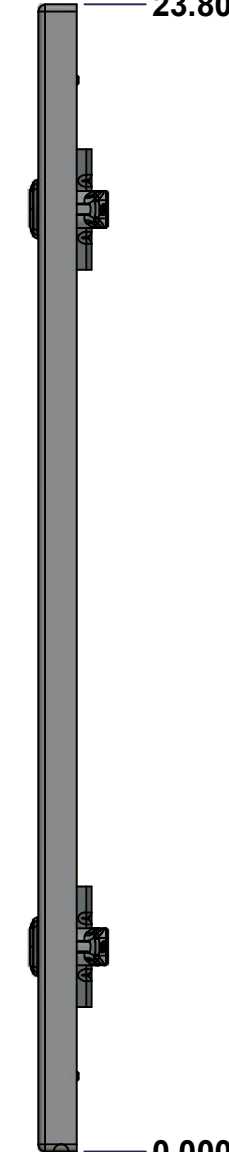

RIGHT

0.000  
0.800

0.000

15.918

23.803

0.000

No.	Revisions	Date	By/Par

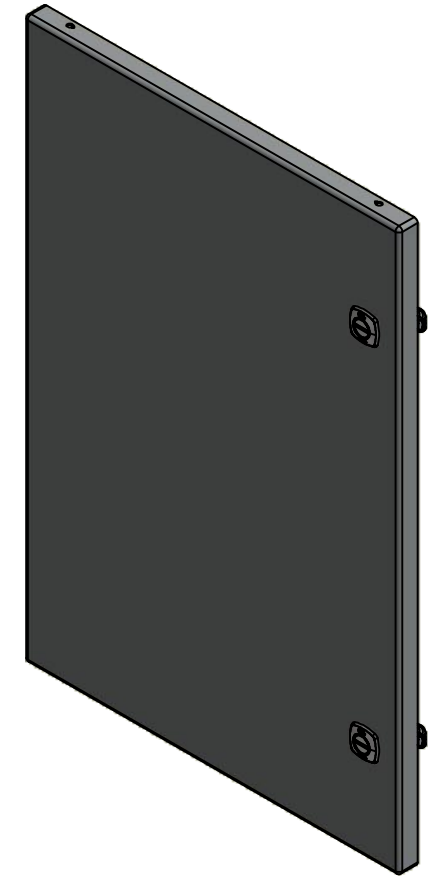

Isometric View



Tél: (450) 979-4373  
Fax: (450) 979-4626  
[www.exmweb.com](http://www.exmweb.com)

Flatness  
Aplatissement

Max 3.0mm

Projection

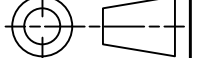

Customer Client	Date
Drawn By Dessiné Par BoxCad: BoxCad	Date 7/5/2022
Material Matière 16 Ga Stainless Steel 316 (1.4mm)	
Color Couleur Asa-61 Grey	Finish Fini Smooth
Description 5412ESSP 24" x 16" Cover	Detail Rev.
Part Number Numéro Pièce <b>5412ESSP2416086C</b>	Rev. 7 <b>0</b>

SEE BILL OF MATERIAL ON LAST PAGE

This drawing is confidential and must not be reproduced or used without the consent of EXM

Ce dessin est confidentiel et ne doit pas être reproduit ou utilisé sans le consentement de EXM

**STANDARD FEATURES ARE NOT LISTED IN THIS HOLE TABLE**

**HOLE TABLE - FRONT VIEW (CUSTOM FEATURE ONLY)**

CUT-OUT	XDIM	YDIM	DESCRIPTION
1	1.486	1.567	STUD M6 x 18mm (Inside)
2	1.486	22.236	STUD M6 x 18mm (Inside)
3	13.517	22.236	STUD M6 x 18mm (Inside)
4	13.517	1.567	STUD M6 x 18mm (Inside)
-----			
5	3.750	20.803	LABEL_EXM (Inside)
6	14.494	19.553	LOCK 880 SCQ4-SLSS6 @ 0.0°
7	14.494	4.250	LOCK 880 SCQ4-SLSS6 @ 0.0°

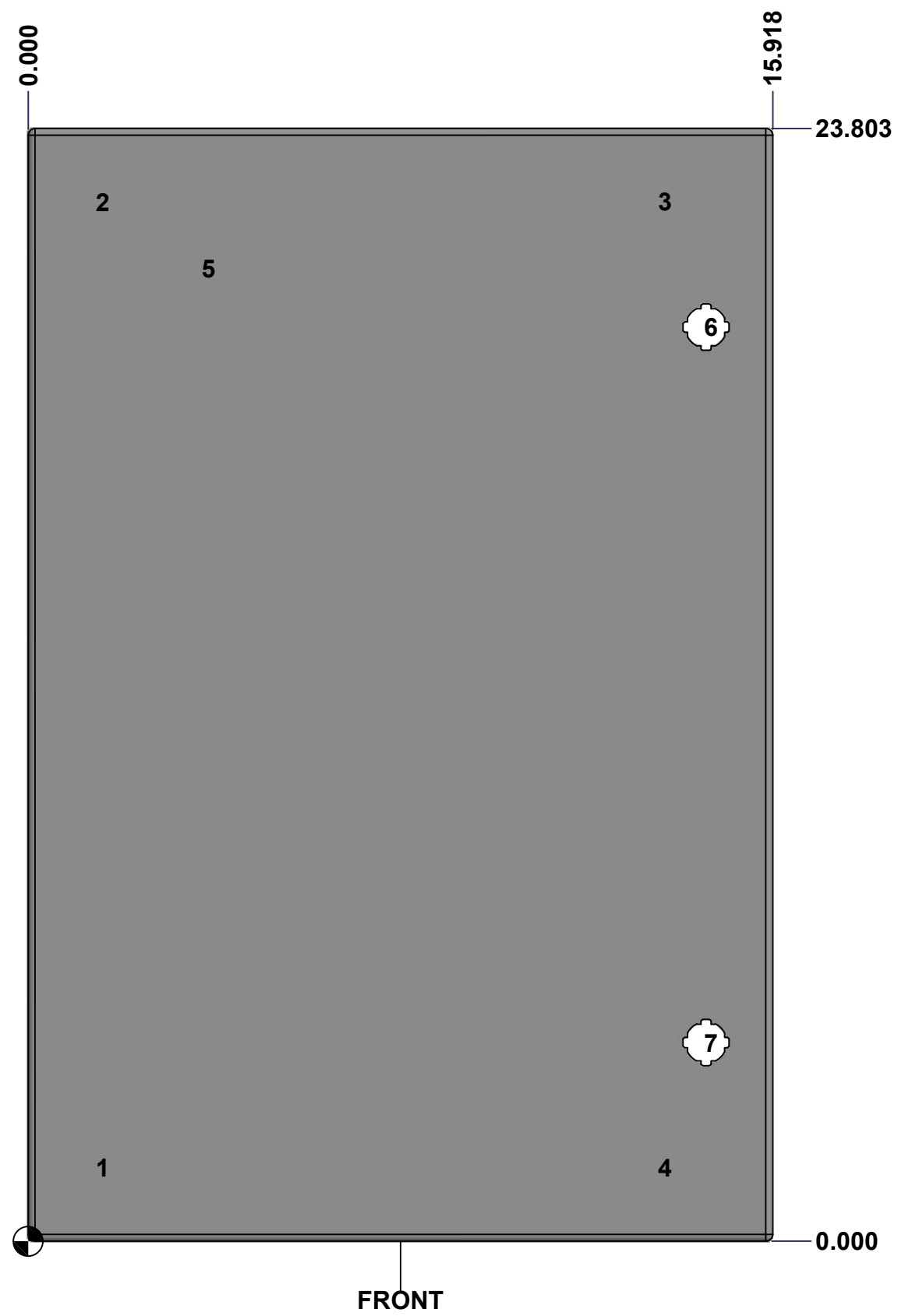

FRONT

	Description	Status	
	5412ESSP 24" x 16" Cover	(NULL)	
	Part Number Numéro Pièce	Rev.	
	<b>5412ESSP2416086C</b>	<b>0</b>	8 9

This drawing is confidential and must not be reproduced or used without the consent of EXM

Ce dessin est confidentiel et ne doit pas être reproduit ou utilisé sans le consentement de EXM

No.	Revisions	Date	By/Par

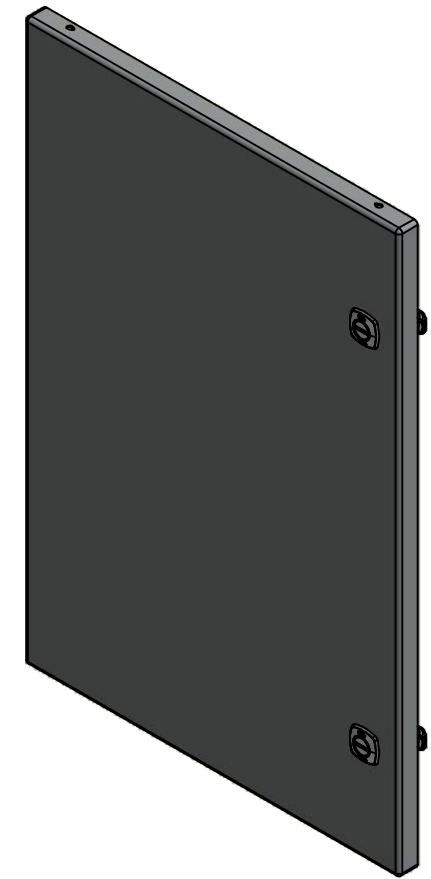

Isometric View



 Tél: (450) 979-4373 Fax: (450) 979-4626 <a href="http://www.exmweb.com">www.exmweb.com</a>	Flatness Aplatissement
	Max 3.0mm
	Projection
	

Customer Client	Date
Drawn By Dessiné Par	Date 7/5/2022

Material Matière: 16 Ga Stainless Steel 316 (1.4mm)

Color Couleur	Asa-61 Grey	Finish Fini	Smooth
---------------	-------------	-------------	--------

Description	Detail Rev.
5412ESSP 24" x 16" Cover	

Part Number Numéro Pièce	Rev.	9
<b>5412ESSP2416086C</b>	<b>0</b>	9

Qty	Part Name	Rev	Description
1	STK-S-00100	0	3.5" x 2" Silver Milar Flexcon Sticker
1	STK-P-02400S	0	Powder Paint (Asa-61 Grey / Smooth)
2	STK-Q-46020-24	5	5412 ES Vertical Door Stiffener 24"
4	STK-Q-16070	1	Stud M6 x 18mm Stainless steel
1	5412ESSP2416086G	0	5412ESSP 24" x 16" Cover Gasket Part
1	5412ESSP2416086C-P	0	5412ESSP 24" x 16" Cover Part
2	STK-A-33016	0	5412 ESS Bended Hinge (Body Part)
2	880 SCQ4-SLSS6	7	5412 ESS 1/4 Turn Lock
4	STK-Q-07220	1	M6 Nylon Insert Lock Nut
Parts List			

This drawing is confidential and must not be reproduced or used without the consent of EXM

Ce dessin est confidentiel et ne doit pas être reproduit ou utilisé sans le consentement de EXM

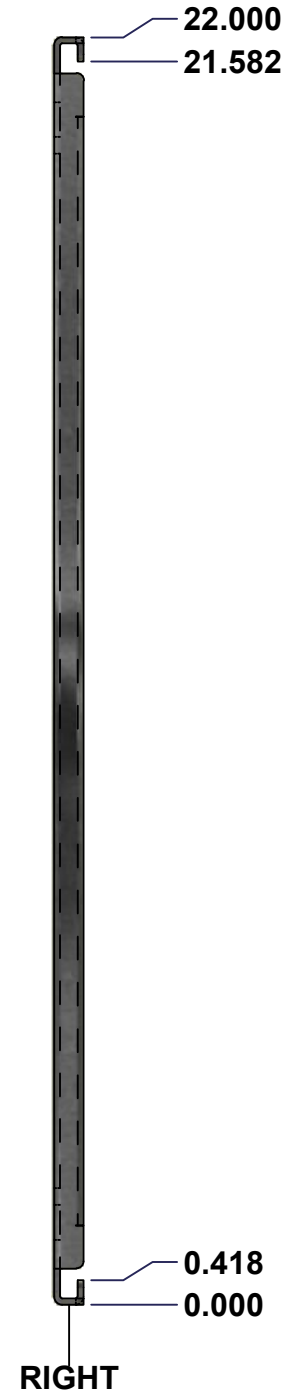
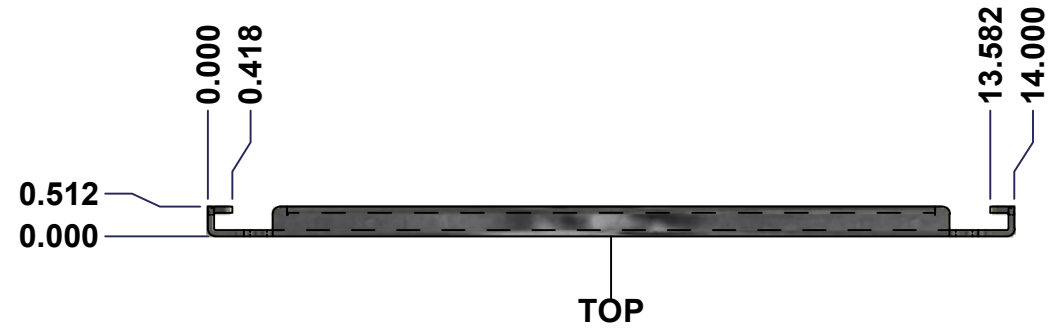

No.	Revisions	Date	By/Par

Isometric View

<p>Tél: (450) 979-4373 Fax: (450) 979-4626 www.exmweb.com</p>	Flatness Aplatissement	Max 3.0mm
	Projection	
Customer Client	Date	
Drawn By Dessiné Par	BoxCad	Date 1/23/2007
Material Matière	See Part List	
Color Couleur	See Part List	Finish Fini See Part List
Description	Detail Rev.	
881 SP - Inner Panel		
Part Number Numéro Pièce	881 SP2416G	Rev. 1 0 2

Qty	Part Number	Rev	Description	Material	Color	Finish
1	881 SP2416G-P	0	881 SP - Inner Panel Part	12 Ga Galvanized	Unpainted	Galvanized

Parts List

This drawing is confidential and must not be reproduced or used without the consent of EXM

Ce dessin est confidentiel et ne doit pas être reproduit ou utilisé sans le consentement de EXM

Table 1			FRONT VIEW
CUT-OUT	XDIM	YDIM	DESCRIPTION
1	0.875	1.875	GROUND HOLE (RND Ø0.290)
2	13.125	1.875	GROUND HOLE (RND Ø0.290)
3	0.875	20.125	GROUND HOLE (RND Ø0.290)
4	13.125	20.125	GROUND HOLE (RND Ø0.290)

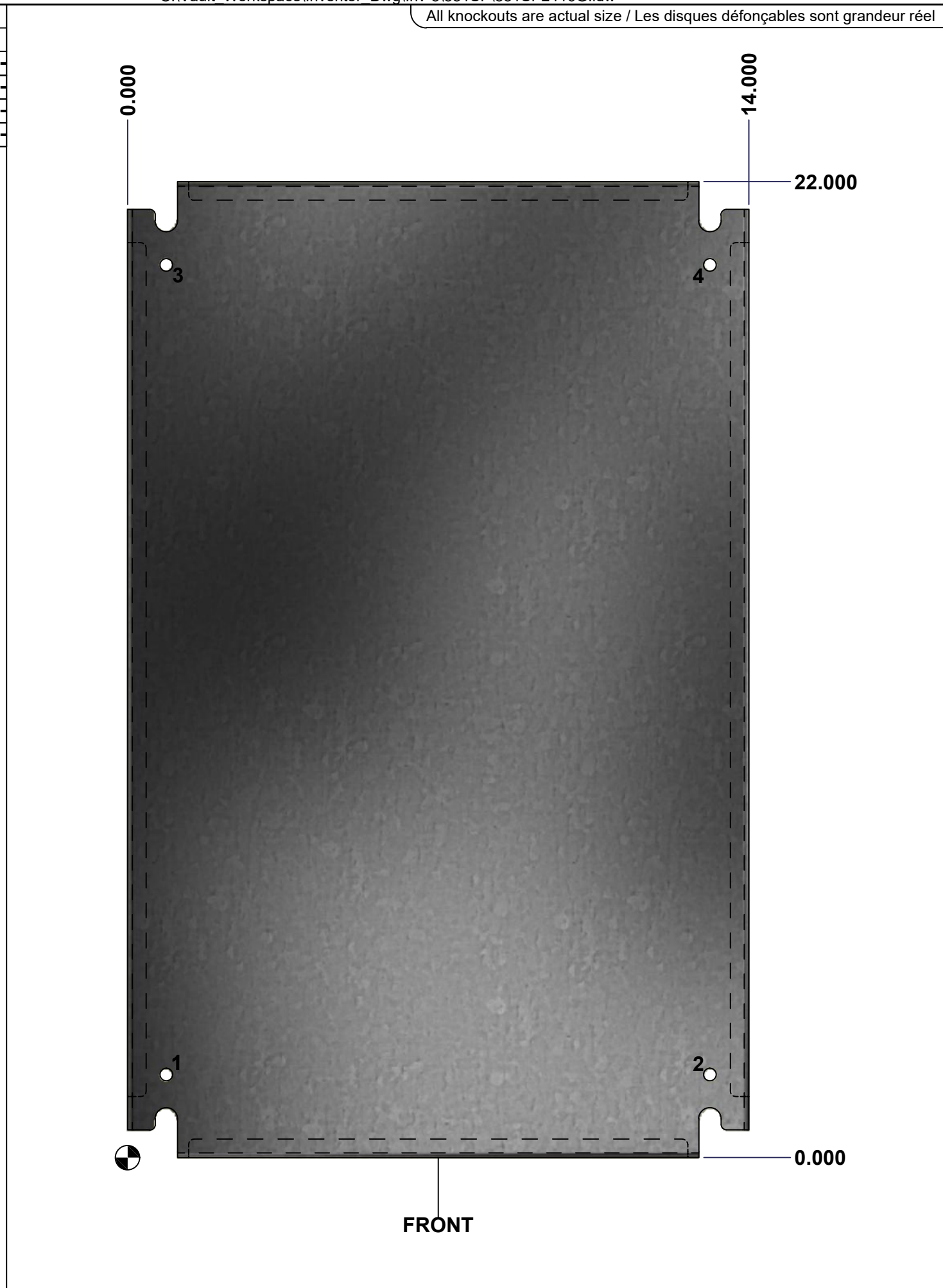

All knockouts are actual size / Les disques défonçables sont grandeur réel

No.	Revisions	Date	By/Par



Tél: (450) 979-4373 Fax: (450) 979-4626 www.exmweb.com		Flatness Aplatissement Max 3.0mm Projection 
Customer Client		Date
Drawn By Dessiné Par	BoxCad	Date 1/23/2007
Material Matière	See Part List	
Color Couleur	See Part List	Finish Fini See Part List
Description	Detail Rev.	
	881 SP - Inner Panel	
Part Number Numéro Pièce	Rev.	
<b>881 SP2416G</b>	<b>0</b>	2 / 2