

This drawing is confidential and must not be reproduced or used without the consent of EXM

Ce dessin est confidentiel et ne doit pas être reproduit ou utilisé sans le consentement de EXM

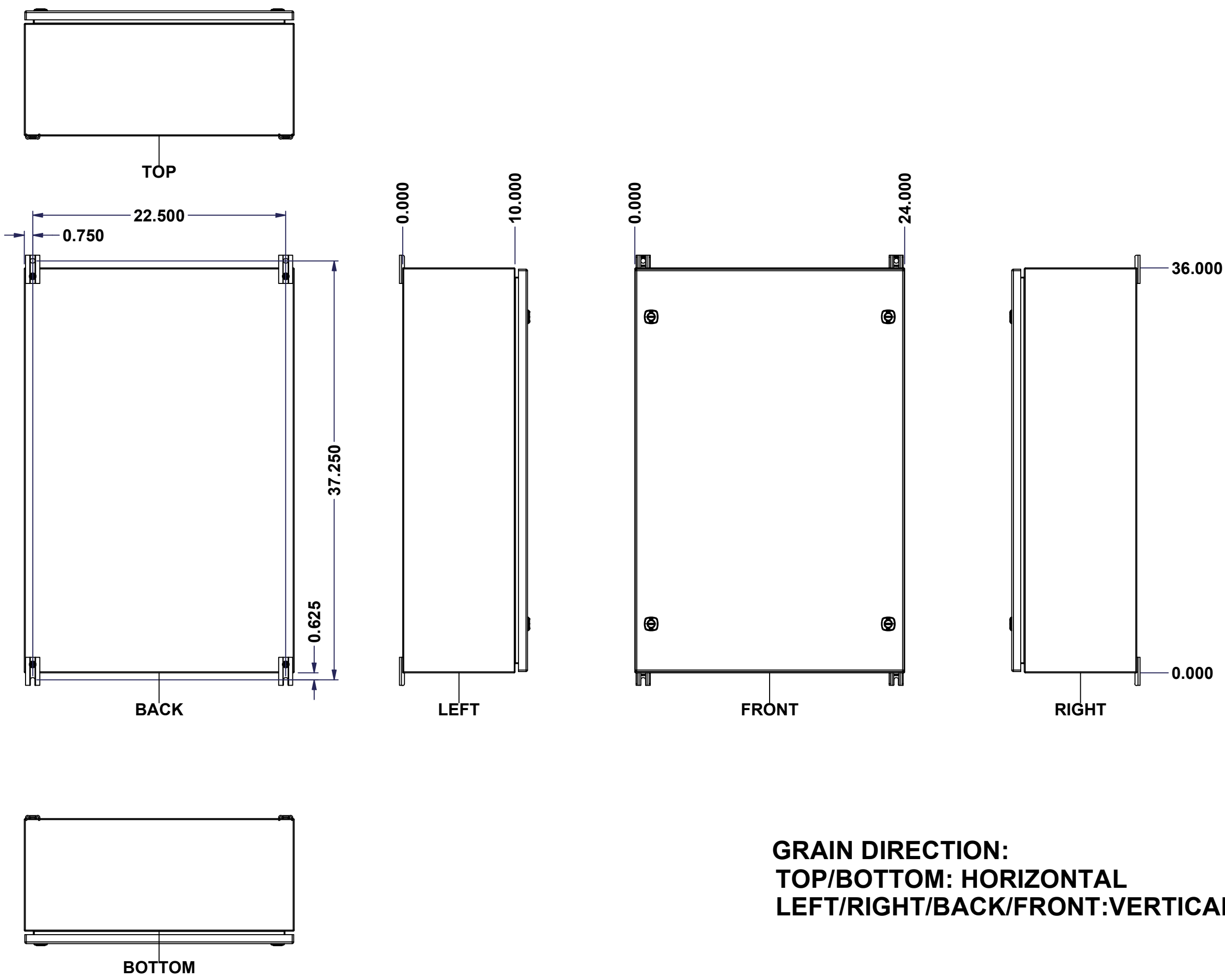

No.	Revisions	Date	By/Par

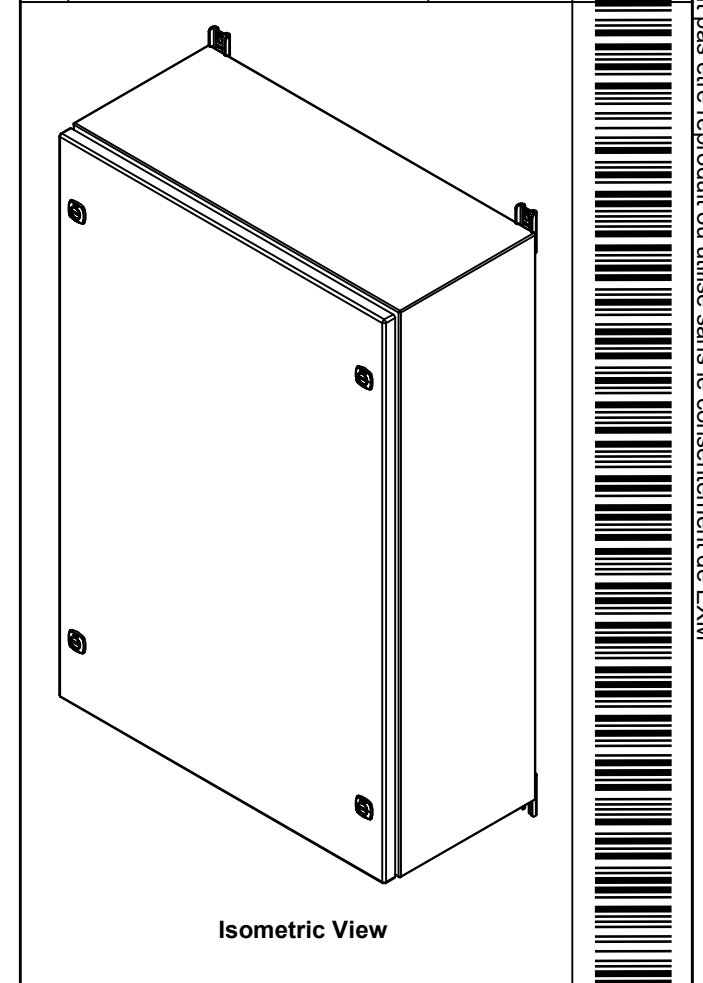

**GRAIN DIRECTION:  
TOP/BOTTOM: HORIZONTAL  
LEFT/RIGHT/BACK/FRONT: VERTICAL**

Tél: (450) 979-4373 Fax: (450) 979-4626 <a href="http://www.exmweb.com">www.exmweb.com</a>		Flatness Aplatissement Max 3.0mm Projection 
Customer Client	Date	
Drawn By Dessiné Par	BoxCad: BoxCad	Date 13-Feb-26
Material Matière	16 Ga Stainless Steel 316 (1.4mm)	
Color Couleur	Unpainted	Finish Fini Brushed
Description	Detail Rev.	
5412ESSQT 36" x 24" x 10" Assembly		
Part Number Numéro Pièce	Rev.	1
SEE BILL OF MATERIAL ON LAST PAGE	<b>5412ESSQT3624106TH</b>	<b>0</b>

This drawing is confidential and must not be reproduced or used without the consent of EXM

Ce dessin est confidentiel et ne doit pas être reproduit ou utilisé sans le consentement de EXM

NOTE	
ITEM	DESCRIPTION
1	NEMA 4X Enclosure (IP66)
2	C/W Standard ground studs on box and cover
3	C/W Standard door stiffener
4	C/W Standard inner panel (Included)
5	C/W Standard inner panel mounting studs
6	C/W 885 ESMF4_OPEN Sold separately (Installed)
7	C/W 885 ESMF4_CLOSE Sold separately (Installed)
8	C/W R5 Insulation (Installed aluminum visible)

No.	Revisions	Date	By/Par

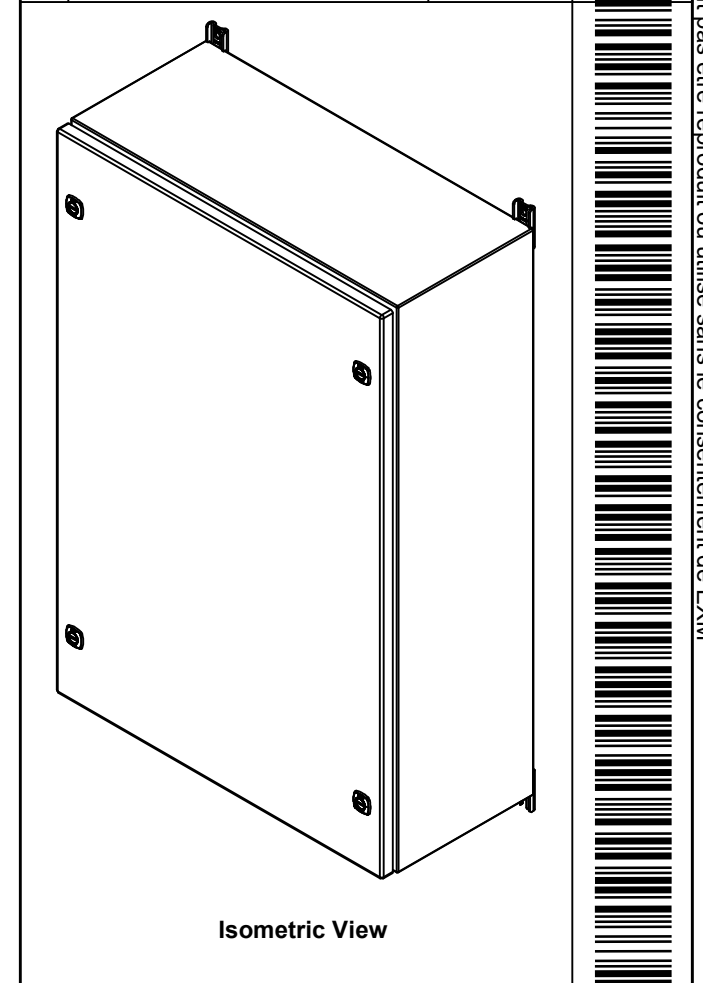

	Tél: (450) 979-4373 Fax: (450) 979-4626 <a href="http://www.exmweb.com">www.exmweb.com</a>	Flatness Aplatissement Max 3.0mm Projection
		Customer Client Date
Drawn By Dessiné Par	BoxCad: BoxCad	Date 13-Feb-26
Material Matière	16 Ga Stainless Steel 316 (1.4mm)	
Color Couleur	Unpainted	Finish Fini Brushed
Description 5412ESSQT 36" x 24" x 10" Assembly		Detail Rev.
Part Number Numéro Pièce <b>5412ESSQT3624106TH</b>	Rev. <b>0</b>	2 16

PACKING		
ITEM	QTY	DESCRIPTION
Cardboard sleeve	2	Top and Bottom
Cardboard strip	2	Between back of enclosure and inner panel
Plastic bag	1	To protect cover surface and inside gasket
Plastic strap - Black	2	To Squeeze the 2 cardboard sleeve together
Packaging label	1	White label with product number

1	STK-K-01800	5	5412 ES Accessory Kit
6	STK-Q-00600	2	M12 to M8 Adaptor
1	881 SP3624G	0	881 SP - Inner Panel
1	5412ESSQT3624106THC	0	5412ESSQT 36" x 24" Cover
1	5412ESSQT3624106THB	0	5412ESSQT 36" x 24" x 10" Body
Qty	Part Number	Rev	Description
Parts List			

This drawing is confidential and must not be reproduced or used without the consent of EXM

Ce dessin est confidentiel et ne doit pas être reproduit ou utilisé sans le consentement de EXM

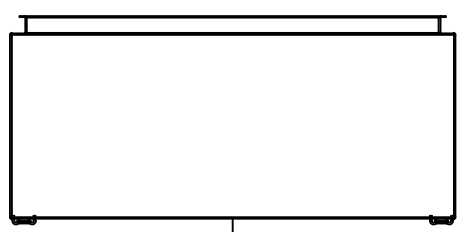

TOP

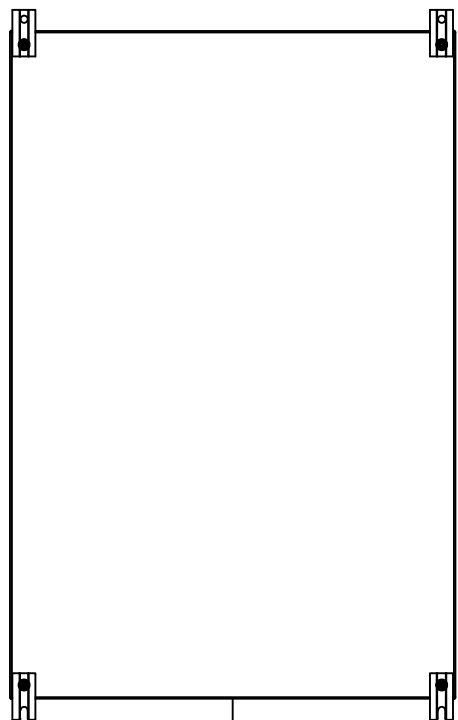

BACK

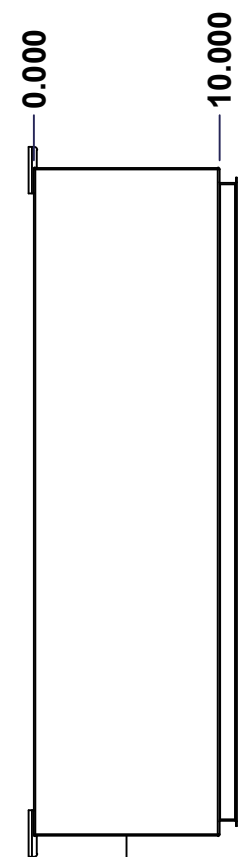

LEFT

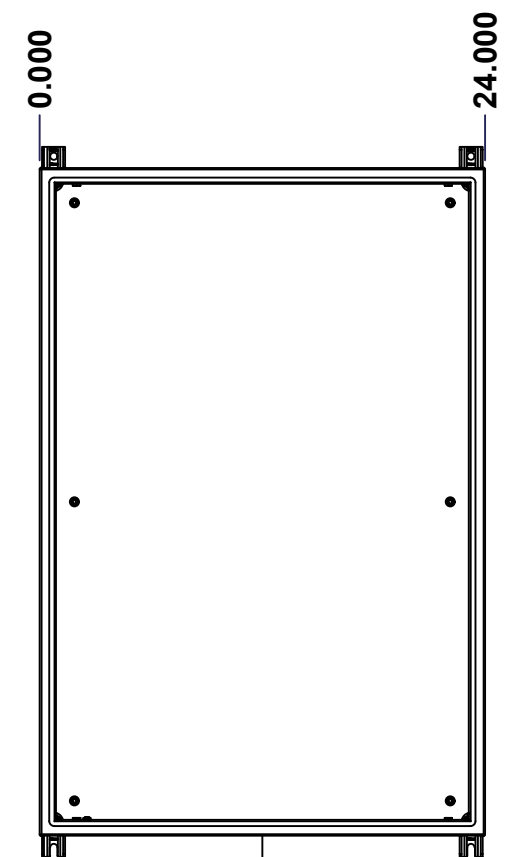

FRONT

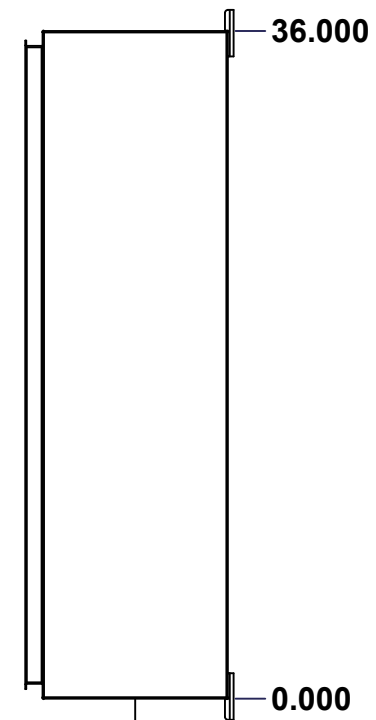

RIGHT

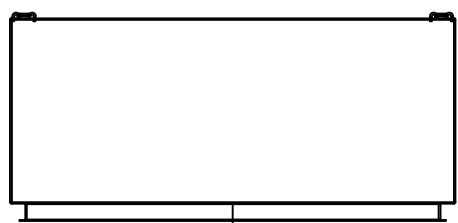

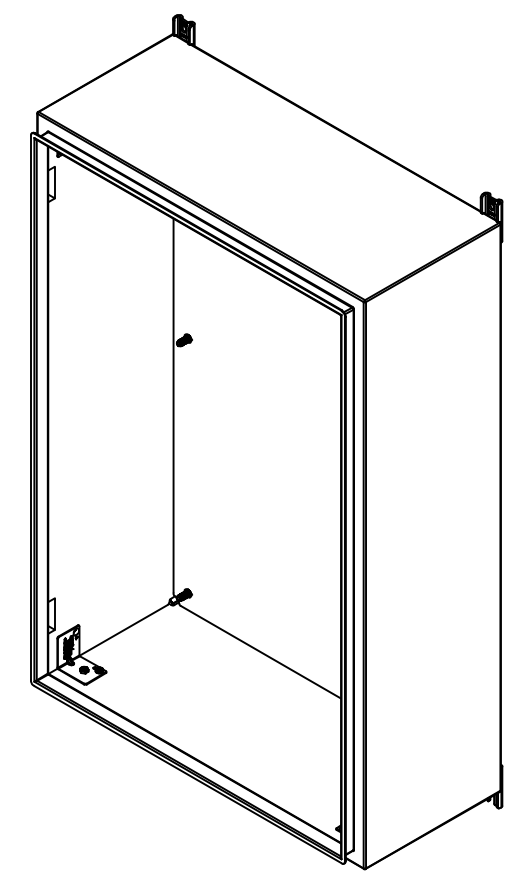

BOTTOM

No.	Revisions	Date	By/Par

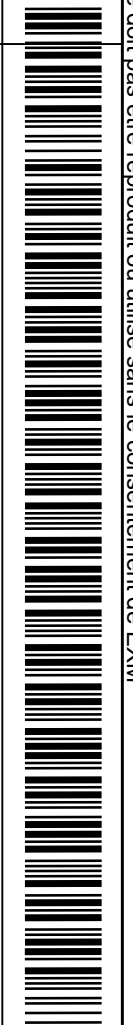

Isometric View

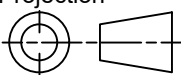

 Tél: (450) 979-4373 Fax: (450) 979-4626 <a href="http://www.exmweb.com">www.exmweb.com</a>		Flatness Aplatissement Max 3.0mm Projection 
Customer Client	Date	
Drawn By Dessiné Par	BoxCad: BoxCad	Date 13-Feb-26
Material Matière	16 Ga Stainless Steel 316 (1.4mm)	
Color Couleur	Unpainted	Finish Fini Brushed
Description	Detail Rev.	
5412ESSQT 36" x 24" x 10" Body		
Part Number Numéro Pièce	Rev. 0	3
SEE BILL OF MATERIAL ON LAST PAGE		16

SEE BILL OF MATERIAL ON LAST PAGE

**5412ESSQT3624106THB**

This drawing is confidential and must not be reproduced or used without the consent of EXM

Ce dessin est confidentiel et ne doit pas être reproduit ou utilisé sans le consentement de EXM

STANDARD FEATURES ARE NOT LISTED IN THIS HOLE TABLE			
HOLE TABLE - TOP VIEW (CUSTOM FEATURE ONLY)			
CUT-OUT	XDIM	YDIM	DESCRIPTION
1	1.500	9.250	INSUL. STUD M6 x 18mm (Inside)
2	22.500	9.250	INSUL. STUD M6 x 18mm (Inside)

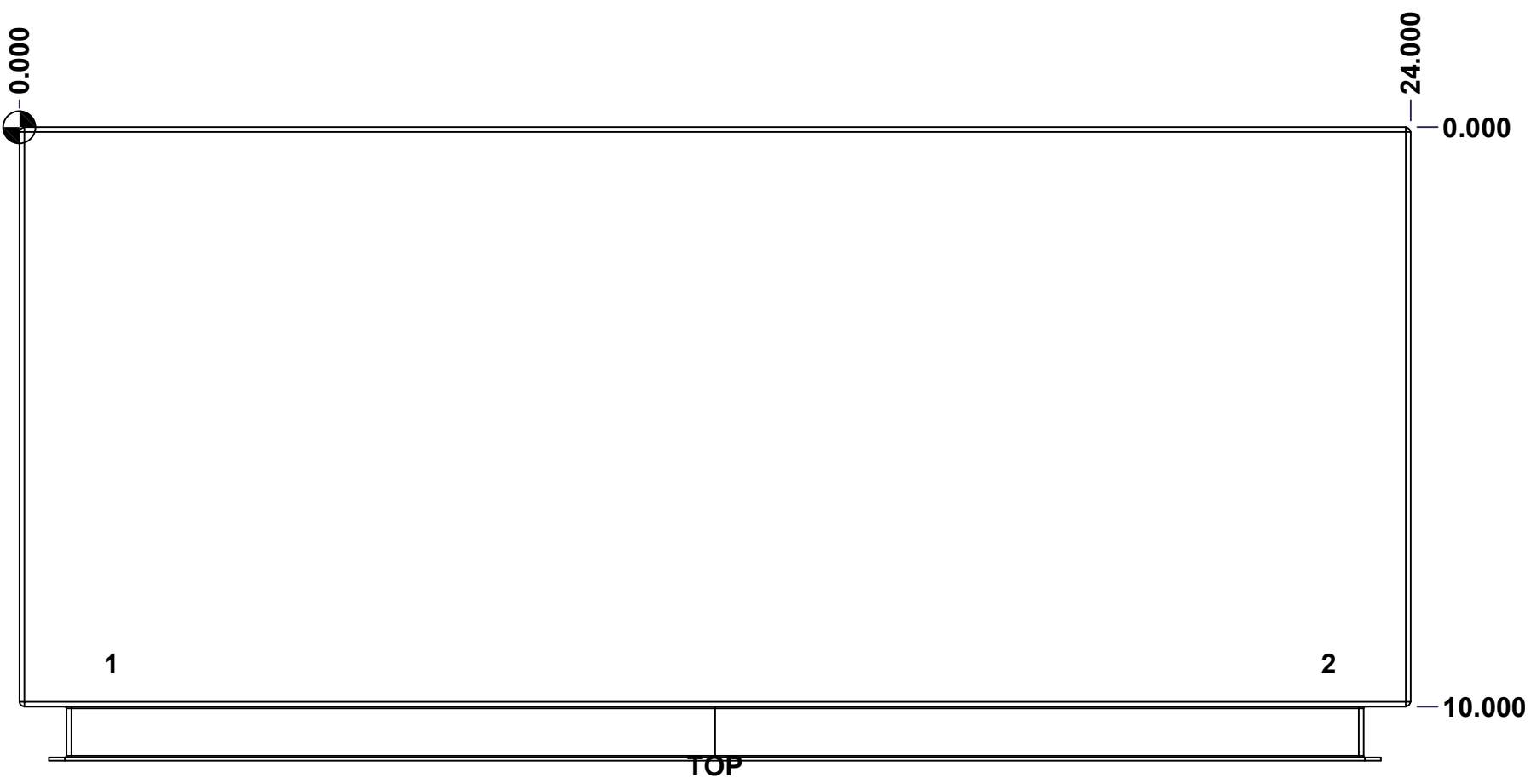

	Description	Status
	5412ESSQT 36" x 24" x 10" Body	(NULL)
	Part Number Numéro Pièce	Rev.
	<b>5412ESSQT3624106THB</b>	<b>0</b> / 4
		16

This drawing is confidential and must not be reproduced or used without the consent of EXM

Ce dessin est confidentiel et ne doit pas être reproduit ou utilisé sans le consentement de EXM

<b>STANDARD FEATURES ARE NOT LISTED IN THIS HOLE TABLE</b>			
<b>HOLE TABLE - BOTTOM VIEW (CUSTOM FEATURE ONLY)</b>			
CUT-OUT	XDIM	YDIM	DESCRIPTION
1	2.000	8.500	INSUL. STUD M6 x 18mm (Inside)
2	22.000	8.500	INSUL. STUD M6 x 18mm (Inside)

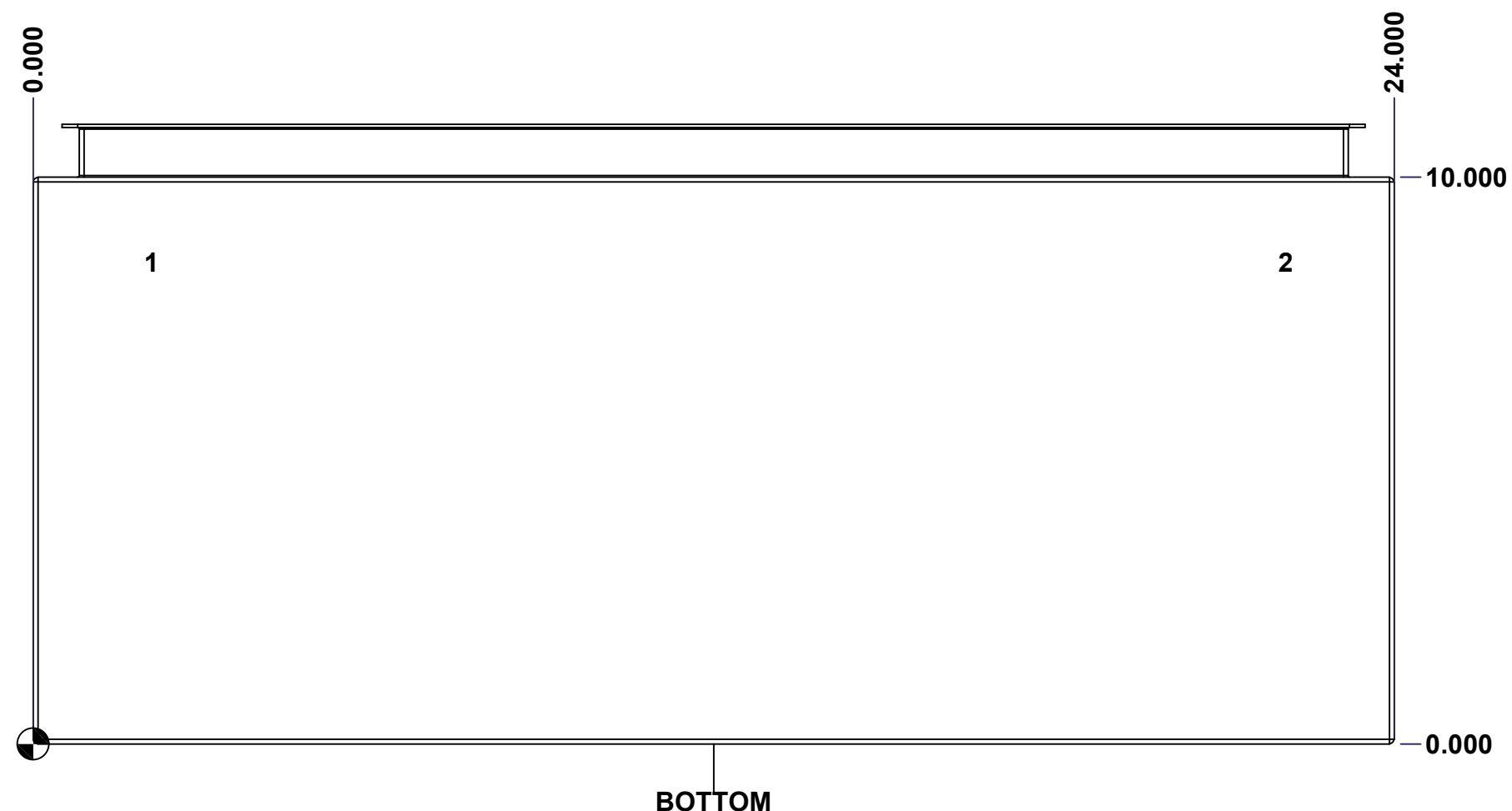

	Description	Status
	5412ESSQT 36" x 24" x 10" Body	(NULL)
	Part Number Numéro Pièce	Rev.
	<b>5412ESSQT3624106THB</b>	<b>0</b> / 5
		16

This drawing is confidential and must not be reproduced or used without the consent of EXM

Ce dessin est confidentiel et ne doit pas être reproduit ou utilisé sans le consentement de EXM

**STANDARD FEATURES ARE NOT LISTED IN THIS HOLE TABLE**

**HOLE TABLE - BACK VIEW (CUSTOM FEATURE ONLY)**

CUT-OUT	XDIM	YDIM	DESCRIPTION
1	1.875	1.875	IP STUD M8 x 35mm (Inside)
2	1.875	34.125	IP STUD M8 x 35mm (Inside)
3	22.125	34.125	IP STUD M8 x 35mm (Inside)
4	22.125	1.875	IP STUD M8 x 35mm (Inside)
5	1.875	18.000	IP STUD M8 x 35mm (Inside)
6	22.125	18.000	IP STUD M8 x 35mm (Inside)
-----			
7	0.750	0.000	FOOT 885 ESMF4_OPEN
8	0.750	36.000	FOOT 885 ESMF4_CLOSE
9	23.250	0.000	FOOT 885 ESMF4_OPEN
10	23.250	36.000	FOOT 885 ESMF4_CLOSE

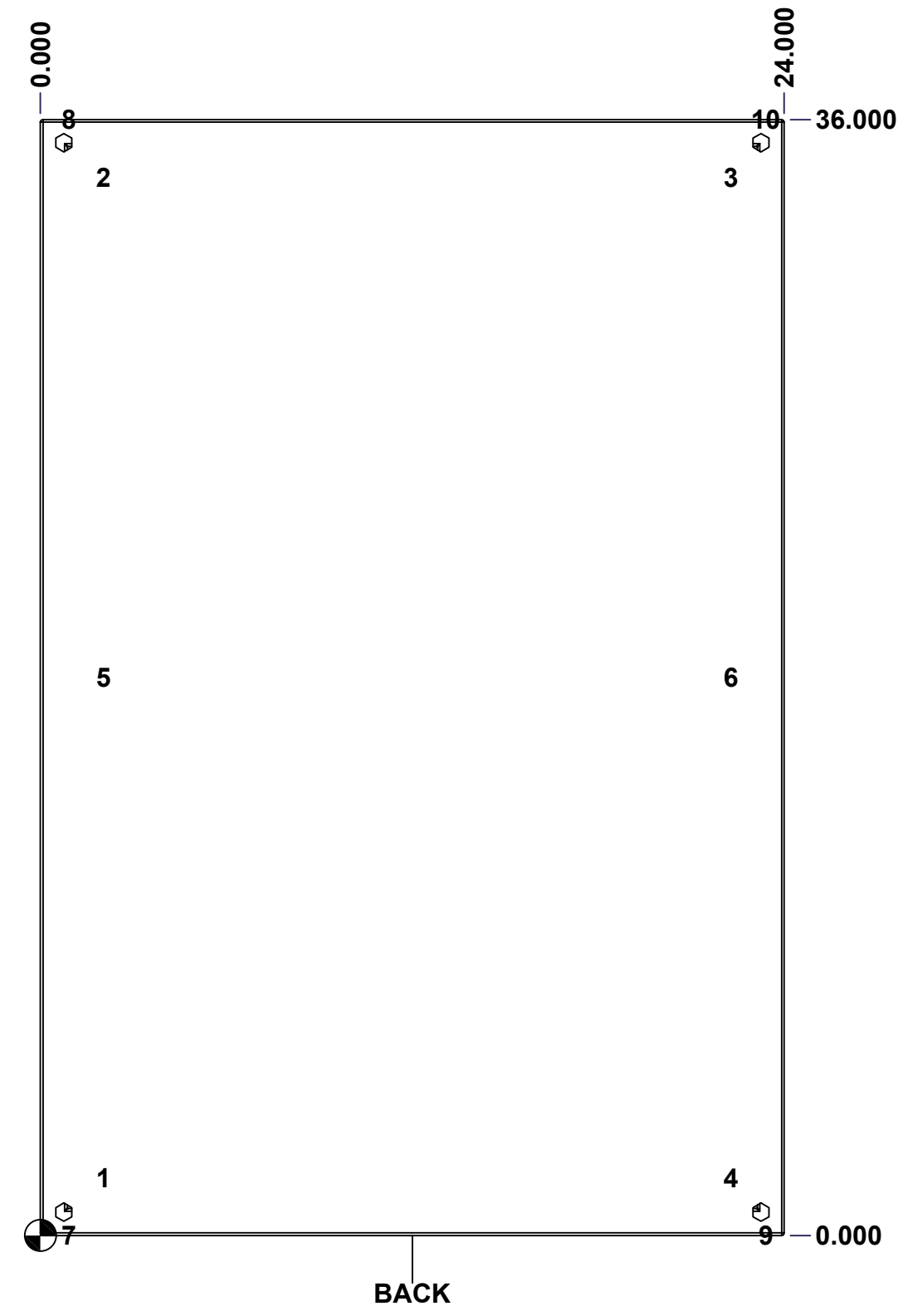

	Description	Status
	5412ESSQT 36" x 24" x 10" Body	(NULL)
	Part Number Numéro Pièce	Rev.
	<b>5412ESSQT3624106THB</b>	<b>0</b> / 6
		16

This drawing is confidential and must not be reproduced or used without the consent of EXM

Ce dessin est confidentiel et ne doit pas être reproduit ou utilisé sans le consentement de EXM

No.	Revisions	Date	By/Par

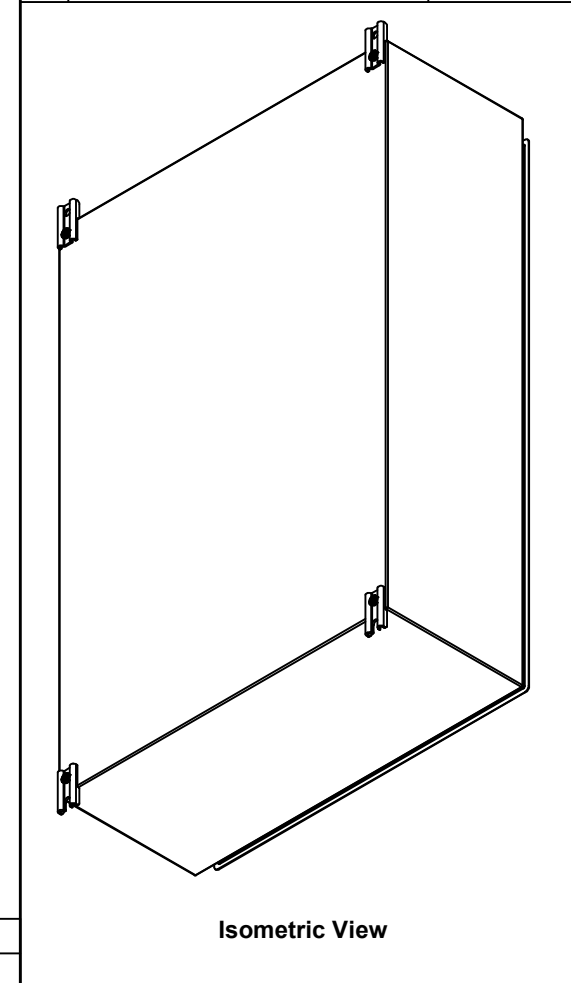

Isometric View

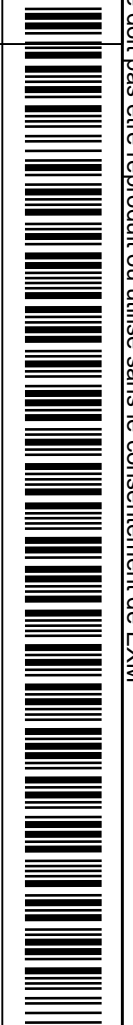

1	885 ESMF4	0	885 ESMF4 Mounting Foot Kit
1	STK-K-70554	3	5412 ESTH Accessory Kit
1	5412ESSQT3624106THI-RS	0	5412ESSQT 36" x 24" Right Insulation
1	5412ESSQT3624106THI-LS	0	5412ESSQT 36" x 24" Left Insulation
1	5412ESSQT3624106THI-BT	0	5412ESSQT 36" x 24"Bottom Insulation
1	5412ESSQT3624106THI-TP	0	5412ESSQT 36" x 24"Top Insulation
1	5412ESSQT3624106THI-B	0	5412ESSQT 36" x 24" Back Insulation
4	STK-Q-16070	1	Stud M6 x 18mm Stainless steel
4	RIVET_NUT_SS_M10_FH_CE	0	Stainless Steel Rivet Nut M10 (Low Profile Close End)
6	STK-Q-16020	1	Stud M8 x 35mm Stainless Steel
1	5412ESSQT3624106THB-P	0	5412ESSQT 36" x 24" x 10" Body Part
Qty	Part Number	Rev	Description
Parts List			

<p>Tél: (450) 979-4373 Fax: (450) 979-4626 <a href="http://www.exmweb.com">www.exmweb.com</a></p>	Flatness Aplatissement	Max 3.0mm
	Projection	
Customer Client	Date	
Drawn By Dessiné Par	BoxCad: BoxCad	Date 13-Feb-26
Material Matière	16 Ga Stainless Steel 316 (1.4mm)	
Color Couleur	Unpainted	Finish Fini Brushed
Description	Detail Rev.	
5412ESSQT 36" x 24" x 10" Body		
Part Number Numéro Pièce	Rev.	7
<b>5412ESSQT3624106THB</b>	<b>0</b>	16

This drawing is confidential and must not be reproduced or used without the consent of EXM

Ce dessin est confidentiel et ne doit pas être reproduit ou utilisé sans le consentement de EXM

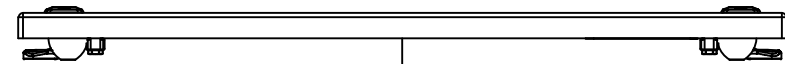

TOP

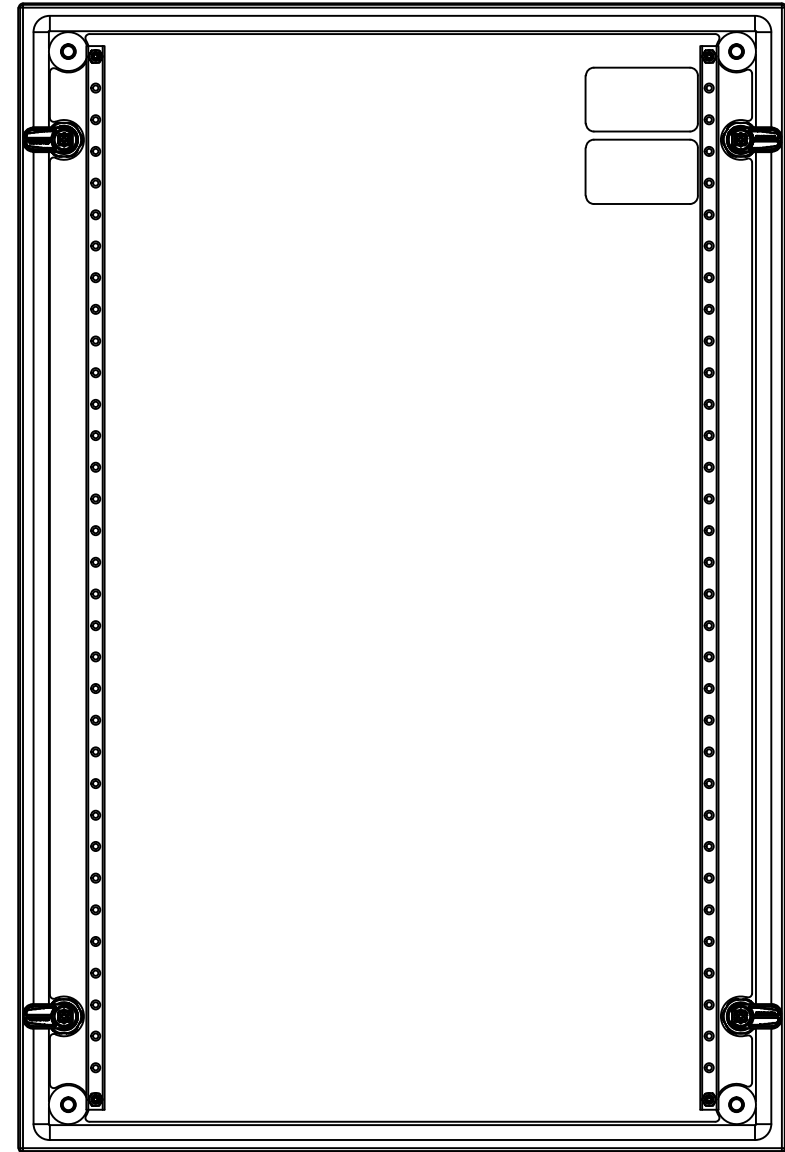

BACK

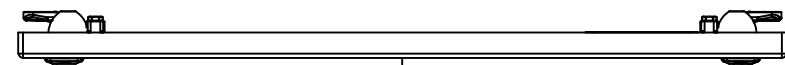

BOTTOM

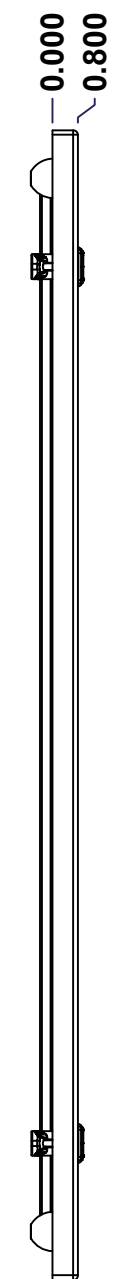

LEFT

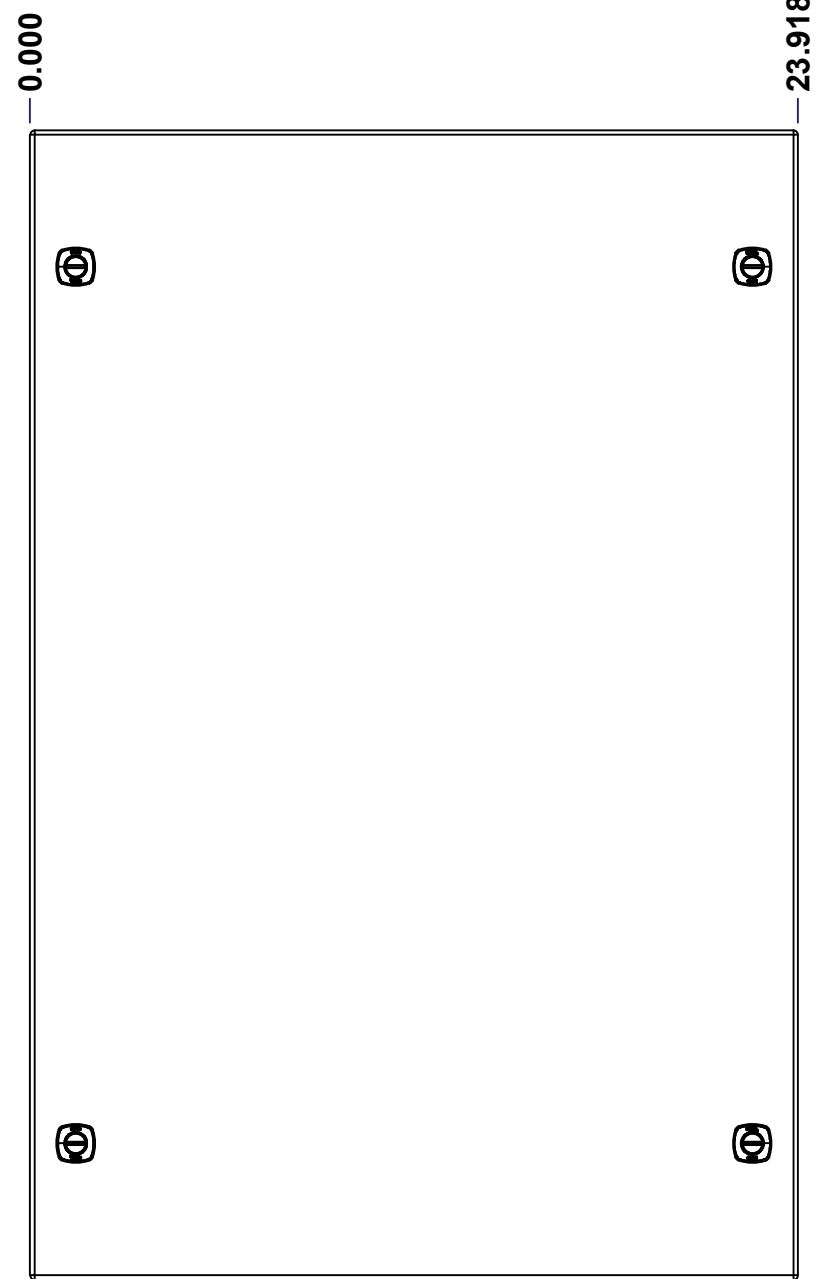

FRONT

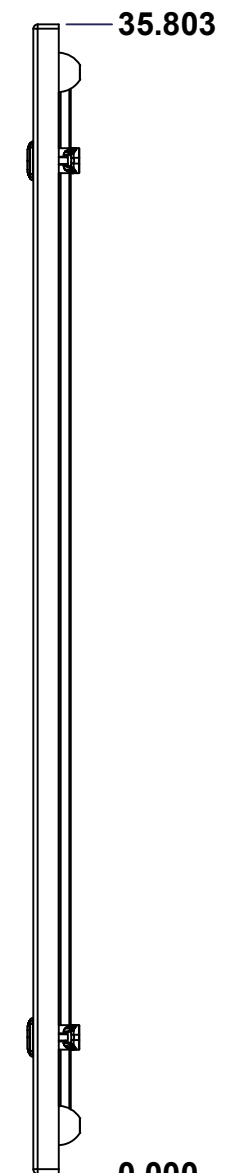

RIGHT

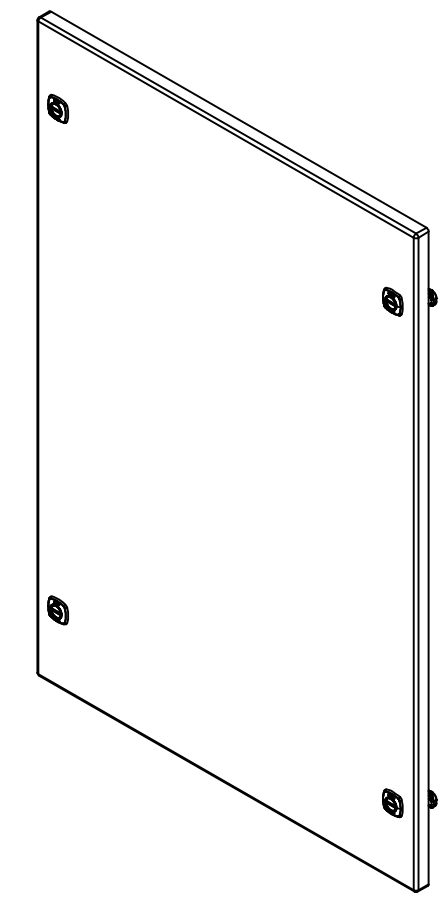

Isometric View

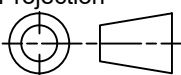

No.	Revisions	Date	By/Par

 Tél: (450) 979-4373 Fax: (450) 979-4626 <a href="http://www.exmweb.com">www.exmweb.com</a>		Flatness Aplatissement Max 3.0mm Projection 
Customer Client	Date	
Drawn By Dessiné Par	BoxCad: BoxCad	Date 13-Feb-26
Material Matière	16 Ga Stainless Steel 316 (1.4mm)	
Color Couleur	Unpainted	Finish Fini Brushed
Description 5412ESSQT 36" x 24" Cover		Detail Rev.
Part Number Numéro Pièce	Rev. 0	8 / 16

SEE BILL OF MATERIAL ON LAST PAGE

**5412ESSQT3624106THC**

This drawing is confidential and must not be reproduced or used without the consent of EXM

Ce dessin est confidentiel et ne doit pas être reproduit ou utilisé sans le consentement de EXM

**STANDARD FEATURES ARE NOT LISTED IN THIS HOLE TABLE**

**HOLE TABLE - FRONT VIEW (CUSTOM FEATURE ONLY)**

CUT-OUT	XDIM	YDIM	DESCRIPTION
1	2.401	1.661	STUD M6 x 18mm (Inside)
2	2.401	34.142	STUD M6 x 18mm (Inside)
3	21.517	34.142	STUD M6 x 18mm (Inside)
4	21.517	1.661	STUD M6 x 18mm (Inside)
5	1.550	1.500	STUD M6 x 18mm (Inside)
6	22.368	1.500	STUD M6 x 18mm (Inside)
7	1.550	34.303	STUD M6 x 18mm (Inside)
8	22.368	34.303	STUD M6 x 18mm (Inside)
-----			
9	1.424	4.250	LOCK 880 SCQ4-SLSS6 @ 180.0°
10	1.424	31.553	LOCK 880 SCQ4-SLSS6 @ 180.0°
11	22.494	4.250	LOCK 880 SCQ4-SLSS6 @ 0.0°
12	22.494	31.553	LOCK 880 SCQ4-SLSS6 @ 0.0°

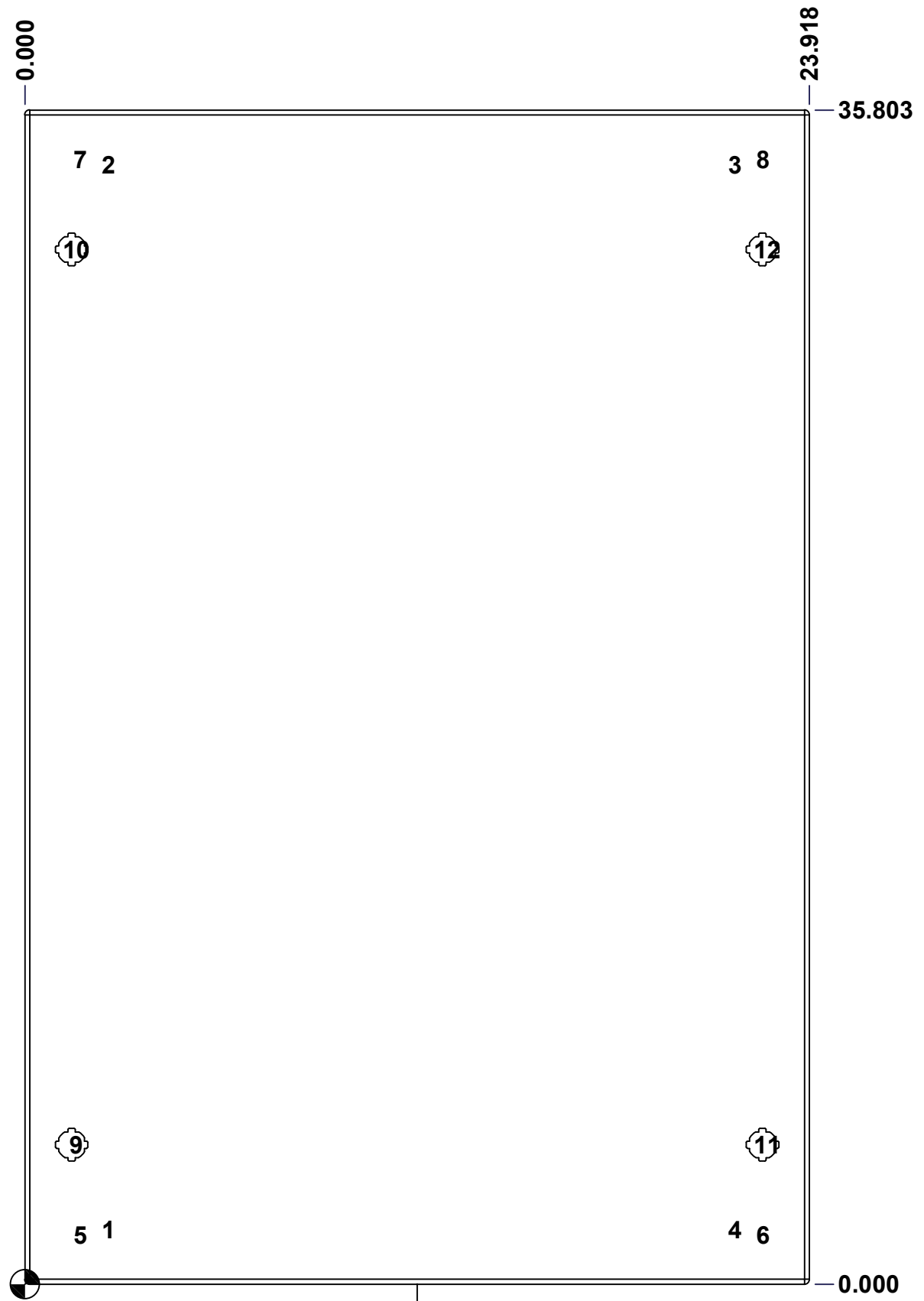

FRONT

	Description	Status
	5412ESSQT 36" x 24" Cover	(NULL)
	Part Number Numéro Pièce	Rev.
	<b>5412ESSQT3624106THC</b>	<b>0</b> / 9
		16

This drawing is confidential and must not be reproduced or used without the consent of EXM

Ce dessin est confidentiel et ne doit pas être reproduit ou utilisé sans le consentement de EXM

No.	Revisions	Date	By/Par

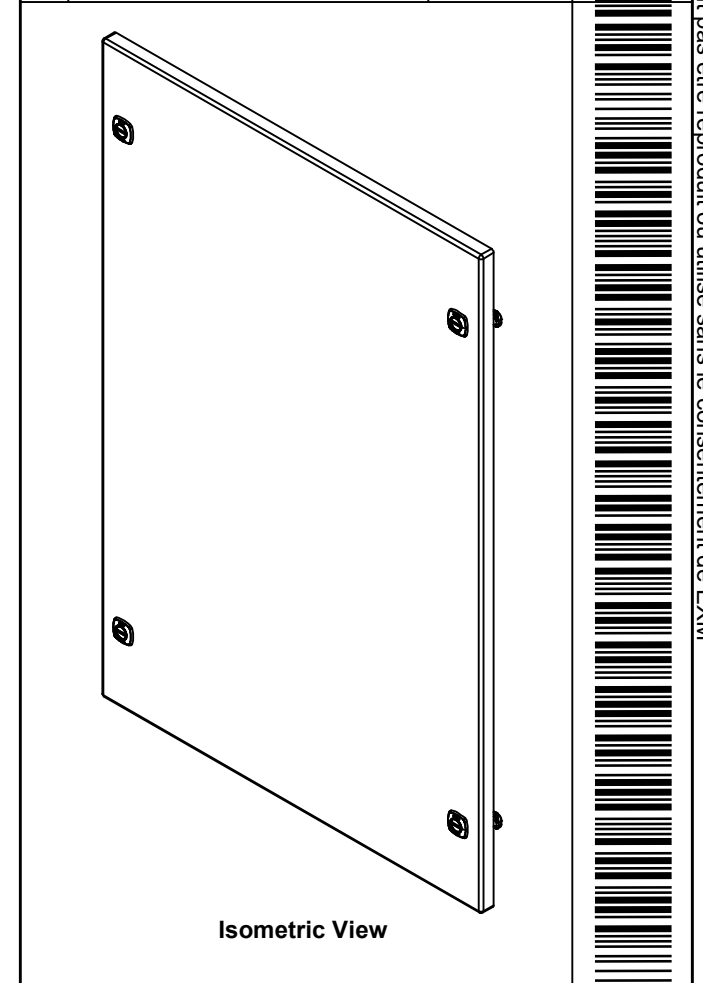

 Tél: (450) 979-4373  
 Fax: (450) 979-4626  
[www.exmweb.com](http://www.exmweb.com)

Flatness / Aplatissement: Max 3.0mm  
 Projection: 

QTY	Part Number	Rev	Description
4	STK-Q-07250	2	M6 x 16mm Collar Nut
2	STK-Q-46020-36	5	5412 ES Vertical Door Stiffener 36"
2	STK-S-00100	0	3.5" x 2" Silver Milar Flexcon Sticker
1	5412ESSQT3624106THI-C	0	5412ESSQT 36" x 24" Cover Insulation
4	STK-K-12590	7	5412 ESS 1/4 Turn Lock
8	STK-Q-16070	1	Stud M6 x 18mm Stainless steel
1	5412ESSQT3624106THG	0	5412ESSQT 36" x 24" Cover Gasket Part
1	5412ESSQT3624106THC-P	0	5412ESSQT 36" x 24" Cover Part
4	STK-Q-46515	3	5412 ES Door Support with Brass Insert
Parts List			

Customer Client	Date
Drawn By / Dessiné Par: BoxCad: BoxCad	Date: 13-Feb-26
Material / Matière: 16 Ga Stainless Steel 316 (1.4mm)	
Color / Couleur: Unpainted	Finish / Fini: Brushed
Description: 5412ESSQT 36" x 24" Cover	Detail Rev.
Part Number / Numéro Pièce: <b>5412ESSQT3624106THC</b>	Rev. 0
	10 / 16

This drawing is confidential and must not be reproduced or used without the consent of EXM

Ce dessin est confidentiel et ne doit pas être reproduit ou utilisé sans le consentement de EXM

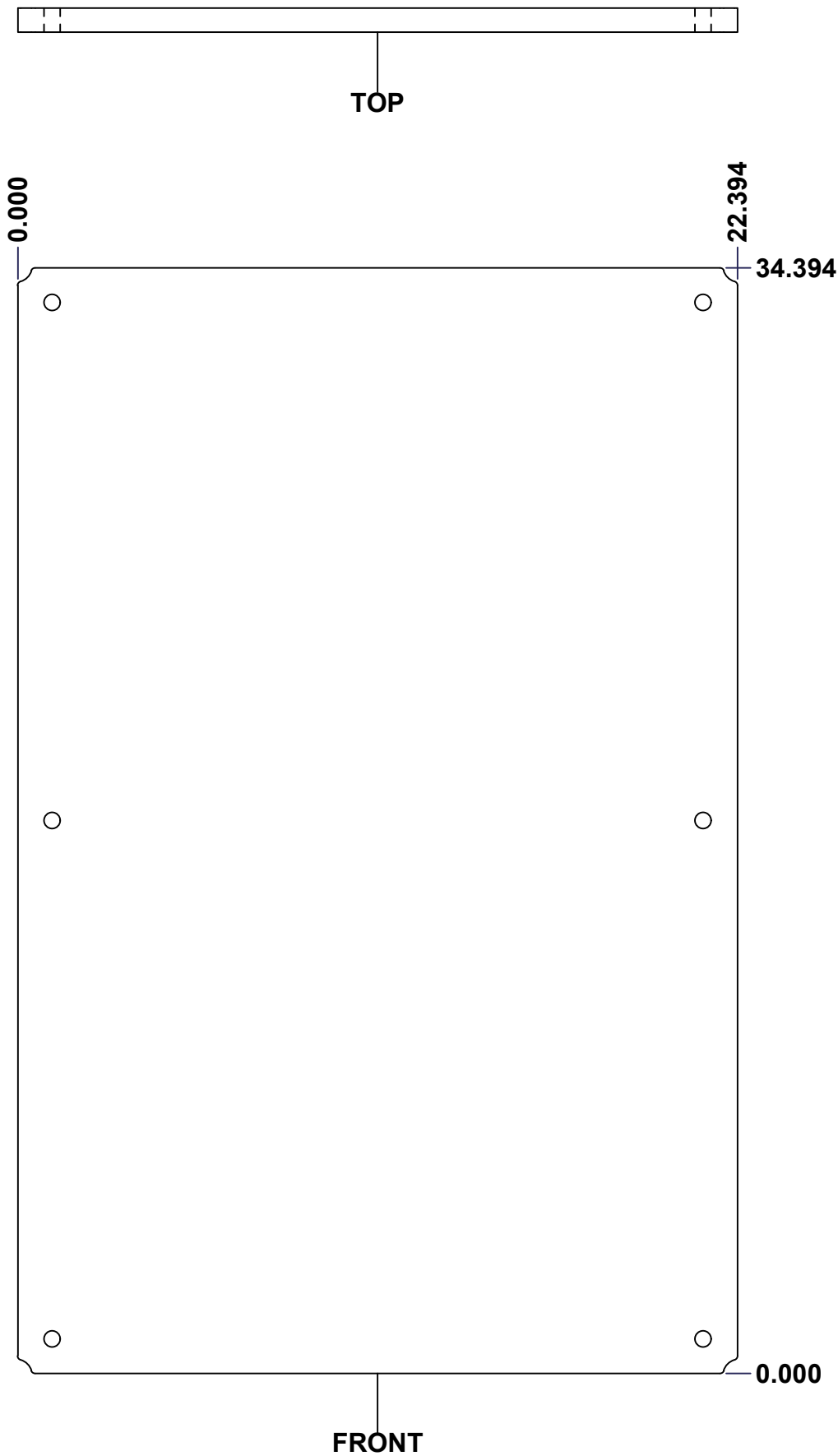

No.	Revisions	Date	By/Par

**Isometric View**

<p>Tél: (450) 979-4373                  Fax: (450) 979-4626  <a href="http://www.exmweb.com">www.exmweb.com</a></p>		Flatness Aplatissement	
		Max 3.0mm	
Customer Client		Date	
Drawn By Dessiné Par		Date	
Material Matière		Polyisocyanurate	
Color Couleur		Aluminum	Finish Fini
Description		Detail Rev.	
Part Number Numéro Pièce		Rev.	11
5412ESSQT3624106THI-B		0	16

SEE BILL OF MATERIAL ON LAST PAGE

This drawing is confidential and must not be reproduced or used without the consent of EXM

Ce dessin est confidentiel et ne doit pas être reproduit ou utilisé sans le consentement de EXM

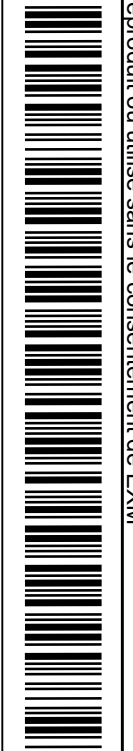
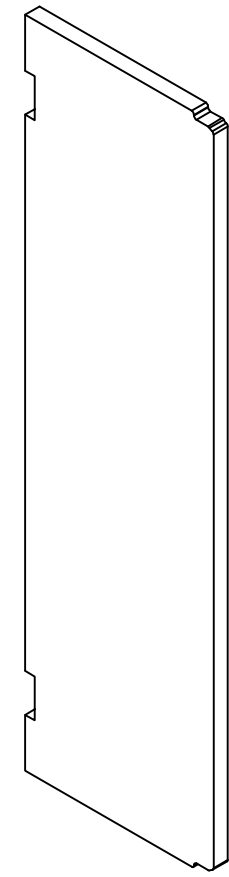
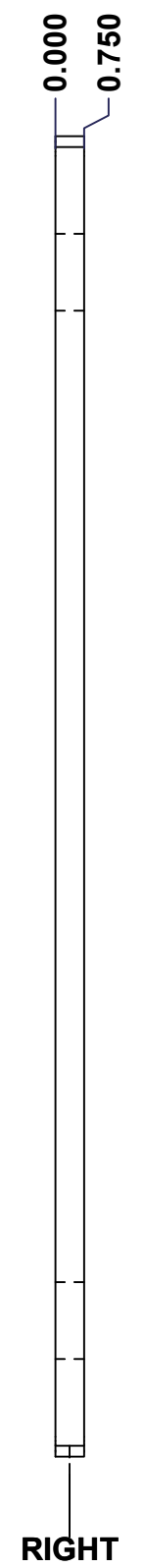
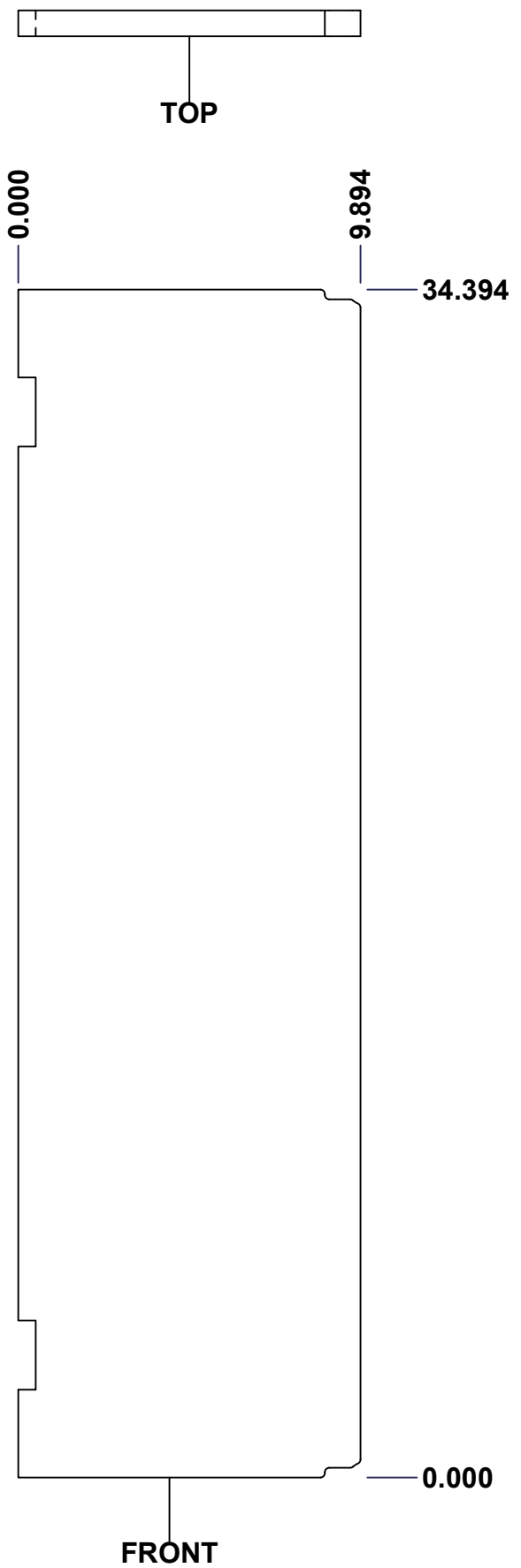

No.	Revisions	Date	By/Par

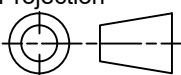
 Tél: (450) 979-4373 Fax: (450) 979-4626 <a href="http://www.exmweb.com">www.exmweb.com</a>		Flatness Aplatissement Max 3.0mm
Customer Client		Projection 
Drawn By / Dessiné Par: BoxCad: Patrick Deschenes		Date: 23-Jan-07
Material / Matière: Polyisocyanurate		
Color / Couleur: Aluminum	Finish / Fini: N/A	
Description: 5412ESSQT 36" x 24" Left Insulation		Detail Rev.
Part Number / Numéro Pièce: 5412ESSQT3624106TH-LS		Rev. 12 / 16

SEE BILL OF MATERIAL ON LAST PAGE

This drawing is confidential and must not be reproduced or used without the consent of EXM

Ce dessin est confidentiel et ne doit pas être reproduit ou utilisé sans le consentement de EXM

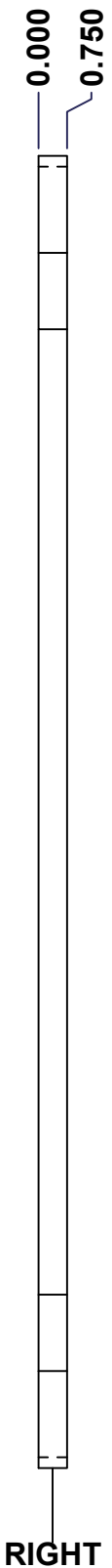
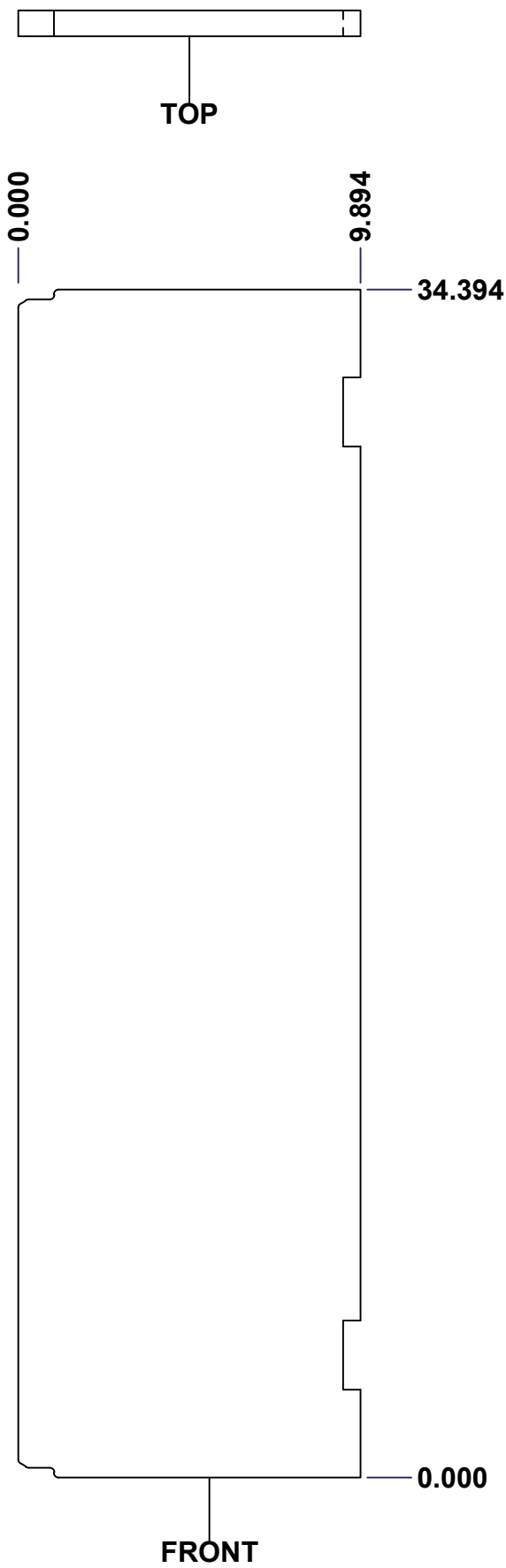

No.	Revisions	Date	By/Par

Isometric View

<p>Tél: (450) 979-4373 Fax: (450) 979-4626 <a href="http://www.exmweb.com">www.exmweb.com</a></p>		Flatness Aplatissement	
		Max 3.0mm	
Customer Client		Date	
Drawn By Dessiné Par		Date 23-Jan-07	
Material Matière		Polyisocyanurate	
Color Couleur	Aluminum	Finish Fini	N/A
Description			Detail Rev.
5412ESSQT 36" x 24" Right Insulation			
Part Number Numéro Pièce		Rev.	13
5412ESSQT3624106THI-RS		0	16

SEE BILL OF MATERIAL ON LAST PAGE

This drawing is confidential and must not be reproduced or used without the consent of EXM

Ce dessin est confidentiel et ne doit pas être reproduit ou utilisé sans le consentement de EXM

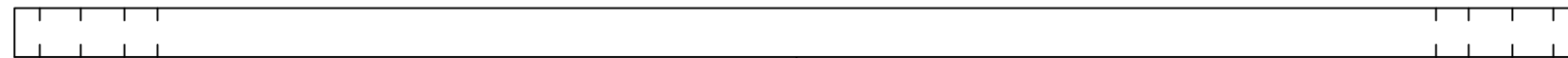

TOP

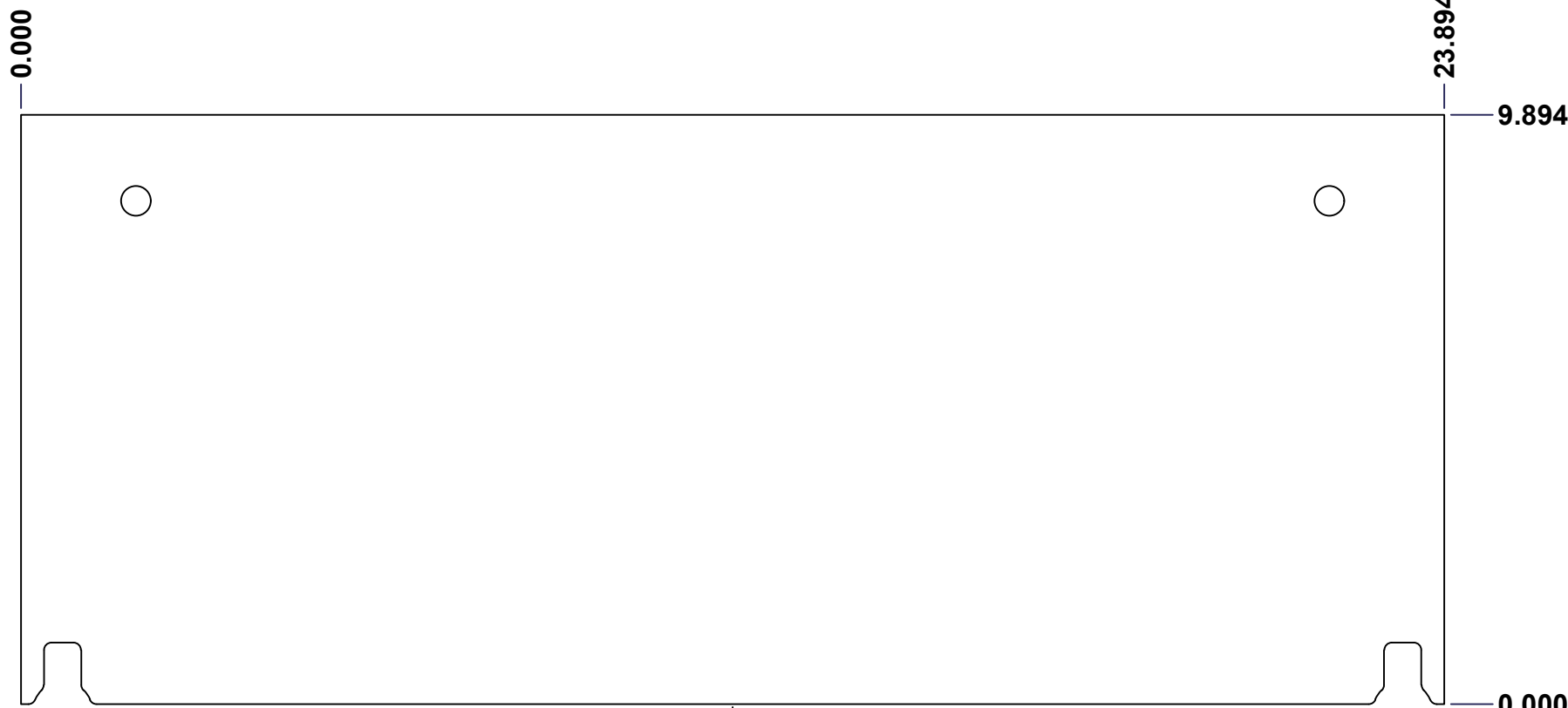

FRONT

0.000  
0.750

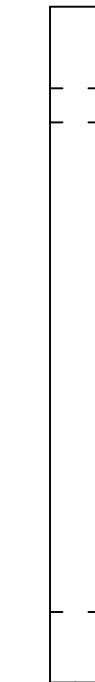

RIGHT

No.	Revisions	Date	By/Par

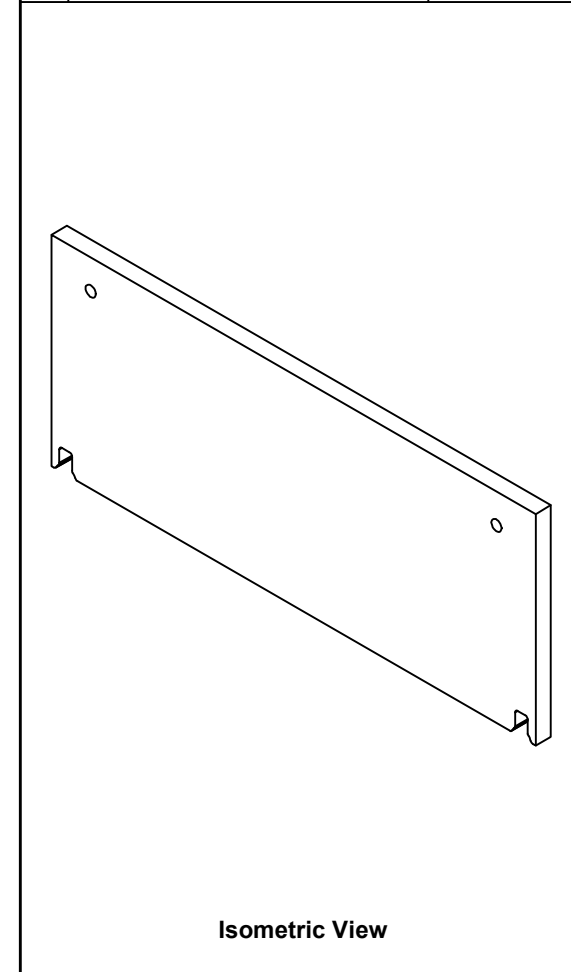

Isometric View

**EXM**  
exm

Tél: (450) 979-4373  
Fax: (450) 979-4626  
[www.exmweb.com](http://www.exmweb.com)

Flatness  
Aplatissement  
Max 5.0mm  
Projection

Customer Client	Date
Drawn By Dessiné Par BoxCad: BoxCad	Date 4/3/2024
Material Matière Polyisocyanurate	
Color Couleur Aluminum	Finish Fini Brushed
Description 5412ESSQT 36" x 24"Top Insulation	Detail Rev.
Part Number Numéro Pièce <b>5412ESSQT3624106THI-TP</b>	Rev. <b>0</b>

SEE BILL OF MATERIAL ON LAST PAGE

This drawing is confidential and must not be reproduced or used without the consent of EXM

Ce dessin est confidentiel et ne doit pas être reproduit ou utilisé sans le consentement de EXM

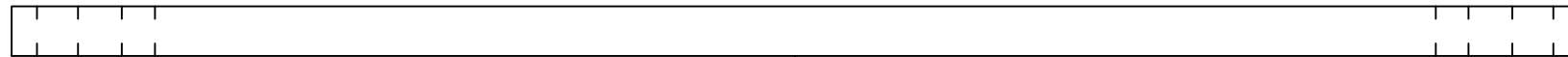

TOP

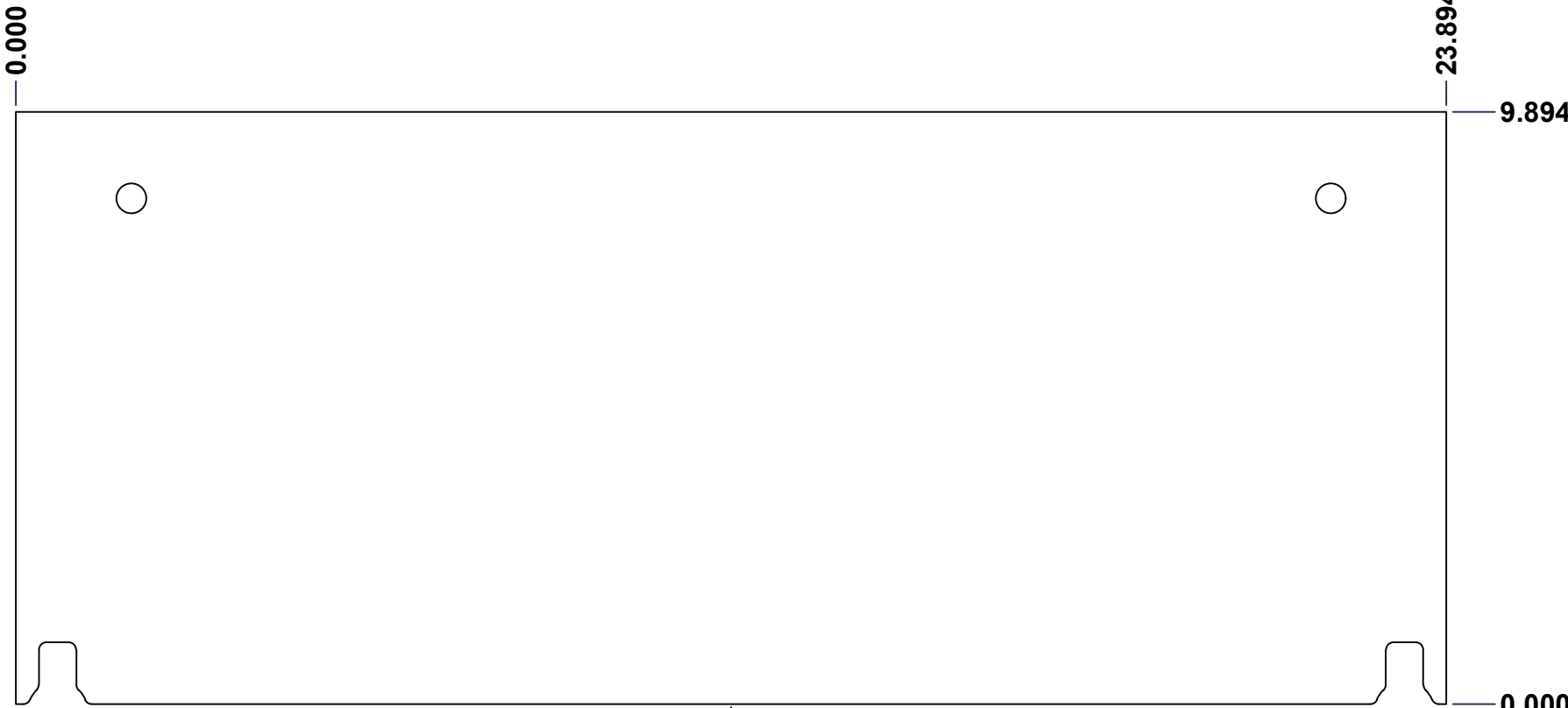

FRONT

0.000  
0.750

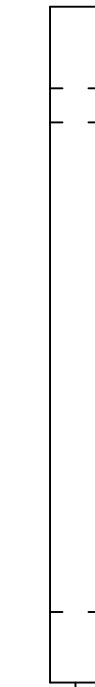

RIGHT

No.	Revisions	Date	By/Par

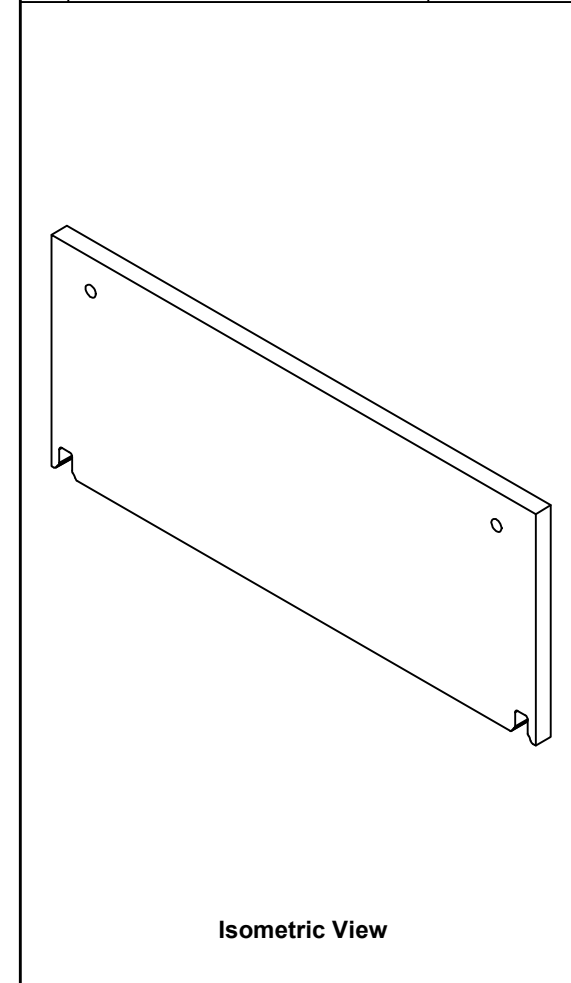

Isometric View

 Tél: (450) 979-4373  
 Fax: (450) 979-4626  
[www.exmweb.com](http://www.exmweb.com)

Flatness / Aplatissement: Max 5.0mm  
 Projection: 

Customer Client	Date
Drawn By / Dessiné Par: BoxCad: BoxCad	Date: 4/3/2024
Material / Matière: Polyisocyanurate	
Color / Couleur: Aluminum	Finish / Fini: Brushed
Description: 5412ESSQT 36" x 24"Bottom Insulation	Detail Rev.
Part Number / Numéro Pièce: 5412ESSQT3624106THI-BT	Rev. 15
SEE BILL OF MATERIAL ON LAST PAGE	0

SEE BILL OF MATERIAL ON LAST PAGE 5412ESSQT3624106THI-BT 0 16

This drawing is confidential and must not be reproduced or used without the consent of EXM

Ce dessin est confidentiel et ne doit pas être reproduit ou utilisé sans le consentement de EXM

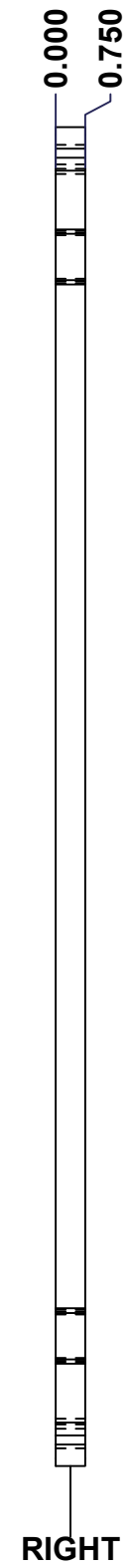
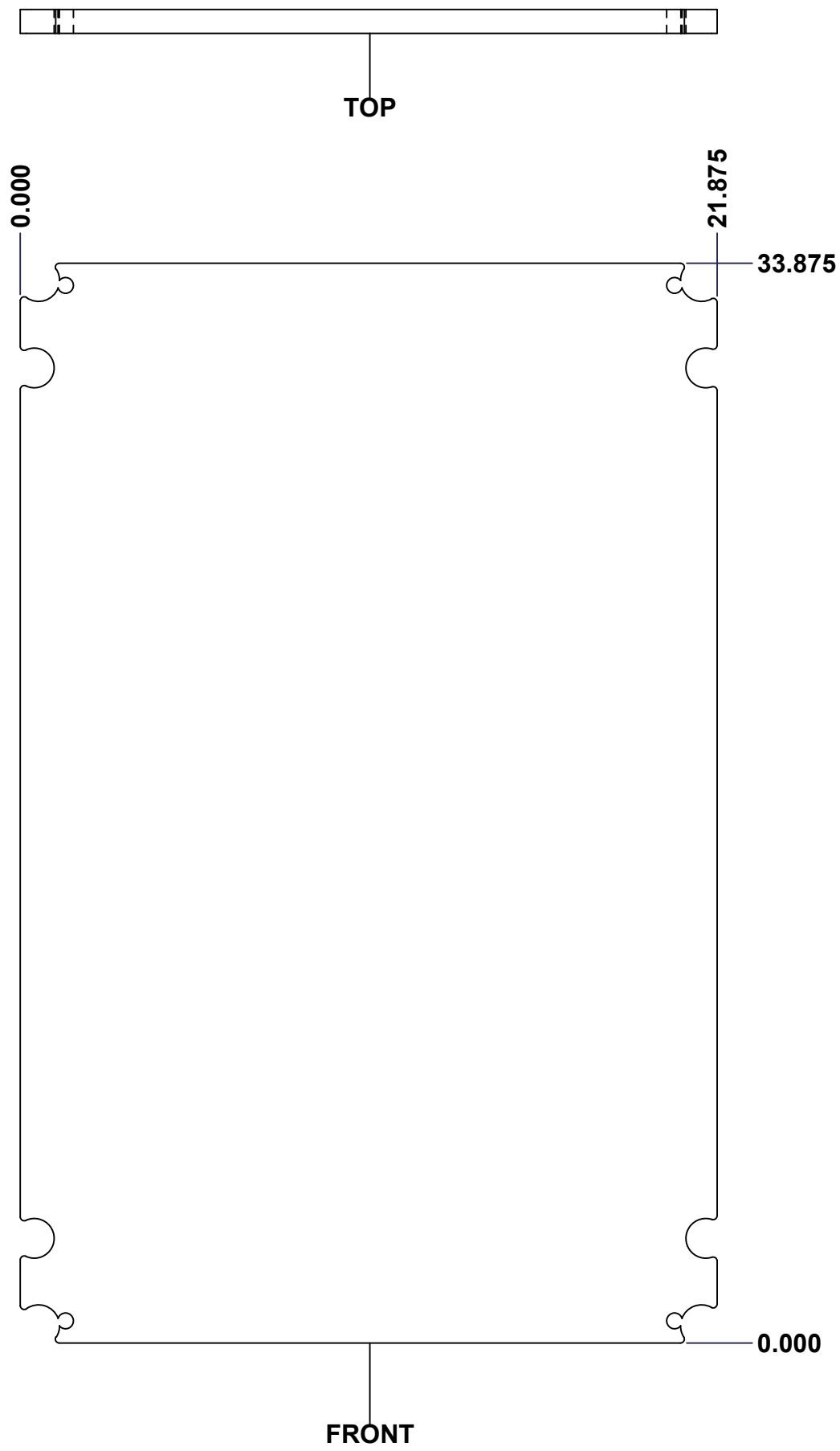

No.	Revisions	Date	By/Par

**Isometric View**

<p>Tél: (450) 979-4373 Fax: (450) 979-4626 <a href="http://www.exmweb.com">www.exmweb.com</a></p>		Flatness Aplatissement
		Max 3.0mm
		Projection
Customer Client	Date	
Drawn By Dessiné Par	BoxCad: Patrick Deschenes	Date 23-Jan-07
Material Matière	Polyisocyanurate	
Color Couleur	Aluminum	Finish Fini N/A
Description	Detail Rev.	
5412ESSQT 36" x 24" Cover Insulation		
Part Number Numéro Pièce	Rev. 0	16
5412ESSQT3624106THI-C		16

SEE BILL OF MATERIAL ON LAST PAGE

This drawing is confidential and must not be reproduced or used without the consent of EXM

Ce dessin est confidentiel et ne doit pas être reproduit ou utilisé sans le consentement de EXM



No.	Revisions	Date	By/Par

Isometric View

Tél: (450) 979-4373 Fax: (450) 979-4626 www.exmweb.com		Flatness Aplatissement Max 3.0mm Projection 
Customer Client	Date	
Drawn By Dessiné Par	BoxCad	Date 23-Jan-07
Material Matière	See Part List	
Color Couleur	See Part List	Finish Fini See Part List
Description	Detail Rev.	
881 SP - Inner Panel		
Part Number Numéro Pièce	Rev. 0	1 2

Qty	Part Number	Rev	Description	Material	Color	Finish
1	881 SP3624G-P	0	881 SP - Inner Panel Part	12 Ga Galvanized	Unpainted	Galvanized

Parts List

This drawing is confidential and must not be reproduced or used without the consent of EXM

Ce dessin est confidentiel et ne doit pas être reproduit ou utilisé sans le consentement de EXM

Table 1			FRONT VIEW
CUT-OUT	XDIM	YDIM	DESCRIPTION
1	0.875	1.875	GROUND HOLE (RND Ø0.290)
2	21.125	1.875	GROUND HOLE (RND Ø0.290)
3	0.875	32.125	GROUND HOLE (RND Ø0.290)
4	21.125	32.125	GROUND HOLE (RND Ø0.290)
5	0.875	17.000	MTG STUD HOLE (RND Ø0.500)
6	21.125	17.000	MTG STUD HOLE (RND Ø0.500)

All knockouts are actual size / Les disques défonçables sont grandeur réel



No.	Revisions	Date	By/Par

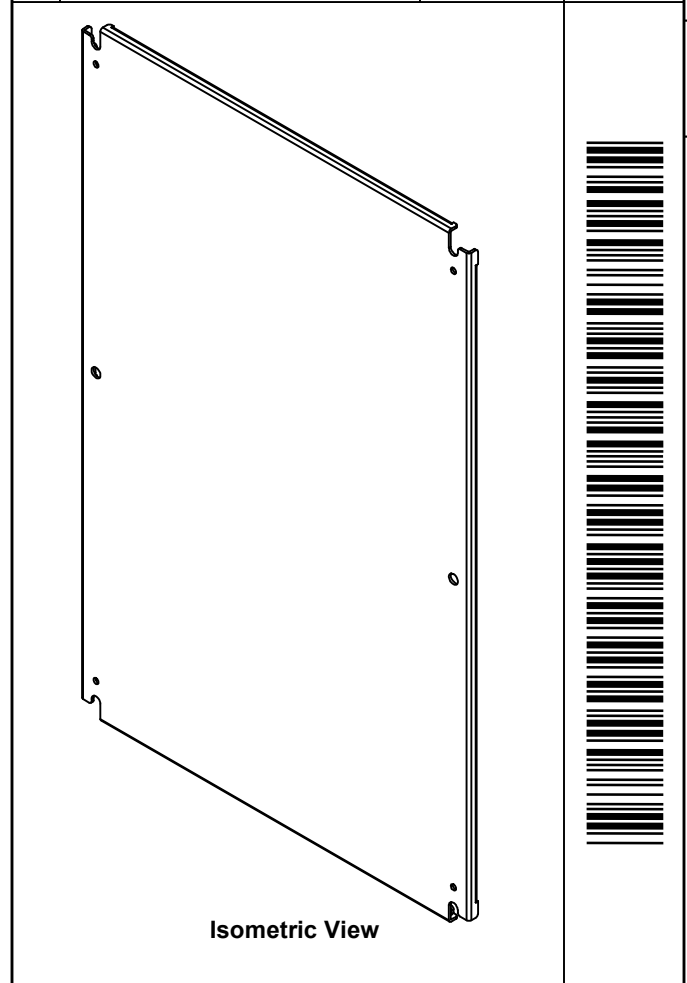

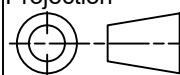
 Tél: (450) 979-4373 Fax: (450) 979-4626 www.exmweb.com		Flatness Aplatissement Max 3.0mm Projection 
Customer Client	Date	
Drawn By Dessiné Par	BoxCad	Date 23-Jan-07
Material Matière	See Part List	
Color Couleur	See Part List	Finish Fini See Part List
Description	Detail Rev.	
881 SP - Inner Panel		
Part Number Numéro Pièce	Rev.	2
881 SP3624G	0	2