

This drawing is confidential and must not be reproduced or used without the consent of EXM

Ce dessin est confidentiel et ne doit pas être reproduit ou utilisé sans le consentement de EXM

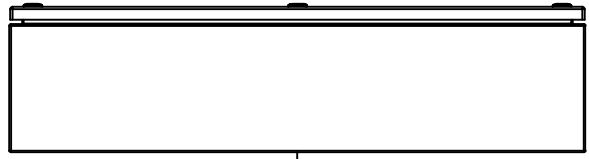

TOP

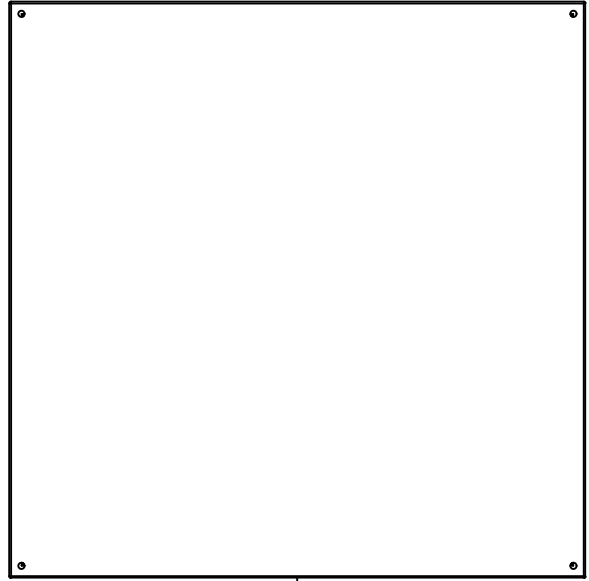

BACK

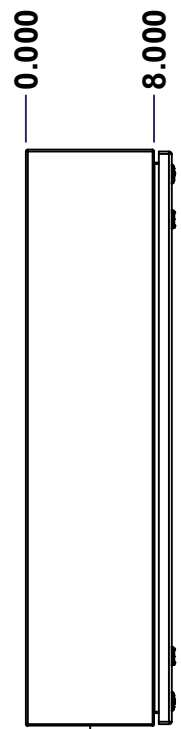

LEFT

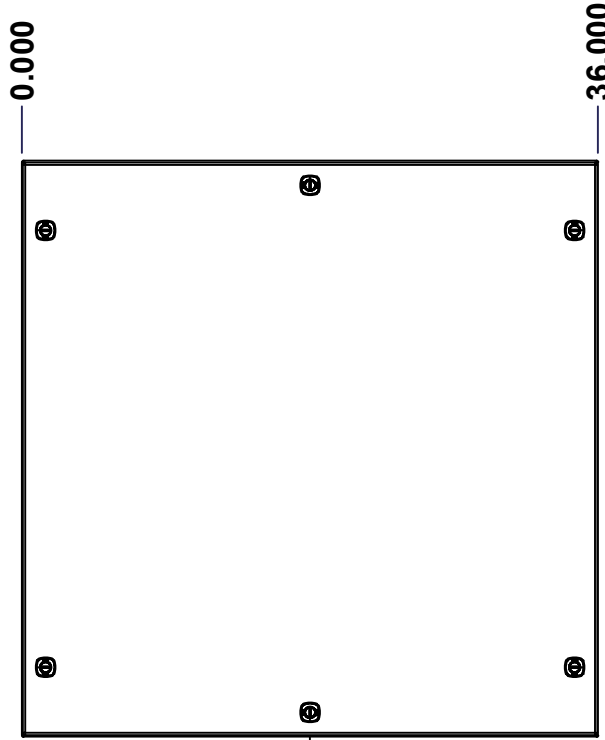

FRONT

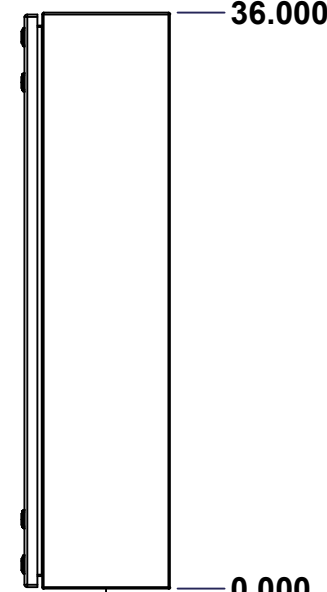

RIGHT

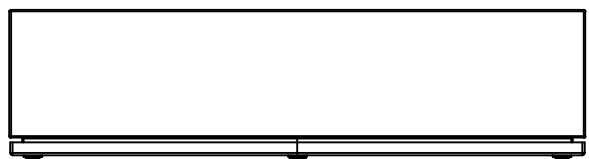

BOTTOM

**GRAIN DIRECTION:  
TOP/BOTTOM: HORIZONTAL  
LEFT/RIGHT/BACK/FRONT: VERTICAL**

No.	Revisions	Date	By/Par

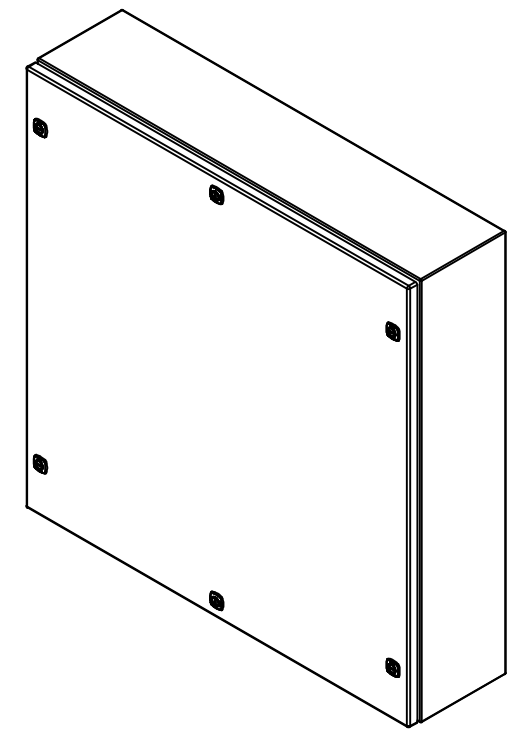

Isometric View



Tél: (450) 979-4373 Fax: (450) 979-4626 <a href="http://www.exmweb.com">www.exmweb.com</a>	Flatness Aplatissement	Max 3.0mm
	Projection	
Customer Client	Date	
Drawn By Dessiné Par	BoxCad: BoxCad	Date 02-Feb-26
Material Matière	14 Ga Stainless Steel 316 (1.7mm)	
Color Couleur	Unpainted	Finish Fini Brushed
Description	Detail Rev.	
5412ESSQT 36" x 36" x 8" Assembly		
Part Number Numéro Pièce	Rev.	1
5412ESSQT3636086	0	9

SEE BILL OF MATERIAL ON LAST PAGE

This drawing is confidential and must not be reproduced or used without the consent of EXM

Ce dessin est confidentiel et ne doit pas être reproduit ou utilisé sans le consentement de EXM

NOTE	
ITEM	DESCRIPTION
1	NEMA 4X Enclosure (IP66)
2	C/W Standard ground studs on box and cover
3	C/W Standard door stiffener
4	C/W Standard inner panel (Included)
5	C/W Standard inner panel mounting studs

No.	Revisions	Date	By/Par

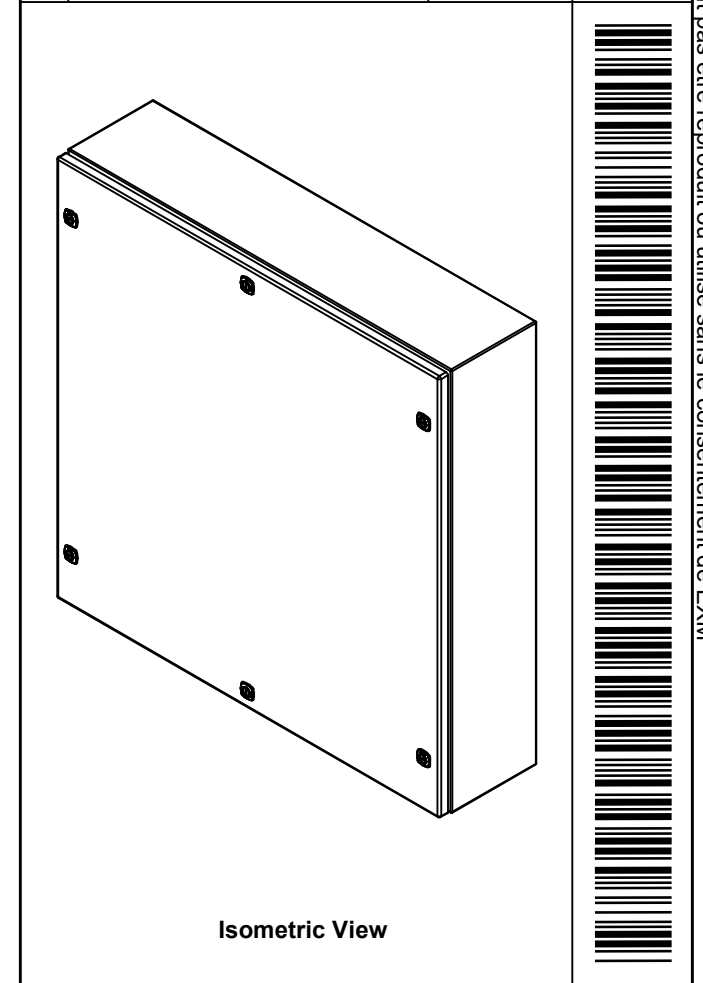

Tél: (450) 979-4373  
Fax: (450) 979-4626  
[www.exmweb.com](http://www.exmweb.com)

Flatness  
Aplatissement  
Max 3.0mm

Projection

Customer Client	Date
Drawn By / Dessiné Par: BoxCad: BoxCad	Date: 02-Feb-26
Material / Matière: 14 Ga Stainless Steel 316 (1.7mm)	

Color / Couleur: Unpainted	Finish / Fini: Brushed
Description: 5412ESSQT 36" x 36" x 8" Assembly	
Part Number / Numéro Pièce: <b>5412ESSQT3636086</b>	Rev. 0

PACKING		
ITEM	QTY	DESCRIPTION
Cardboard sleeve	2	Top and Bottom
Cardboard strip	2	Between back of enclosure and inner panel
Plastic bag	1	To protect cover surface and inside gasket
Plastic strap - Black	2	To Squeeze the 2 cardboard sleeve together
Packaging label	1	White label with product number

Qty	Part Number	Rev	Description
1	STK-K-01800	5	5412 ES Accessory Kit
1	881 SP3636G	0	881 SP - Inner Panel
4	STK-K-01320	0	5412 ES Inner Panel Accessory Kit
1	5412ESSQT3636086C	0	5412ESSQT 36" x 36" Cover
1	5412ESSQT3636086B	0	5412ESSQT 36" x 36" x 8" Body

Parts List

This drawing is confidential and must not be reproduced or used without the consent of EXM

Ce dessin est confidentiel et ne doit pas être reproduit ou utilisé sans le consentement de EXM

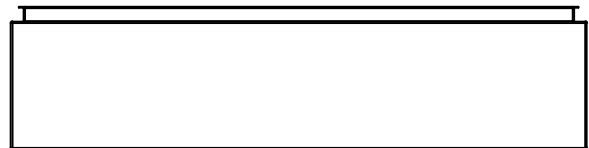

TOP

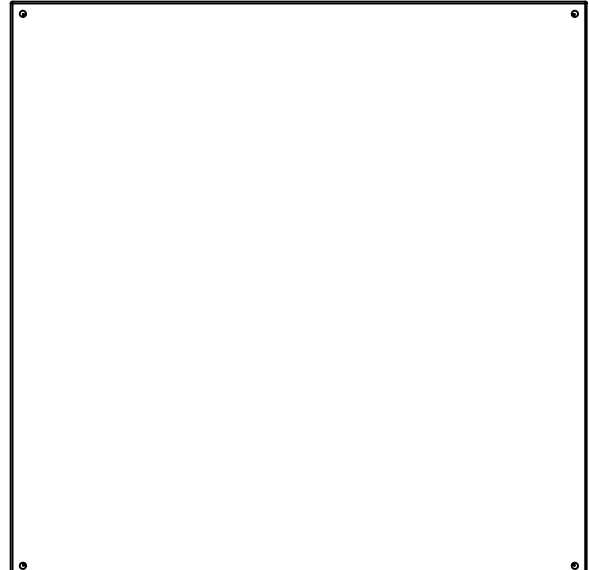

BACK

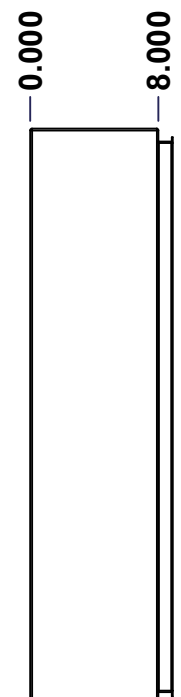

LEFT

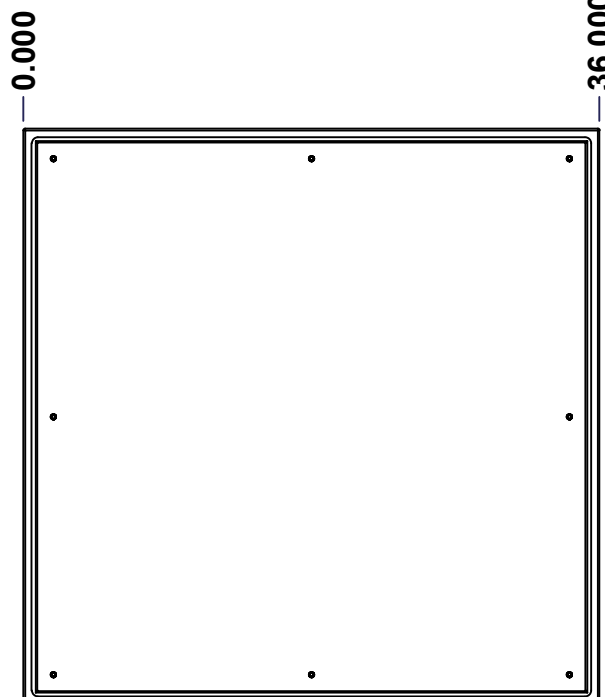

FRONT

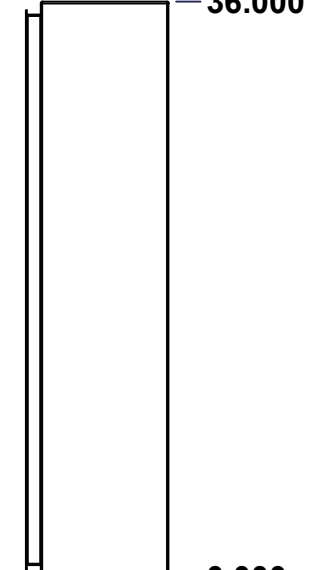

RIGHT

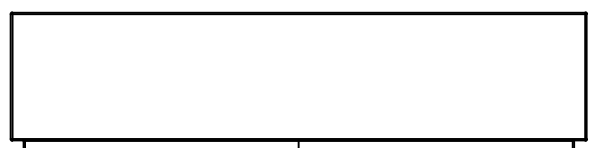

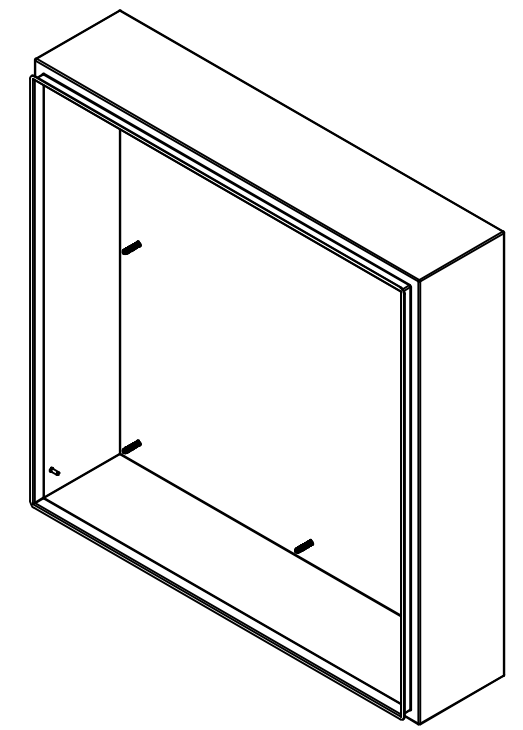

BOTTOM

No.	Revisions	Date	By/Par

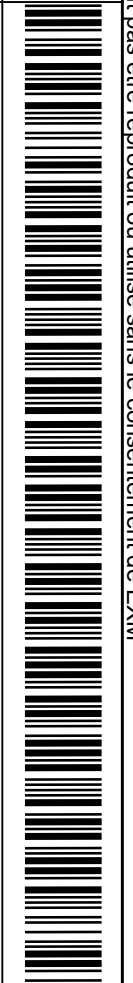

Isometric View

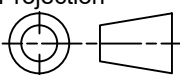

 Tél: (450) 979-4373 Fax: (450) 979-4626 <a href="http://www.exmweb.com">www.exmweb.com</a>		Flatness Aplatissement Max 3.0mm Projection 
Customer Client	Date	
Drawn By Dessiné Par	BoxCad: BoxCad	Date 02-Feb-26
Material Matière	14 Ga Stainless Steel 316 (1.7mm)	
Color Couleur	Unpainted	Finish Fini Brushed
Description	Detail Rev.	
5412ESSQT 36" x 36" x 8" Body		
Part Number Numéro Pièce	Rev.	3
<b>5412ESSQT3636086B</b>	<b>0</b>	9

SEE BILL OF MATERIAL ON LAST PAGE

This drawing is confidential and must not be reproduced or used without the consent of EXM

Ce dessin est confidentiel et ne doit pas être reproduit ou utilisé sans le consentement de EXM

<b>STANDARD FEATURES ARE NOT LISTED IN THIS HOLE TABLE</b>			
<b>HOLE TABLE - LEFT VIEW (CUSTOM FEATURE ONLY)</b>			
CUT-OUT	XDIM	YDIM	DESCRIPTION
1	6.500	2.000	GND STUD M6 x 16mm (Inside)

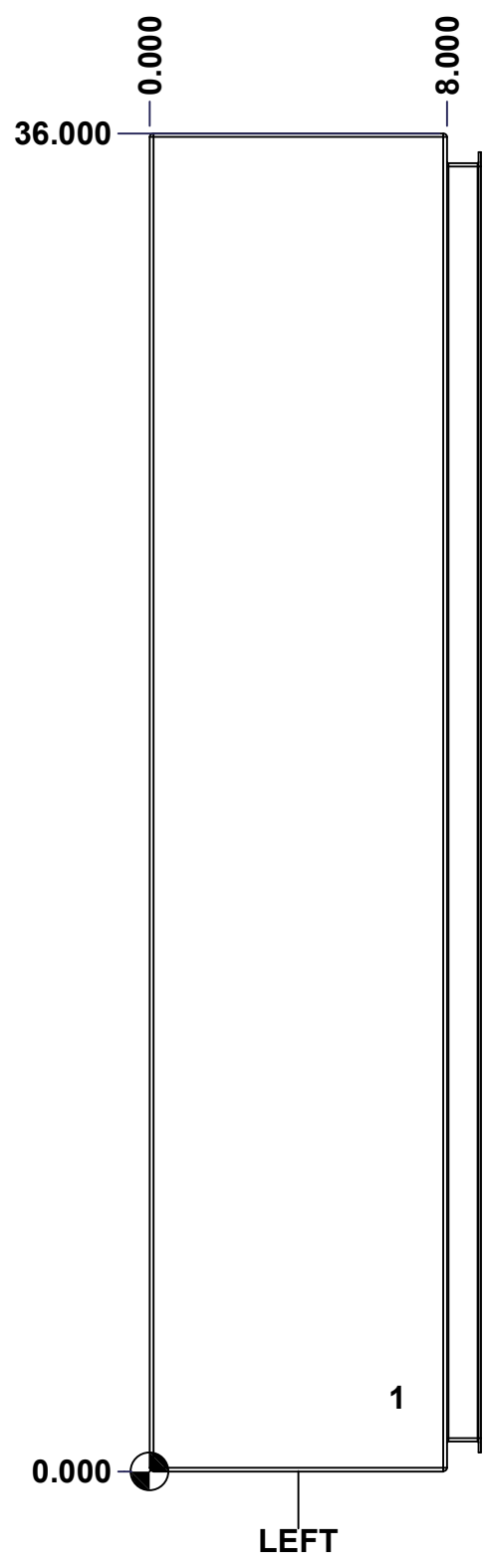

	Description	Status	
	5412ESSQT 36" x 36" x 8" Body	(NULL)	
	Part Number Numéro Pièce	Rev.	
	<b>5412ESSQT3636086B</b>	<b>0</b>	4 9

This drawing is confidential and must not be reproduced or used without the consent of EXM

Ce dessin est confidentiel et ne doit pas être reproduit ou utilisé sans le consentement de EXM

**STANDARD FEATURES ARE NOT LISTED IN THIS HOLE TABLE**

**HOLE TABLE - BACK VIEW (CUSTOM FEATURE ONLY)**

CUT-OUT	XDIM	YDIM	DESCRIPTION
1	1.875	1.875	IP STUD M8 x 35mm (Inside)
2	1.875	34.125	IP STUD M8 x 35mm (Inside)
3	34.125	34.125	IP STUD M8 x 35mm (Inside)
4	34.125	1.875	IP STUD M8 x 35mm (Inside)
5	18.000	1.875	IP STUD M8 x 35mm (Inside)
6	18.000	34.125	IP STUD M8 x 35mm (Inside)
7	1.875	18.000	IP STUD M8 x 35mm (Inside)
8	34.125	18.000	IP STUD M8 x 35mm (Inside)
-----			
9	0.750	0.750	RND Ø0.390
10	0.750	35.250	RND Ø0.390
11	35.250	0.750	RND Ø0.390
12	35.250	35.250	RND Ø0.390

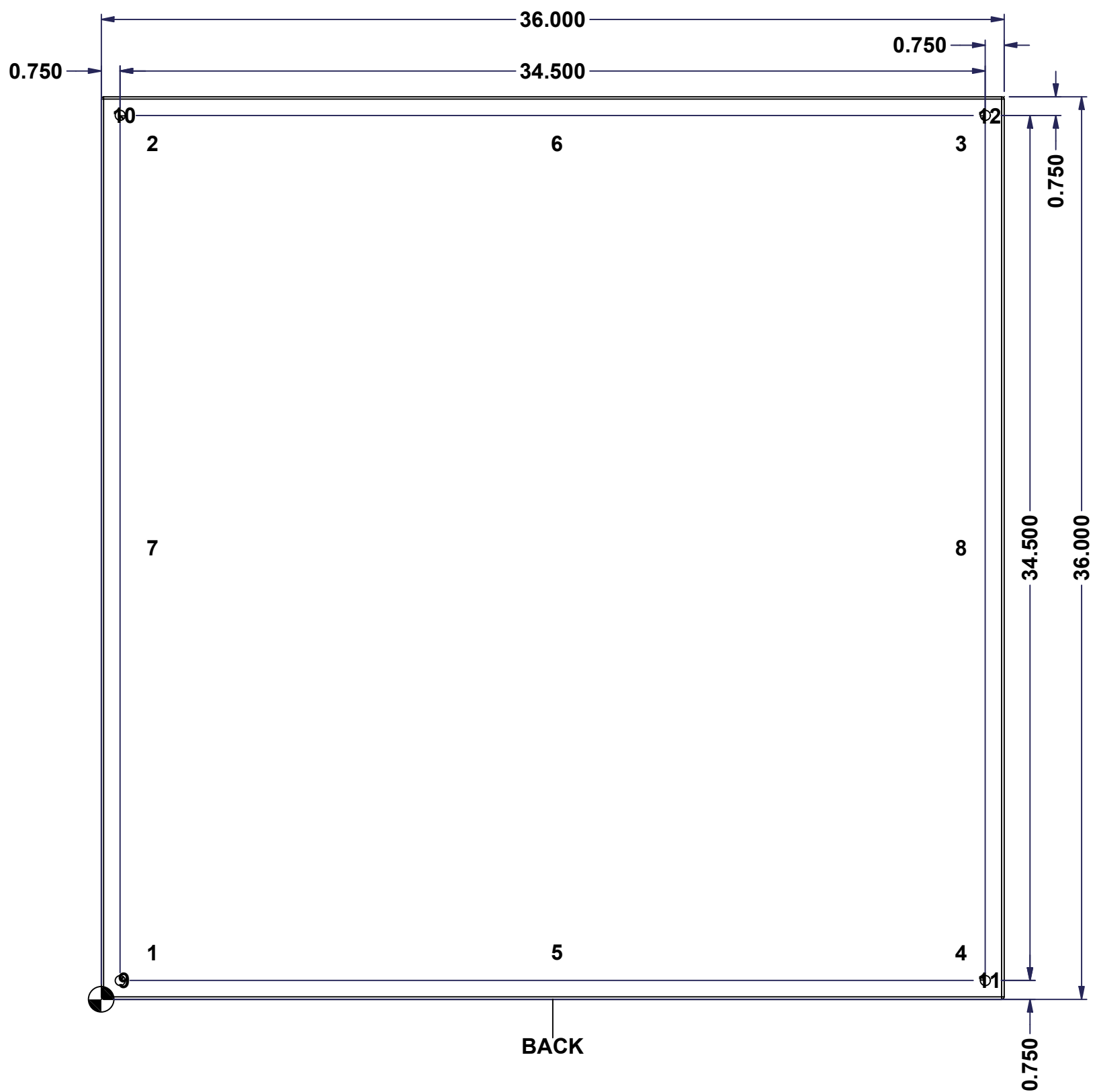



	Description	Status
	5412ESSQT 36" x 36" x 8" Body	(NULL)
	Part Number	Rev.
	5412ESSQT3636086B	5
		9

This drawing is confidential and must not be reproduced or used without the consent of EXM

Ce dessin est confidentiel et ne doit pas être reproduit ou utilisé sans le consentement de EXM

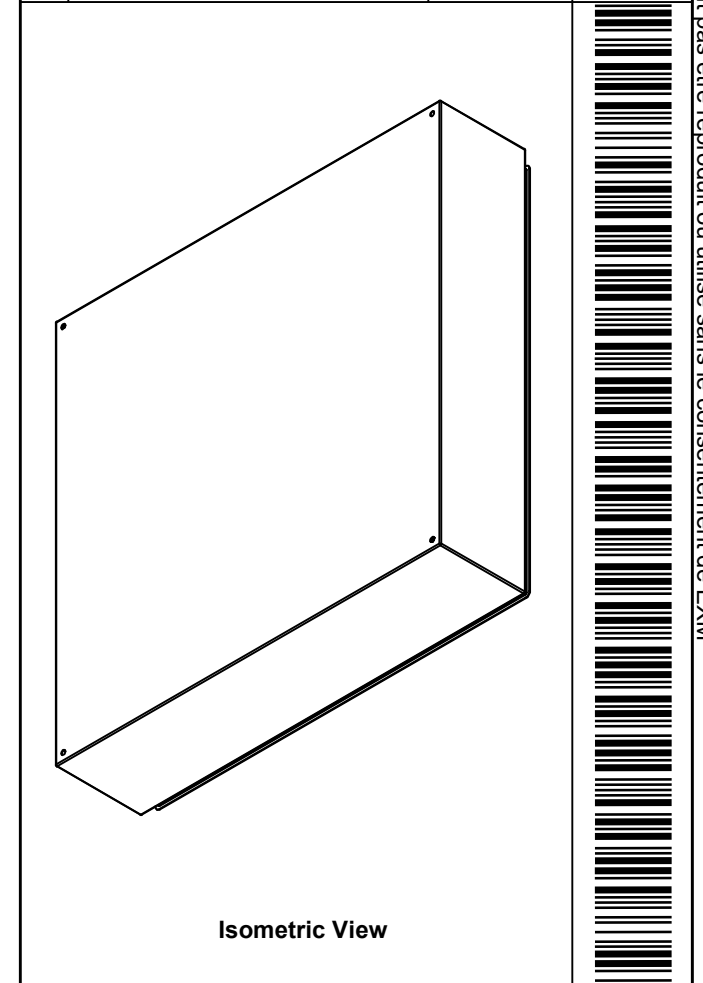
No.	Revisions	Date	By/Par

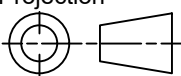

 Tél: (450) 979-4373 Fax: (450) 979-4626 <a href="http://www.exmweb.com">www.exmweb.com</a>		Flatness Aplatissement Max 3.0mm
Customer Client		Projection 
Drawn By / Dessiné Par: BoxCad: BoxCad		Date: 02-Feb-26
Material / Matière: 14 Ga Stainless Steel 316 (1.7mm)		
Color / Couleur: Unpainted	Finish / Fini: Brushed	
Description: 5412ESSQT 36" x 36" x 8" Body		Detail Rev.
Part Number / Numéro Pièce: <b>5412ESSQT3636086B</b>		Rev. 6 0 9

Qty	Part Number	Rev	Description
1	STK-Q-16085	0	Ground Stud M6 x 16mm Stainless Steel
8	STK-Q-16020	1	Stud M8 x 35mm Stainless Steel
1	5412ESSQT3636086B-P	0	5412ESSQT 36" x 36" x 8" Body Part
Parts List			

This drawing is confidential and must not be reproduced or used without the consent of EXM

Ce dessin est confidentiel et ne doit pas être reproduit ou utilisé sans le consentement de EXM

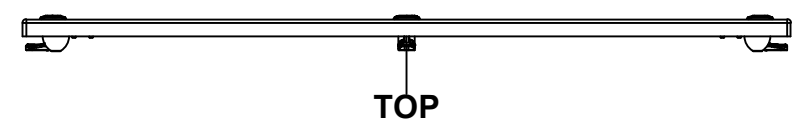

TOP

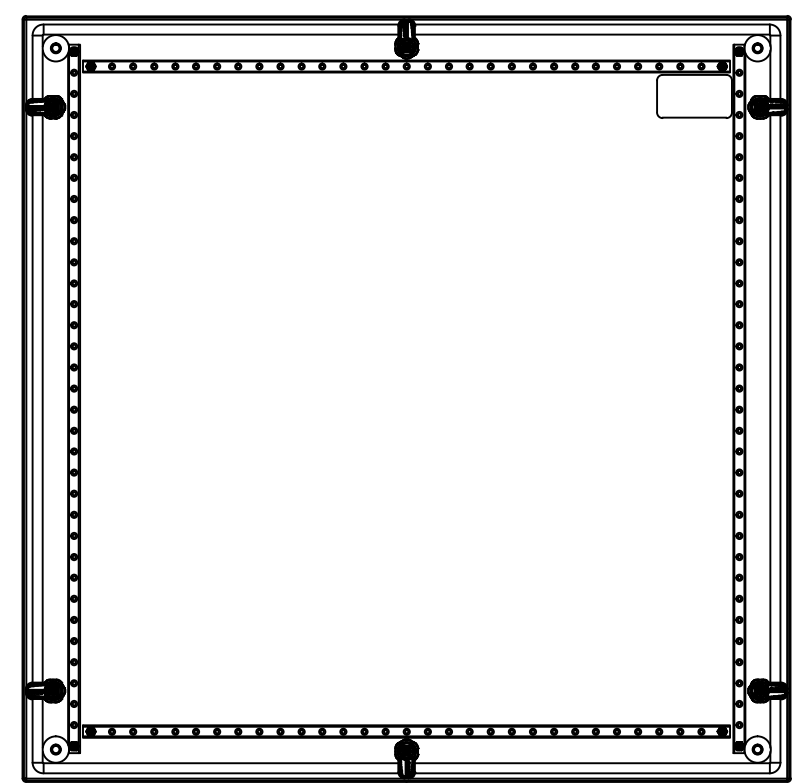

BACK



BOTTOM

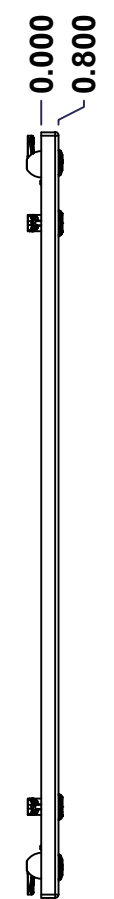

LEFT

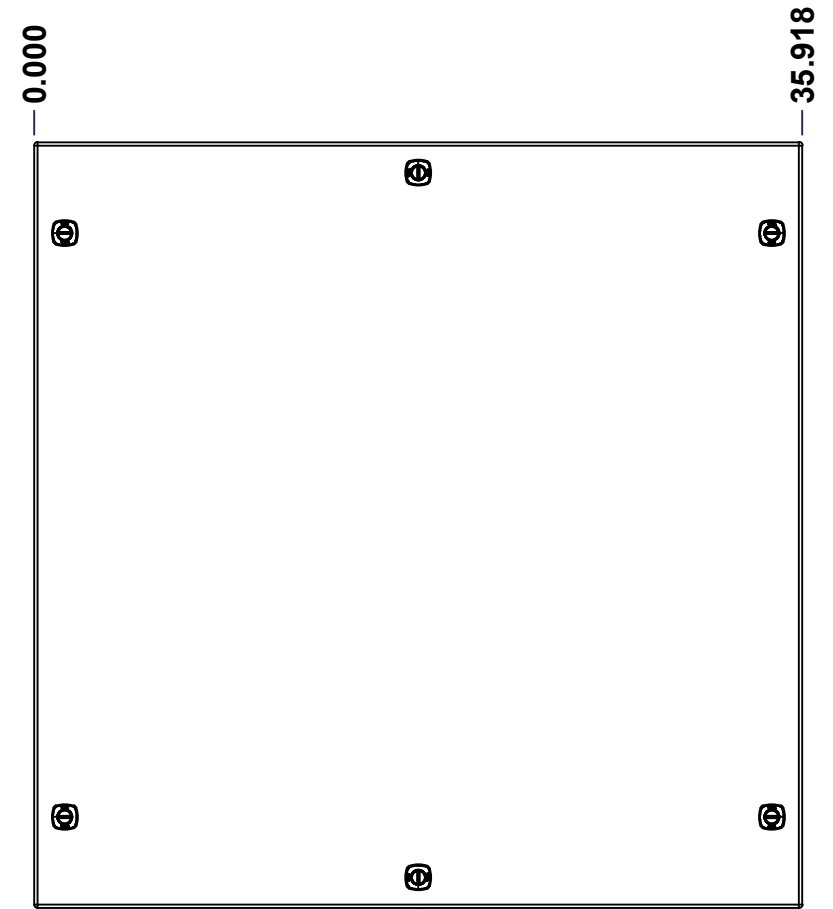

FRONT

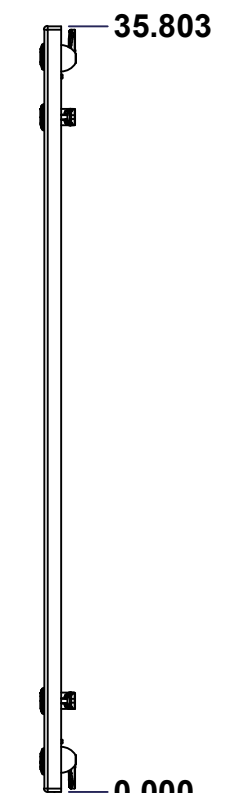

RIGHT

No.	Revisions	Date	By/Par

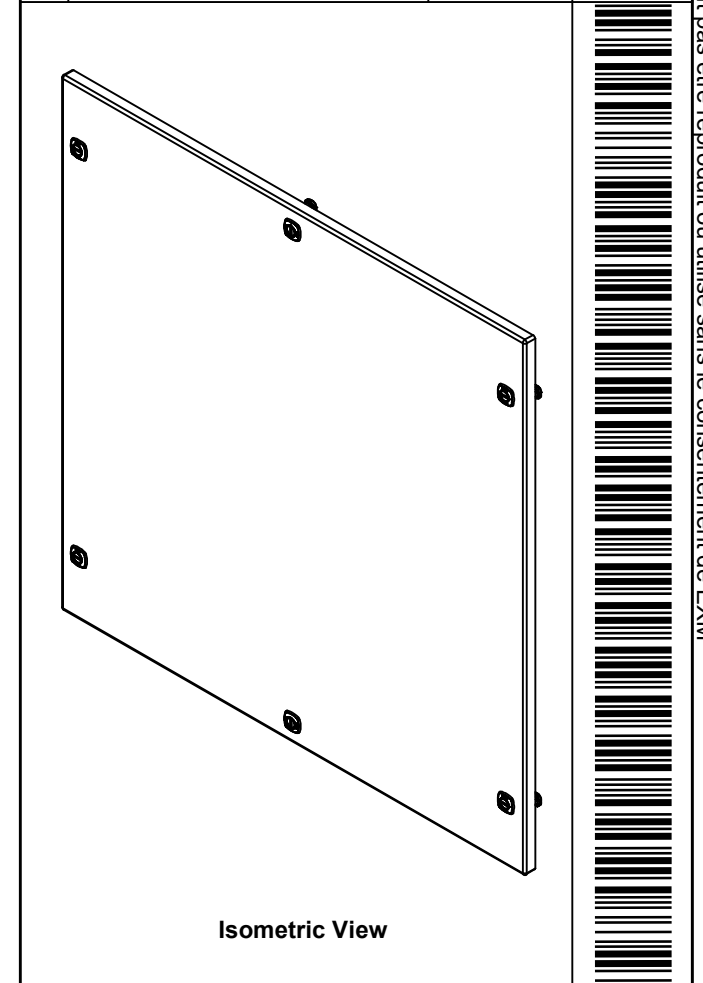

Isometric View

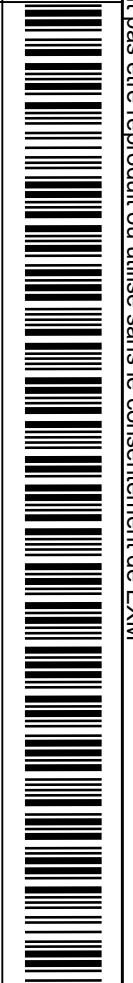

Tél: (450) 979-4373 Fax: (450) 979-4626 <a href="http://www.exmweb.com">www.exmweb.com</a>		Flatness Aplatissement Max 3.0mm Projection 
Customer Client	Date	
Drawn By Dessiné Par	BoxCad: BoxCad	Date 02-Feb-26
Material Matière	14 Ga Stainless Steel 316 (1.7mm)	
Color Couleur	Unpainted	Finish Fini Brushed
Description	Detail Rev.	
5412ESSQT 36" x 36" Cover		
Part Number Numéro Pièce	Rev.	7
5412ESSQT3636086C	0	9

SEE BILL OF MATERIAL ON LAST PAGE

This drawing is confidential and must not be reproduced or used without the consent of EXM

Ce dessin est confidentiel et ne doit pas être reproduit ou utilisé sans le consentement de EXM

STANDARD FEATURES ARE NOT LISTED IN THIS HOLE TABLE			
HOLE TABLE - FRONT VIEW (CUSTOM FEATURE ONLY)			
CUT-OUT	XDIM	YDIM	DESCRIPTION
1	2.401	1.661	STUD M6 x 18mm (Inside)
2	2.401	34.142	STUD M6 x 18mm (Inside)
3	33.517	34.142	STUD M6 x 18mm (Inside)
4	33.517	1.661	STUD M6 x 18mm (Inside)
5	3.195	2.350	STUD M6 x 18mm (Inside)
6	3.195	35.803	STUD M6 x 18mm (Inside)
7	32.723	35.803	STUD M6 x 18mm (Inside)
8	32.723	2.350	STUD M6 x 18mm (Inside)
9	1.550	1.500	STUD M6 x 18mm (Inside)
10	34.368	1.500	STUD M6 x 18mm (Inside)
11	1.550	34.303	STUD M6 x 18mm (Inside)
12	34.368	34.303	STUD M6 x 18mm (Inside)
-----			
13	1.424	4.250	LOCK 880 SCQ4-SLSS6 @ 180.0°
14	1.424	31.553	LOCK 880 SCQ4-SLSS6 @ 180.0°
15	4.500	32.053	LABEL_EXM (Inside)
16	17.959	1.424	LOCK 880 SCQ4-SLSS6 @ 270.0°
17	17.959	34.379	LOCK 880 SCQ4-SLSS6 @ 90.0°
18	34.494	4.250	LOCK 880 SCQ4-SLSS6 @ 0.0°
19	34.494	31.553	LOCK 880 SCQ4-SLSS6 @ 0.0°

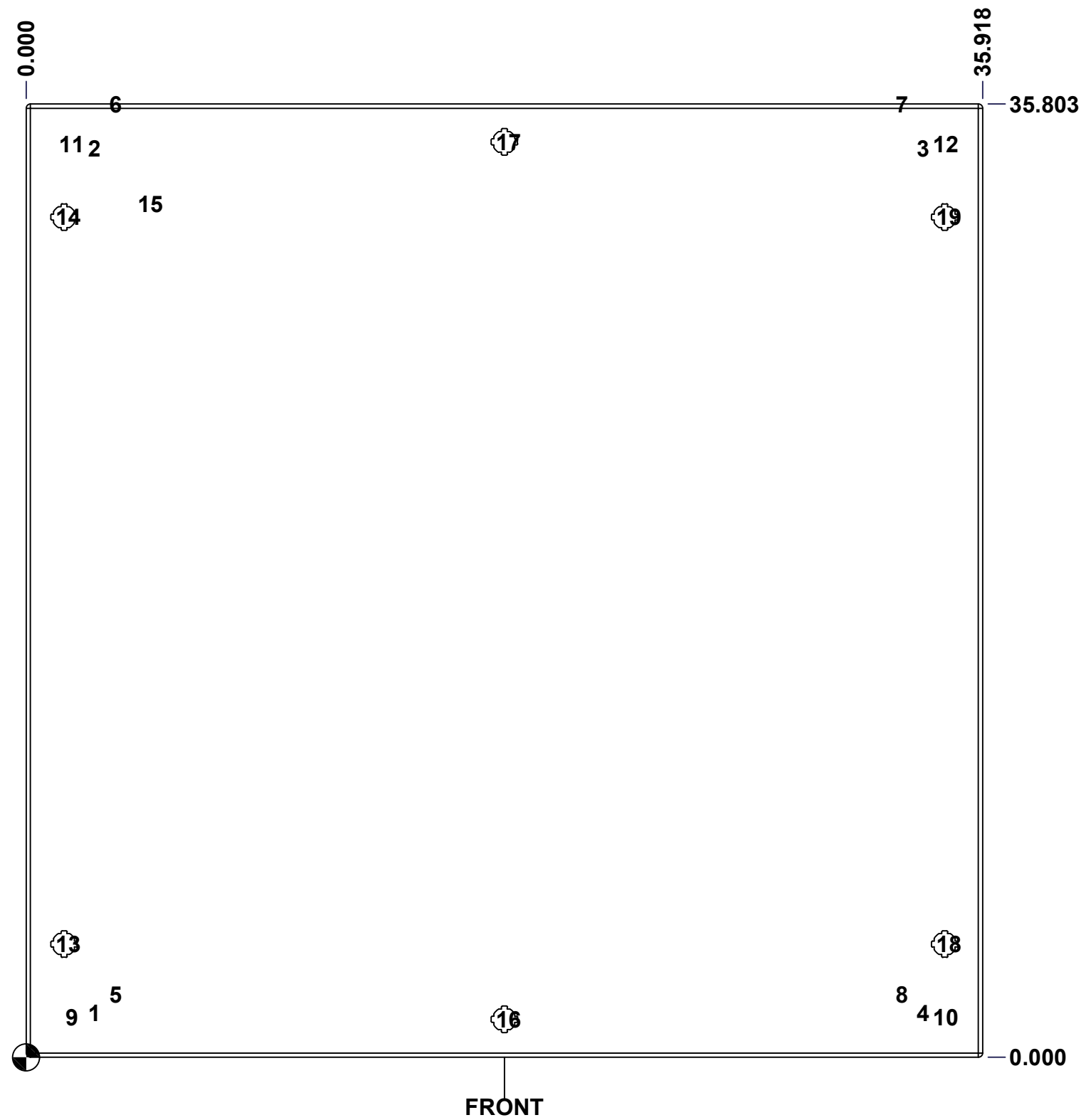

	Description	Status
	5412ESSQT 36" x 36" Cover	(NULL)
	Part Number	Rev.
	Numéro Pièce	8
	<b>5412ESSQT3636086C</b>	<b>0</b>
		9

This drawing is confidential and must not be reproduced or used without the consent of EXM

Ce dessin est confidentiel et ne doit pas être reproduit ou utilisé sans le consentement de EXM

No.	Revisions	Date	By/Par

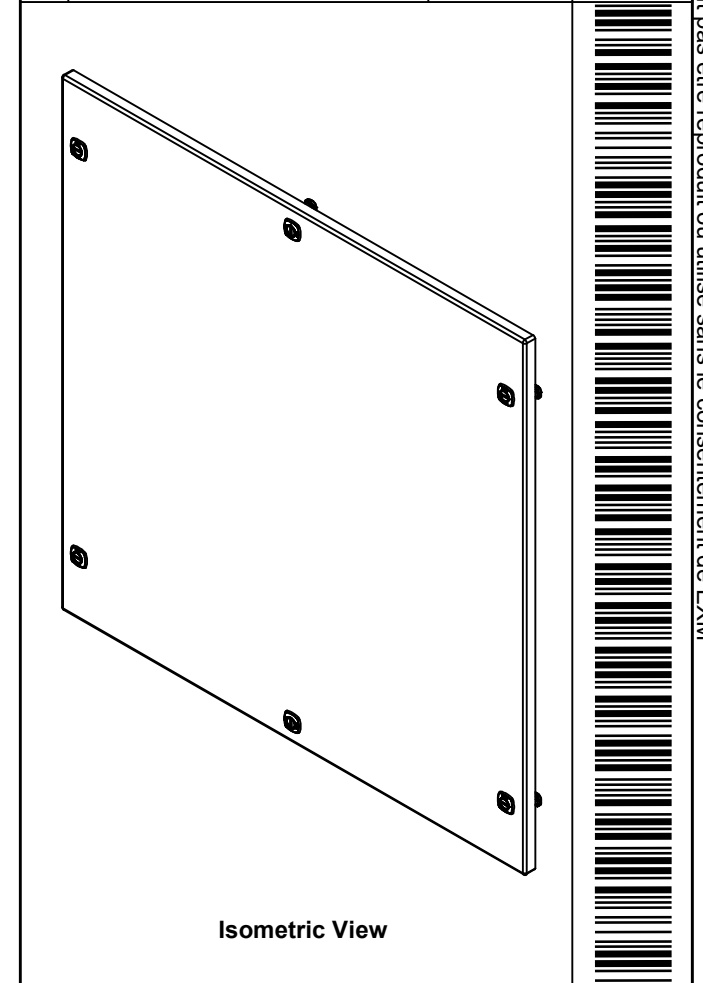

 Tél: (450) 979-4373  
 Fax: (450) 979-4626  
[www.exmweb.com](http://www.exmweb.com)

Flatness  
 Aplatissement  
 Max 3.0mm  
 Projection  

Customer Client	Date
Drawn By Dessiné Par	Date 02-Feb-26

Material Matière: 14 Ga Stainless Steel 316 (1.7mm)

Color Couleur	Unpainted	Finish Fini	Brushed
---------------	-----------	-------------	---------

Description	Detail Rev.
5412ESSQT 36" x 36" Cover	

Part Number Numéro Pièce	Rev.	9
<b>5412ESSQT3636086C</b>	<b>0</b>	9

QTY	Part Number	Rev	Description
1	STK-S-00100	0	3.5" x 2" Silver Milar Flexcon Sticker
6	STK-K-12590	7	5412 ESS 1/4 Turn Lock
8	STK-Q-07220	1	M6 Nylon Insert Lock Nut
2	STK-Q-46025-36-3	6	5412 ES Horizontal Door Stiffener 36" (3 Pts)
2	STK-Q-46020-36	5	5412 ES Vertical Door Stiffener 36"
12	STK-Q-16070	1	Stud M6 x 18mm Stainless steel
1	5412ESSQT3636086G	0	5412ESSQT 36" x 36" Cover Gasket Part
1	5412ESSQT3636086C-P	0	5412ESSQT 36" x 36" Cover Part
4	STK-Q-46515	3	5412 ES Door Support with Brass Insert
Parts List			

This drawing is confidential and must not be reproduced or used without the consent of EXM

Ce dessin est confidentiel et ne doit pas être reproduit ou utilisé sans le consentement de EXM

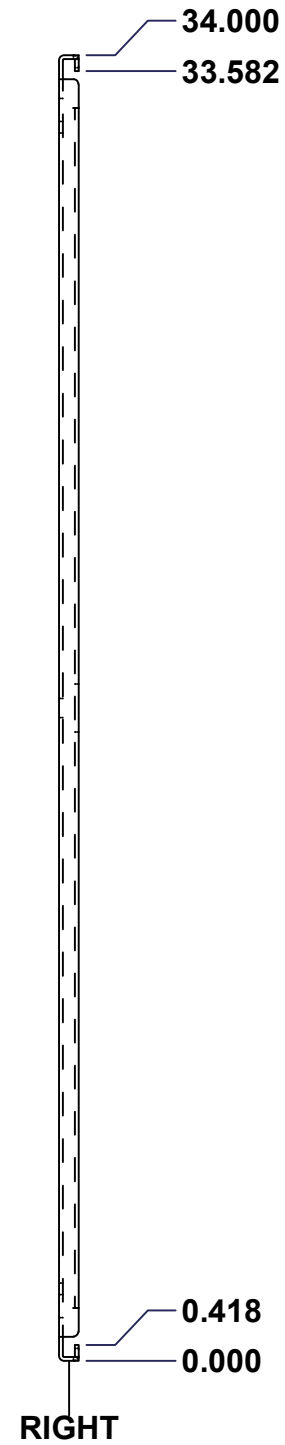
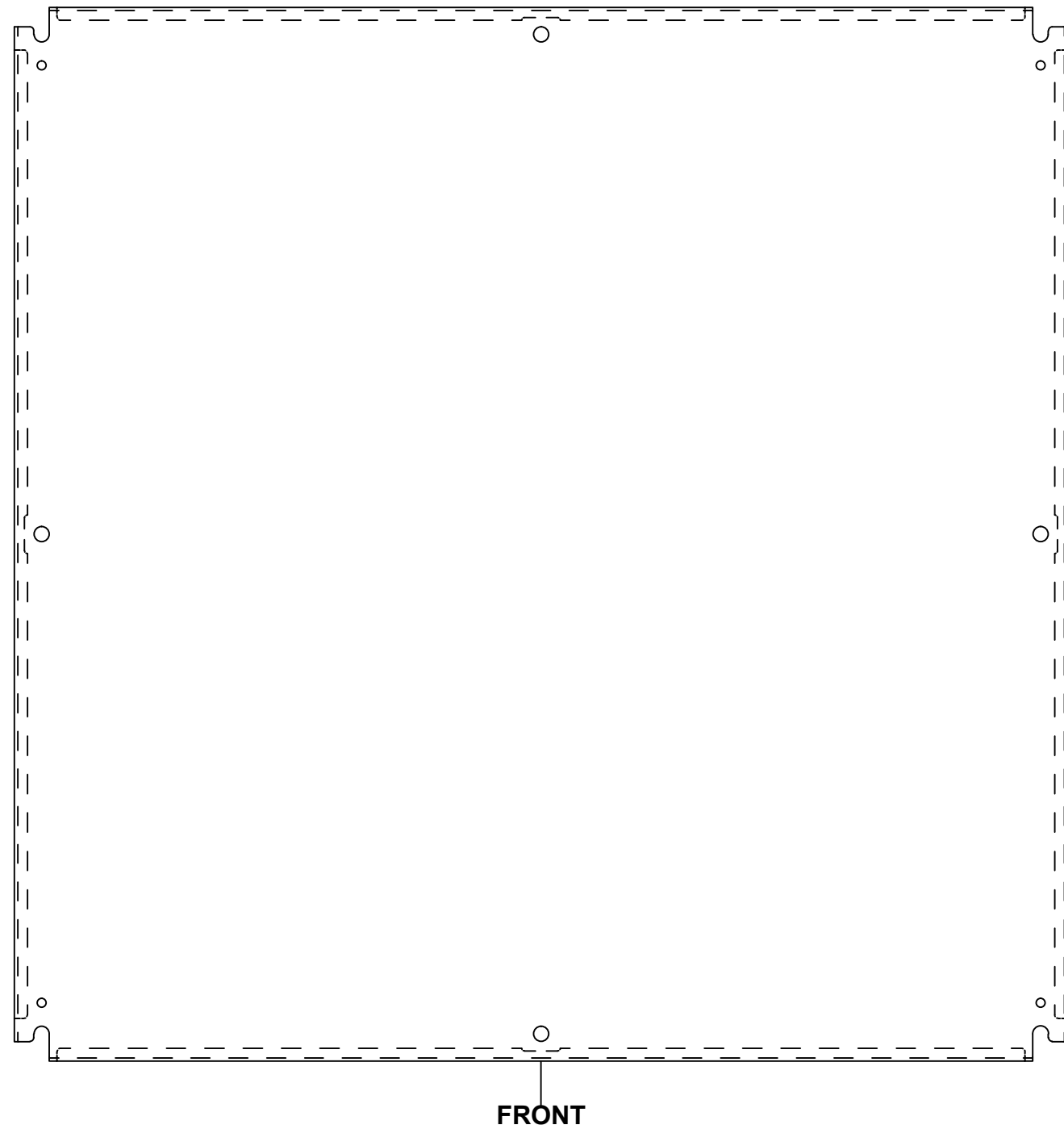
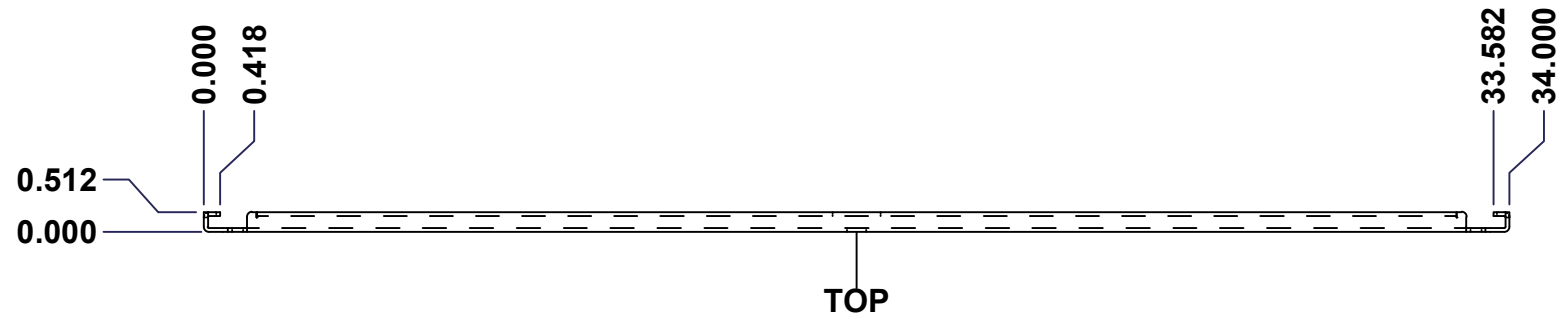

No.	Revisions	Date	By/Par

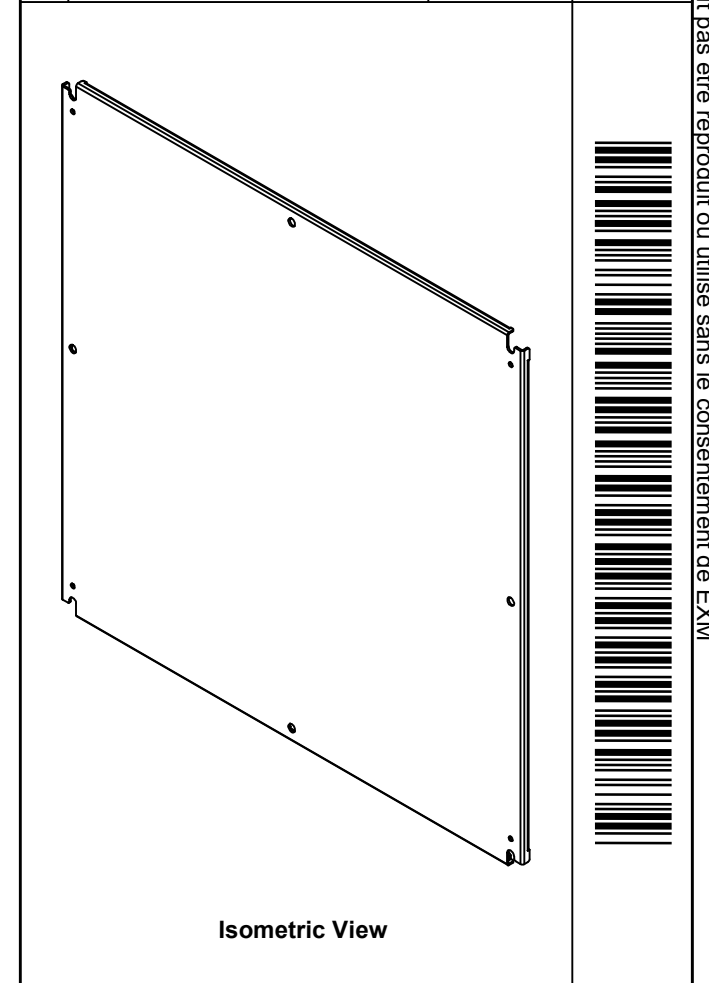

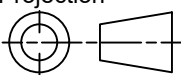
 Tél: (450) 979-4373 Fax: (450) 979-4626 www.exmweb.com		Flatness Aplatissement Max 3.0mm Projection 
Customer Client	Date	
Drawn By Dessiné Par	BoxCad	Date 23-Jan-07
Material Matière	See Part List	
Color Couleur	See Part List	Finish Fini See Part List
Description		Detail Rev.
881 SP - Inner Panel		
Part Number Numéro Pièce	Rev.	1
<b>881 SP3636G</b>	<b>0</b>	2

Qty	Part Number	Rev	Description	Material	Color	Finish
1	881 SP3636G-P	0	881 SP - Inner Panel Part	12 Ga Galvanized	Unpainted	Galvanized

Parts List

This drawing is confidential and must not be reproduced or used without the consent of EXM

Ce dessin est confidentiel et ne doit pas être reproduit ou utilisé sans le consentement de EXM

Table 1			FRONT VIEW
CUT-OUT	XDIM	YDIM	DESCRIPTION
1	17.000	0.875	MTG STUD HOLE (RND Ø0.500)
2	0.875	17.000	MTG STUD HOLE (RND Ø0.500)
3	33.125	17.000	MTG STUD HOLE (RND Ø0.500)
4	17.000	33.125	MTG STUD HOLE (RND Ø0.500)
5	0.875	1.875	GROUND HOLE (RND Ø0.290)
6	33.125	1.875	GROUND HOLE (RND Ø0.290)
7	0.875	32.125	GROUND HOLE (RND Ø0.290)
8	33.125	32.125	GROUND HOLE (RND Ø0.290)

All knockouts are actual size / Les disques défonçables sont grandeur réel

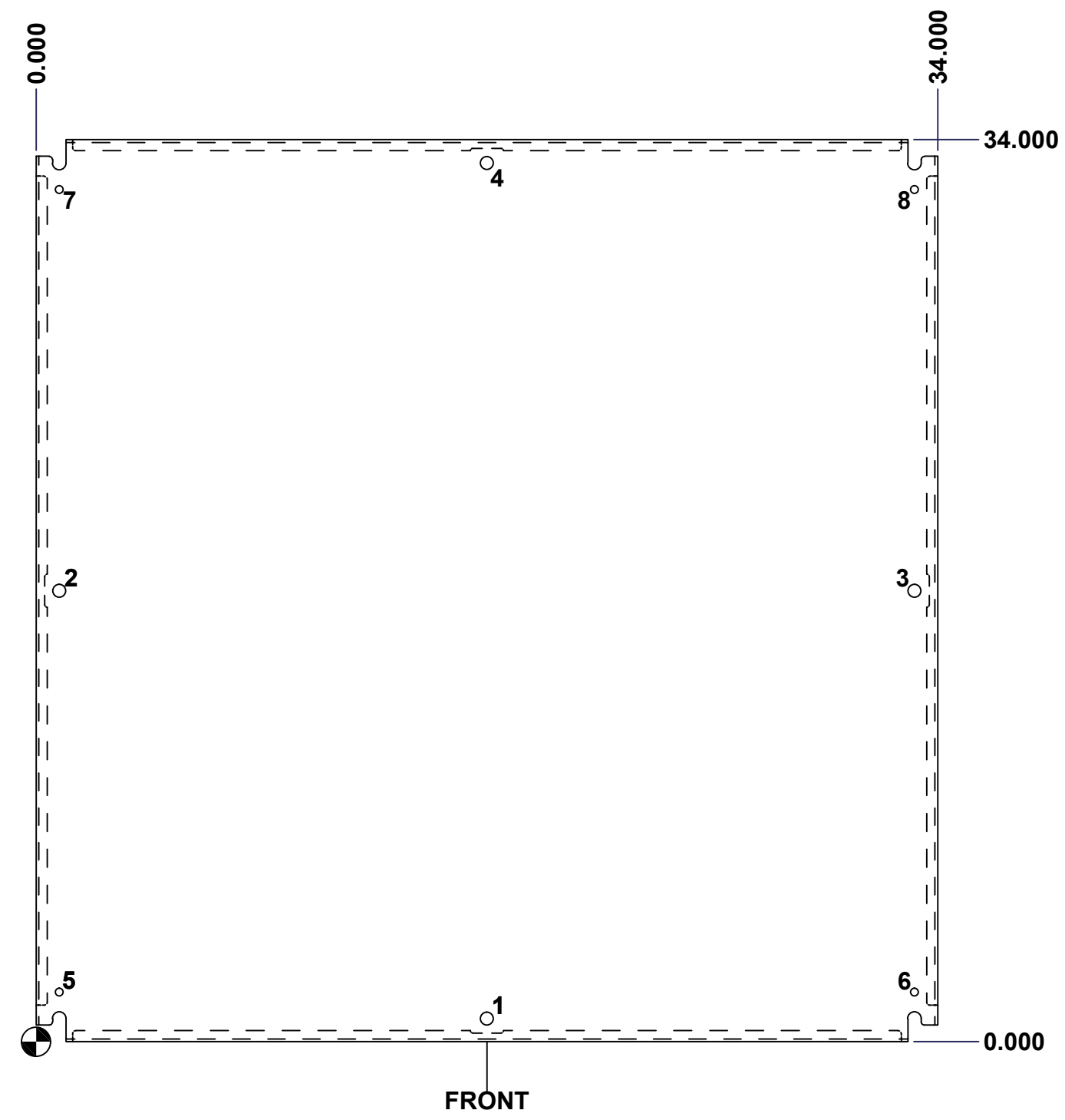

No.	Revisions	Date	By/Par

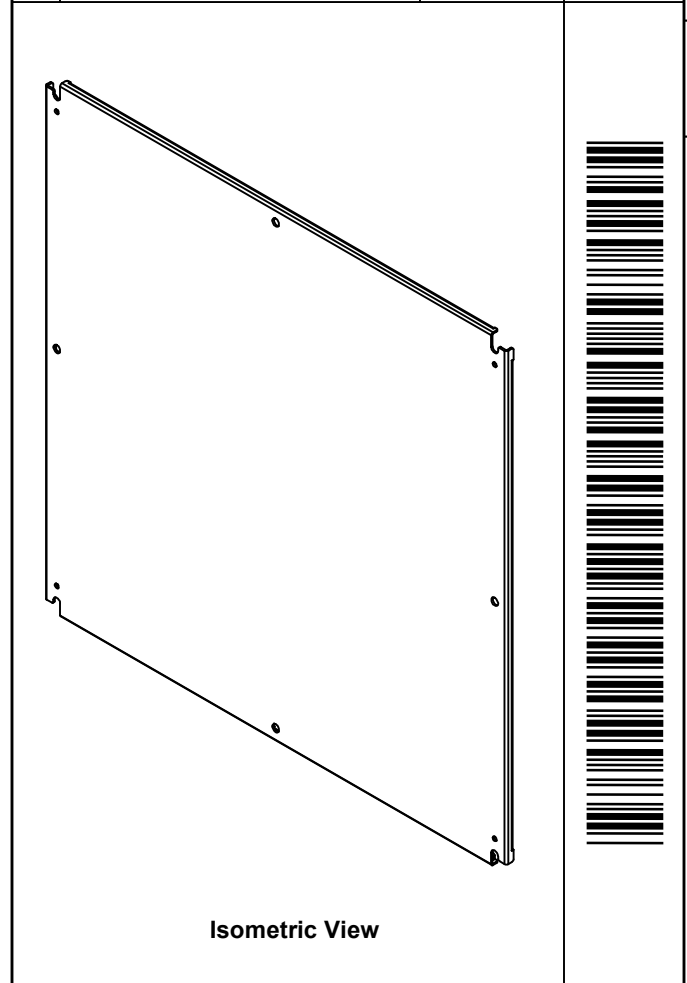

	Tél: (450) 979-4373 Fax: (450) 979-4626 www.exmweb.com	Flatness Aplatissement
		Max 3.0mm
Projection		
Customer Client		Date
Drawn By Dessiné Par	BoxCad	Date 23-Jan-07
Material Matière	See Part List	
Color Couleur	See Part List	Finish Fini See Part List
Description	Detail Rev.	
881 SP - Inner Panel		
Part Number Numéro Pièce	Rev.	2
<b>881 SP3636G</b>	<b>0</b>	<b>2</b>