

This drawing is confidential and must not be reproduced or used without the consent of EXM

Ce dessin est confidentiel et ne doit pas être reproduit ou utilisé sans le consentement de EXM

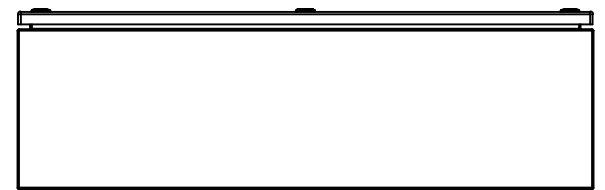

TOP

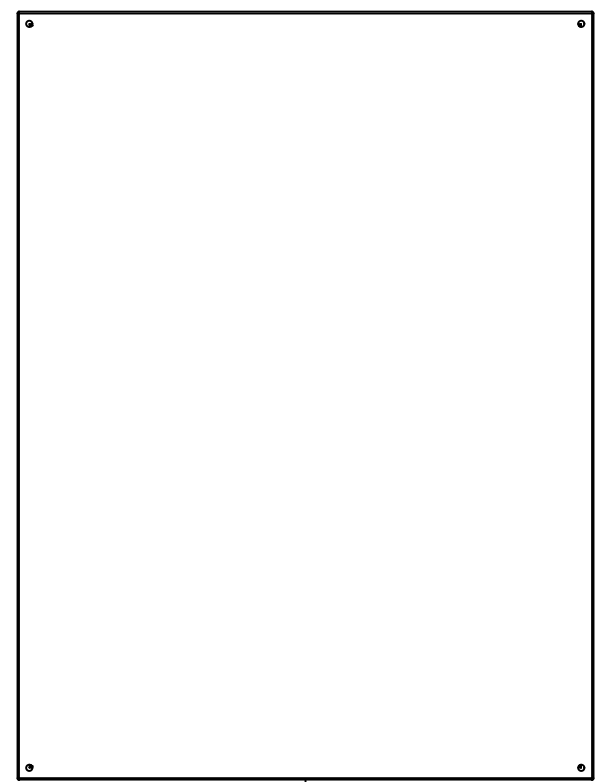

BACK

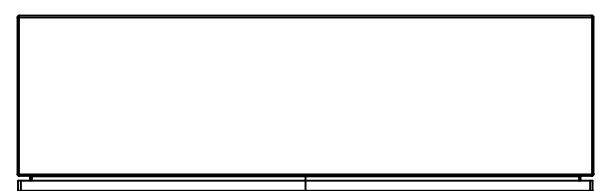

BOTTOM

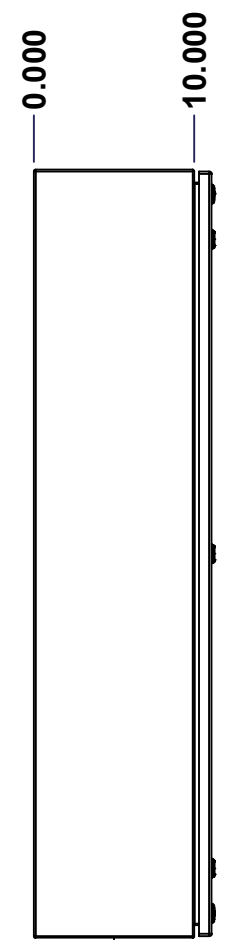

LEFT

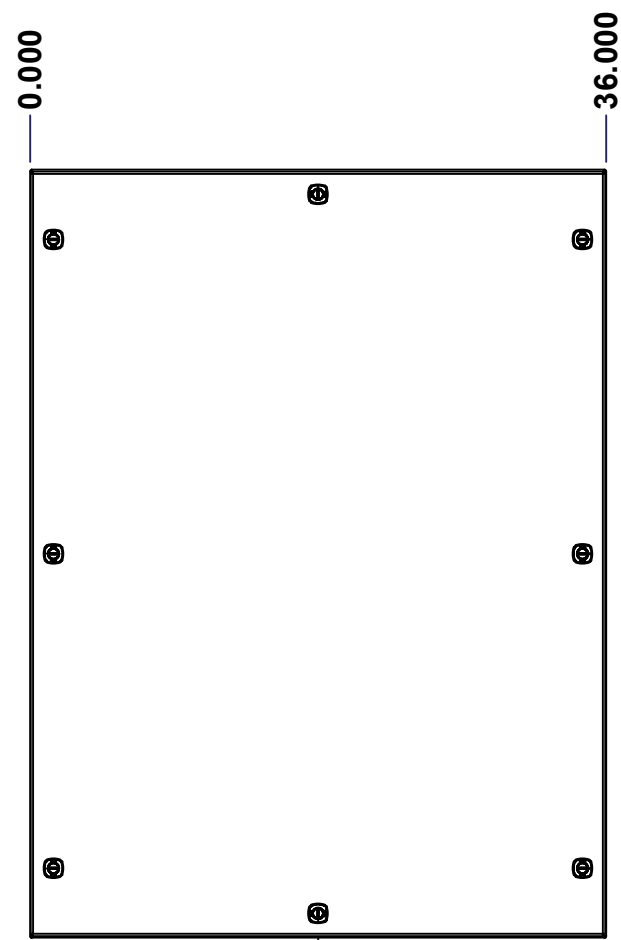

FRONT

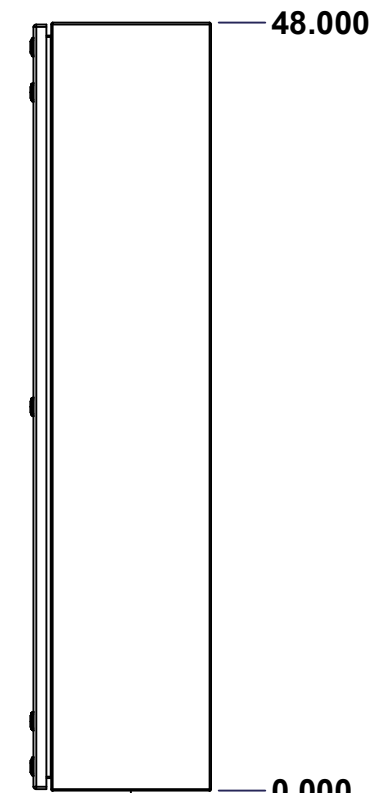

RIGHT

No.	Revisions	Date	By/Par

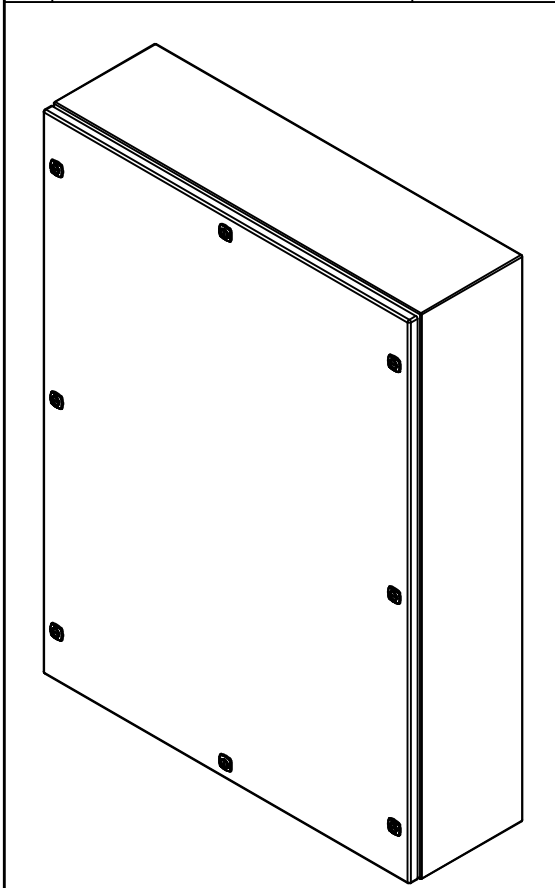

Isometric View



**GRAIN DIRECTION:
TOP/BOTTOM: HORIZONTAL
LEFT/RIGHT/BACK/FRONT: VERTICAL**

SEE BILL OF MATERIAL ON LAST PAGE

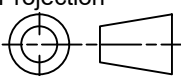
 Tél: (450) 979-4373 Fax: (450) 979-4626 www.exmweb.com		Flatness Aplatissement Max 3.0mm Projection 
Customer Client	Date	
Drawn By Dessiné Par	BoxCad: BoxCad	Date 03-Feb-26
Material Matière	14 Ga Stainless Steel 316 (1.7mm)	
Color Couleur	Unpainted	Finish Fini Brushed
Description	Detail Rev.	
5412ESSQT 48" x 36" x 10" Assembly		
Part Number Numéro Pièce	Rev.	1
5412ESSQT4836106	0	9

This drawing is confidential and must not be reproduced or used without the consent of EXM

Ce dessin est confidentiel et ne doit pas être reproduit ou utilisé sans le consentement de EXM

NOTE	
ITEM	DESCRIPTION
1	NEMA 4X Enclosure (IP66)
2	C/W Standard ground studs on box and cover
3	C/W Standard door stiffener
4	C/W Standard inner panel (Included)
5	C/W Standard inner panel mounting studs

No.	Revisions	Date	By/Par

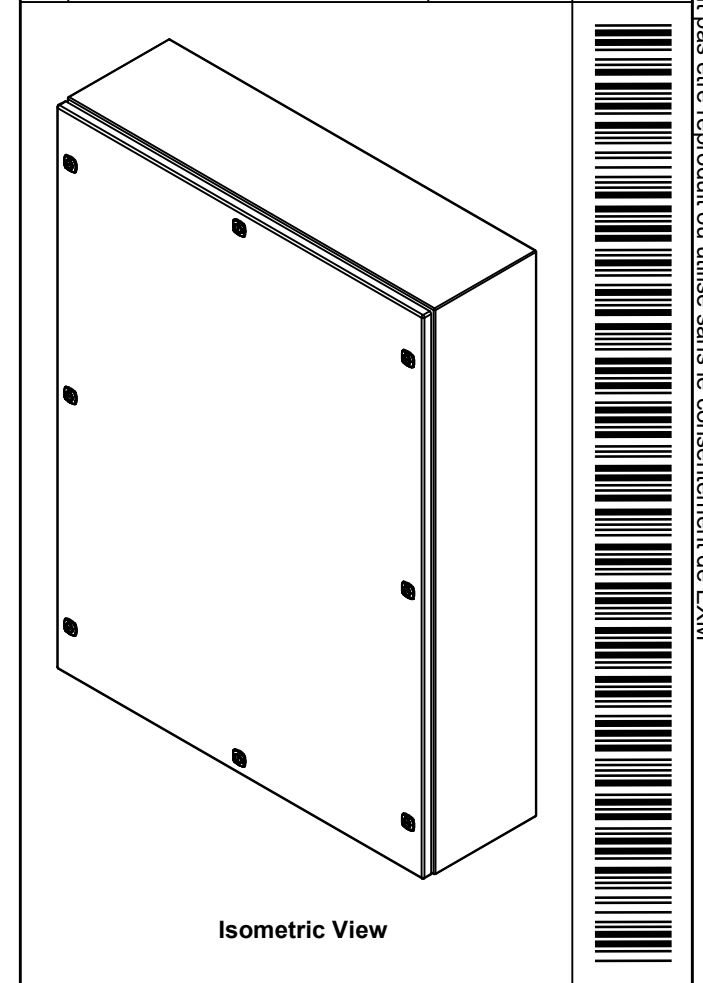

PACKING		
ITEM	QTY	DESCRIPTION
Cardboard sleeve	2	Top and Bottom
Cardboard strip	2	Between back of enclosure and inner panel
Plastic bag	1	To protect cover surface and inside gasket
Cardboard corner	4	To reinforced for the plastic strap tightening
Plastic strap - Black	2	To Squeeze the 2 cardboard sleeve together
Packaging label	3	White label with PN
Plastic strap- Green	2	To secure the enclosure to the wood pallet
Wood Pallet	1	2" deeper and 3" larger than enclosure size

1	STK-K-01800	5	5412 ES Accessory Kit
1	881 SP4836G	0	881 SP - Inner Panel
4	STK-K-01320	0	5412 ES Inner Panel Accessory Kit
1	5412ESSQT4836106C	0	5412ESSQT 48" x 36" Cover
1	5412ESSQT4836106B	0	5412ESSQT 48" x 36" x 10" Body
Qty	Part Number	Rev	Description
Parts List			

Tél: (450) 979-4373 Fax: (450) 979-4626 www.exmweb.com		Flatness Aplatissement Max 3.0mm Projection
Customer Client	Date	
Drawn By Dessiné Par	BoxCad: BoxCad	Date 03-Feb-26
Material Matière	14 Ga Stainless Steel 316 (1.7mm)	
Color Couleur	Unpainted	Finish Fini Brushed
Description		Detail Rev.
5412ESSQT 48" x 36" x 10" Assembly		
Part Number Numéro Pièce	Rev.	2
5412ESSQT4836106	0	9

This drawing is confidential and must not be reproduced or used without the consent of EXM

Ce dessin est confidentiel et ne doit pas être reproduit ou utilisé sans le consentement de EXM

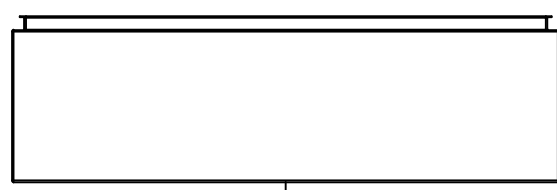

TOP

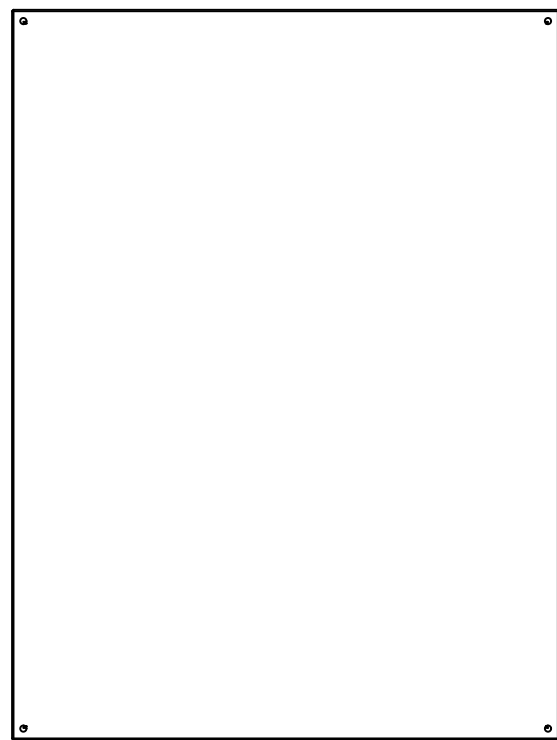

BACK

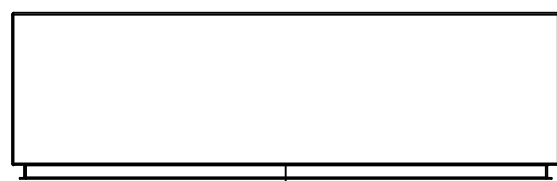

BOTTOM

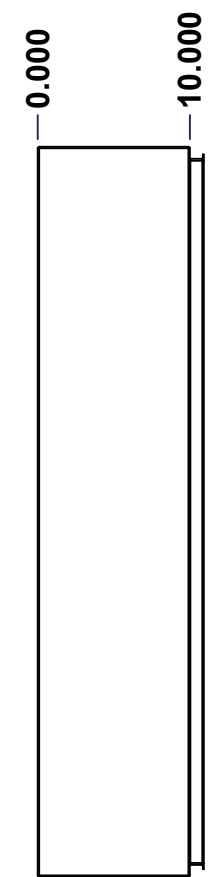

LEFT

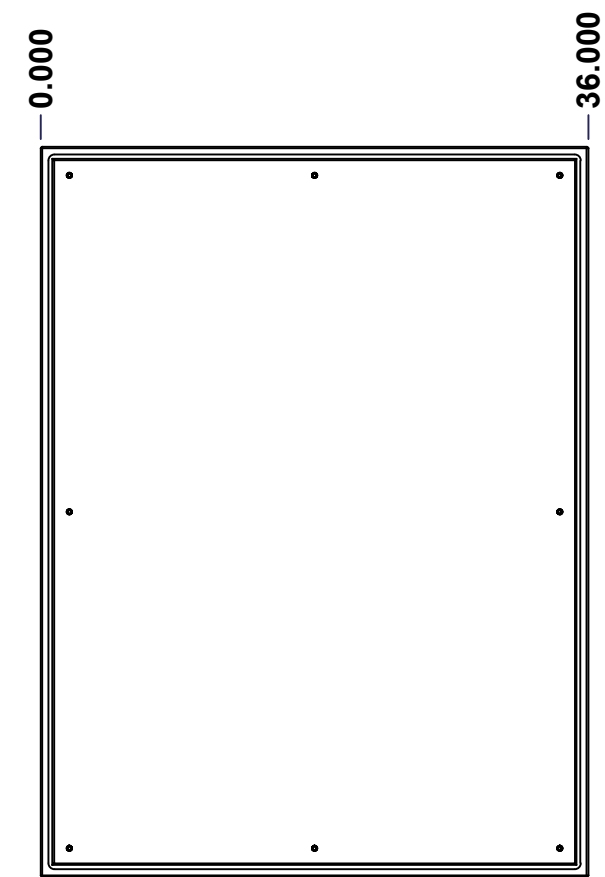

FRONT

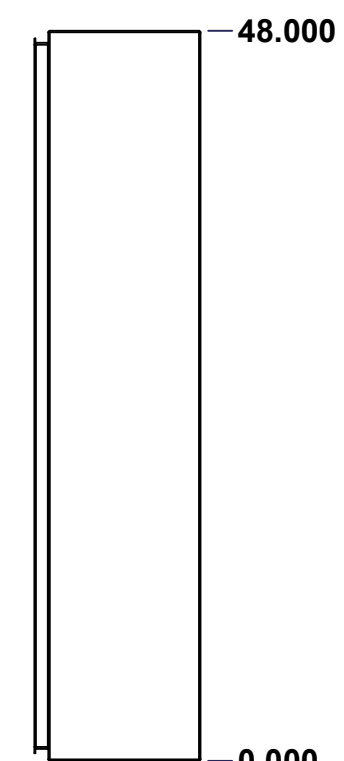

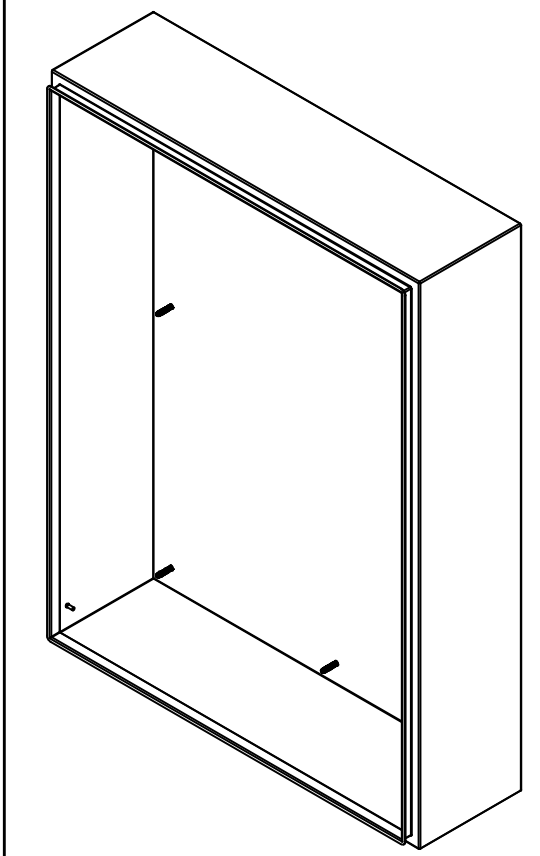

RIGHT

No.	Revisions	Date	By/Par

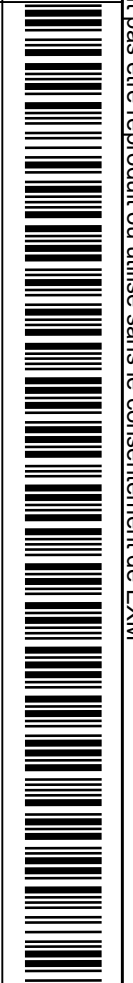

Isometric View

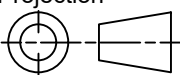

 Tél: (450) 979-4373 Fax: (450) 979-4626 www.exmweb.com		Flatness Aplatissement Max 3.0mm Projection 
Customer Client	Date	
Drawn By Dessiné Par	BoxCad: BoxCad	Date 03-Feb-26
Material Matière	14 Ga Stainless Steel 316 (1.7mm)	
Color Couleur	Unpainted	Finish Fini Brushed
Description	Detail Rev.	
5412ESSQT 48" x 36" x 10" Body		
Part Number Numéro Pièce	Rev.	3
5412ESSQT4836106B	0	9

SEE BILL OF MATERIAL ON LAST PAGE

This drawing is confidential and must not be reproduced or used without the consent of EXM

Ce dessin est confidentiel et ne doit pas être reproduit ou utilisé sans le consentement de EXM

STANDARD FEATURES ARE NOT LISTED IN THIS HOLE TABLE			
HOLE TABLE - LEFT VIEW (CUSTOM FEATURE ONLY)			
CUT-OUT	XDIM	YDIM	DESCRIPTION
1	8.500	2.000	GND STUD M6 x 16mm (Inside)

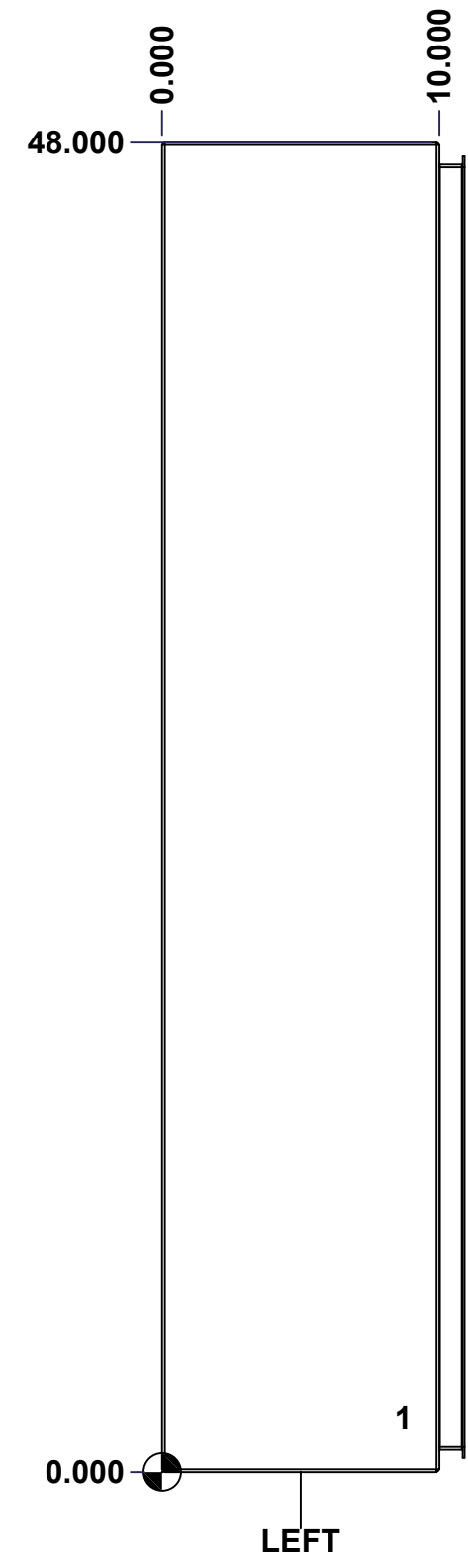

	Description	Status	
	5412ESSQT 48" x 36" x 10" Body	(NULL)	
	Part Number Numéro Pièce	Rev.	
	5412ESSQT4836106B	0	4 9

This drawing is confidential and must not be reproduced or used without the consent of EXM

Ce dessin est confidentiel et ne doit pas être reproduit ou utilisé sans le consentement de EXM

STANDARD FEATURES ARE NOT LISTED IN THIS HOLE TABLE

HOLE TABLE - BACK VIEW (CUSTOM FEATURE ONLY)

CUT-OUT	XDIM	YDIM	DESCRIPTION
1	1.875	1.875	IP STUD M8 x 35mm (Inside)
2	1.875	46.125	IP STUD M8 x 35mm (Inside)
3	34.125	46.125	IP STUD M8 x 35mm (Inside)
4	34.125	1.875	IP STUD M8 x 35mm (Inside)
5	18.000	1.875	IP STUD M8 x 35mm (Inside)
6	18.000	46.125	IP STUD M8 x 35mm (Inside)
7	1.875	24.000	IP STUD M8 x 35mm (Inside)
8	34.125	24.000	IP STUD M8 x 35mm (Inside)

9	0.750	0.750	RND Ø0.390
10	0.750	47.250	RND Ø0.390
11	35.250	0.750	RND Ø0.390
12	35.250	47.250	RND Ø0.390

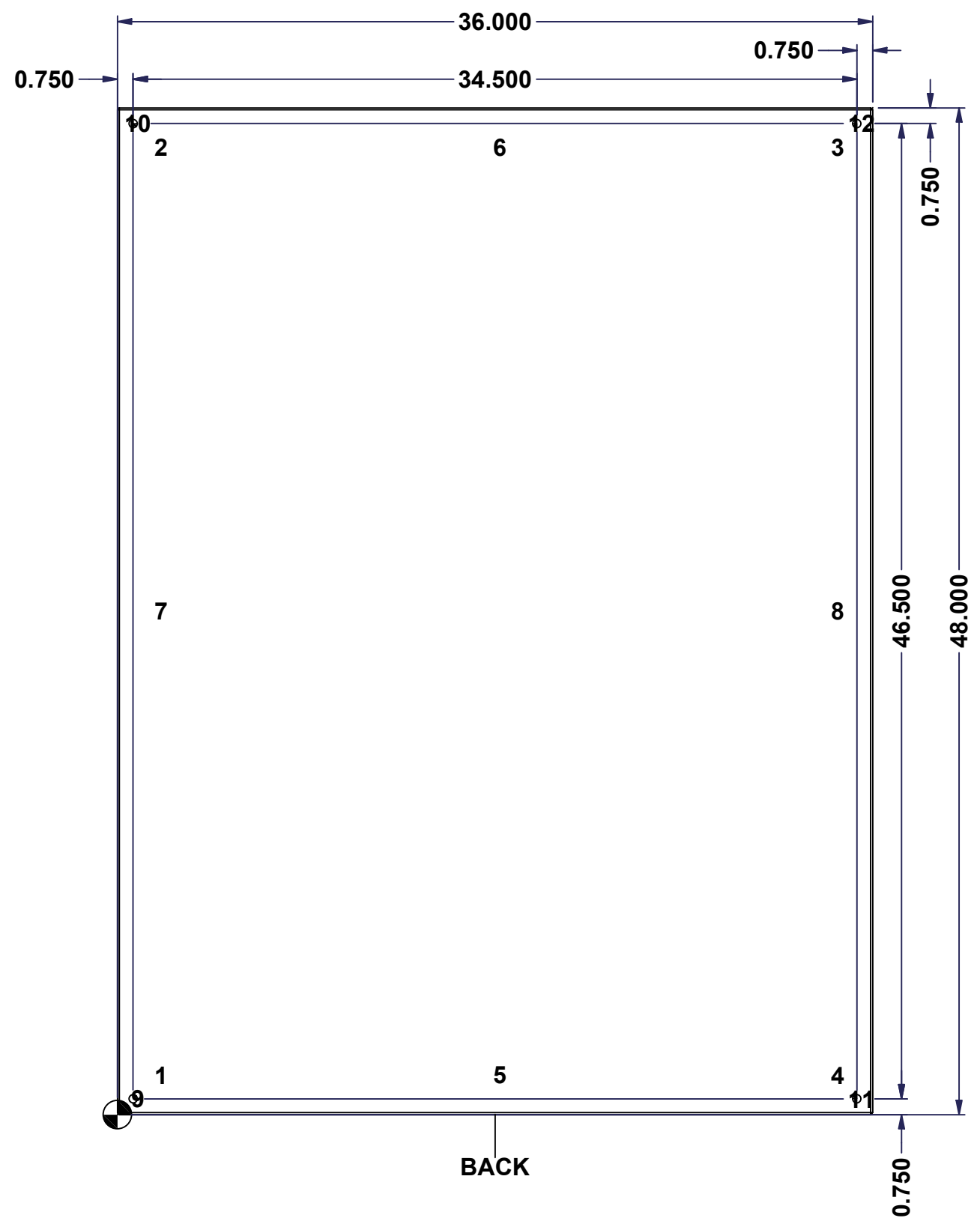



	Description	Status	
	5412ESSQT 48" x 36" x 10" Body	(NULL)	
	Part Number	Rev.	5
	Numéro Pièce	0	9
	5412ESSQT4836106B		

This drawing is confidential and must not be reproduced or used without the consent of EXM

Ce dessin est confidentiel et ne doit pas être reproduit ou utilisé sans le consentement de EXM

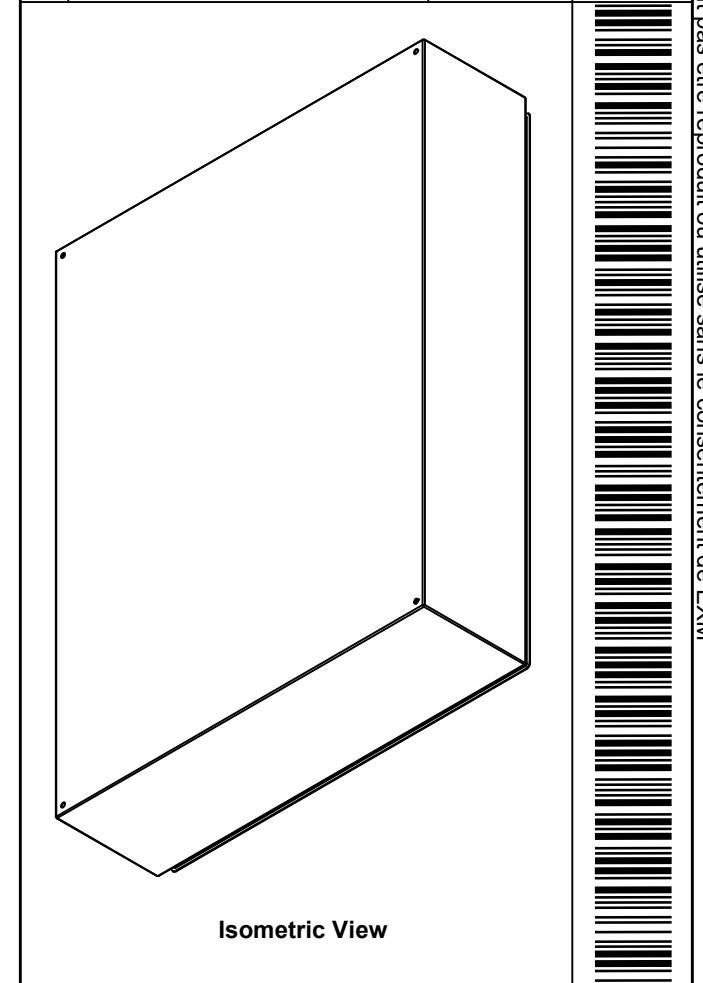
No.	Revisions	Date	By/Par

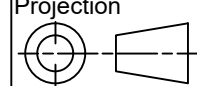

 Tél: (450) 979-4373 Fax: (450) 979-4626 www.exmweb.com		Flatness Aplatissement Max 3.0mm
Customer Client		Projection 
Drawn By / Dessiné Par: BoxCad: BoxCad		Date: 03-Feb-26
Material / Matière: 14 Ga Stainless Steel 316 (1.7mm)		
Color / Couleur: Unpainted	Finish / Fini: Brushed	
Description: 5412ESSQT 48" x 36" x 10" Body		Detail Rev.
Part Number / Numéro Pièce: 5412ESSQT4836106B		Rev. 6 0 9

Qty	Part Number	Rev	Description
1	STK-Q-16085	0	Ground Stud M6 x 16mm Stainless Steel
8	STK-Q-16020	1	Stud M8 x 35mm Stainless Steel
1	5412ESSQT4836106B-P	0	5412ESSQT 48" x 36" x 10" Body Part
Parts List			

This drawing is confidential and must not be reproduced or used without the consent of EXM

Ce dessin est confidentiel et ne doit pas être reproduit ou utilisé sans le consentement de EXM

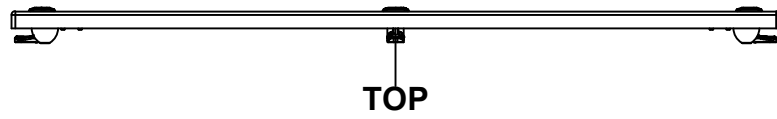

TOP

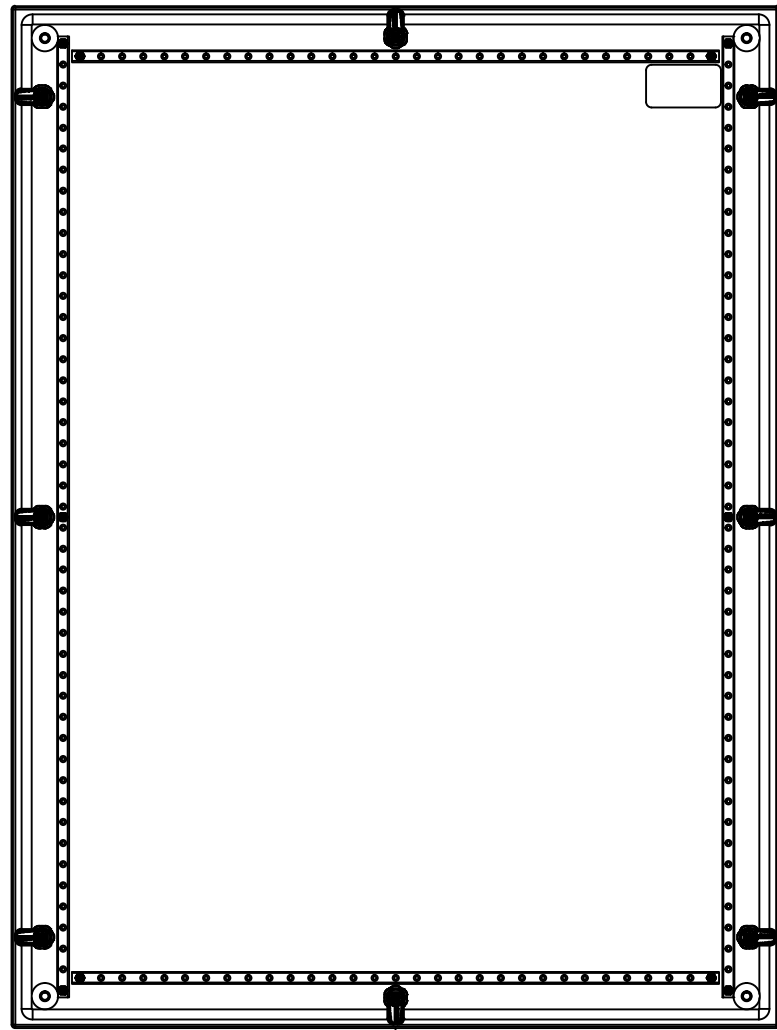

BACK



BOTTOM

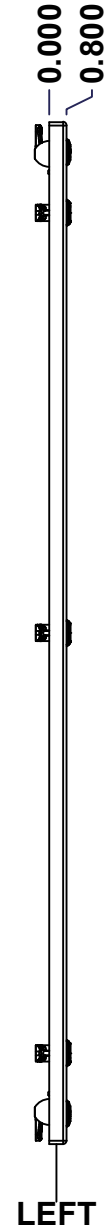

LEFT

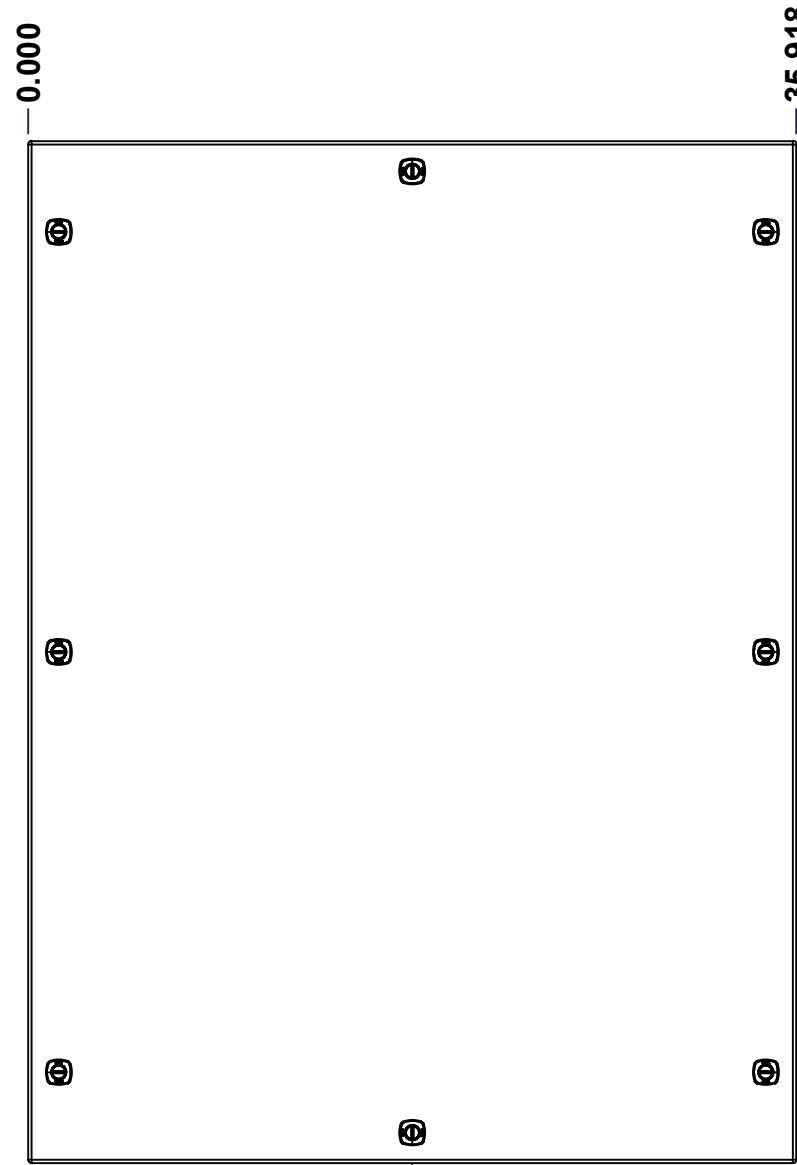

FRONT

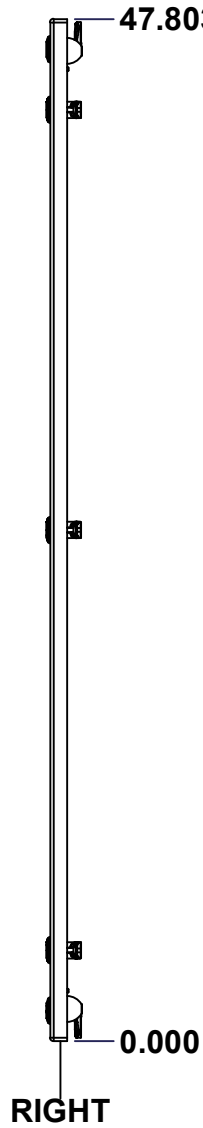

RIGHT

No.	Revisions	Date	By/Par

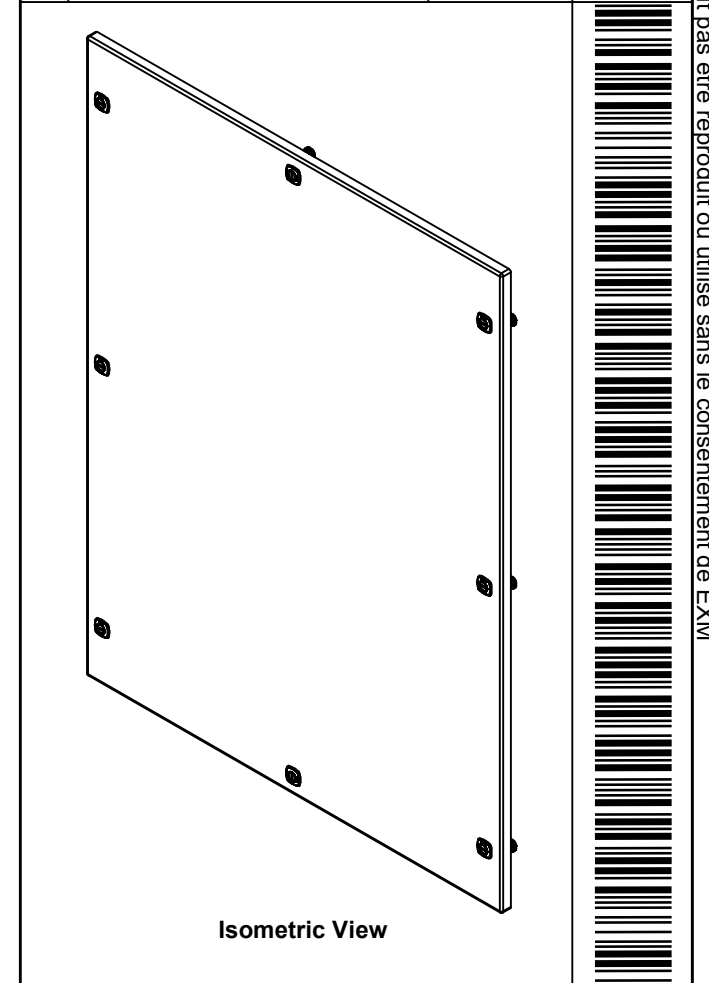

Isometric View



 Tél: (450) 979-4373 Fax: (450) 979-4626 www.exmweb.com		Flatness Aplatissement	
		Max 3.0mm	
Customer Client		Date	
Drawn By Dessiné Par BoxCad: BoxCad		Date 03-Feb-26	
Material Matière 14 Ga Stainless Steel 316 (1.7mm)			
Color Couleur Unpainted		Finish Fini Brushed	
Description 5412ESSQT 48" x 36" Cover			Detail Rev.
Part Number Numéro Pièce 5412ESSQT4836106C		Rev. 0	7/9

SEE BILL OF MATERIAL ON LAST PAGE

This drawing is confidential and must not be reproduced or used without the consent of EXM

Ce dessin est confidentiel et ne doit pas être reproduit ou utilisé sans le consentement de EXM

STANDARD FEATURES ARE NOT LISTED IN THIS HOLE TABLE

HOLE TABLE - FRONT VIEW (CUSTOM FEATURE ONLY)

CUT-OUT	XDIM	YDIM	DESCRIPTION
1	2.401	1.756	STUD M6 x 18mm (Inside)
2	2.401	46.047	STUD M6 x 18mm (Inside)
3	33.517	46.047	STUD M6 x 18mm (Inside)
4	33.517	1.756	STUD M6 x 18mm (Inside)
5	2.401	23.902	STUD M6 x 18mm (Inside)
6	33.517	23.902	STUD M6 x 18mm (Inside)
7	3.195	2.350	STUD M6 x 18mm (Inside)
8	3.195	47.803	STUD M6 x 18mm (Inside)
9	32.723	47.803	STUD M6 x 18mm (Inside)
10	32.723	2.350	STUD M6 x 18mm (Inside)
11	1.550	1.500	STUD M6 x 18mm (Inside)
12	34.368	1.500	STUD M6 x 18mm (Inside)
13	1.550	46.303	STUD M6 x 18mm (Inside)
14	34.368	46.303	STUD M6 x 18mm (Inside)

15	1.424	4.250	LOCK 880 SCQ4-SLSS6 @ 180.0°
16	1.424	23.902	LOCK 880 SCQ4-SLSS6 @ 180.0°
17	1.424	43.553	LOCK 880 SCQ4-SLSS6 @ 180.0°
18	4.500	44.053	LABEL_EXM (Inside)
19	17.959	1.424	LOCK 880 SCQ4-SLSS6 @ 270.0°
20	17.959	46.379	LOCK 880 SCQ4-SLSS6 @ 90.0°
21	34.494	4.250	LOCK 880 SCQ4-SLSS6 @ 0.0°
22	34.494	23.902	LOCK 880 SCQ4-SLSS6 @ 0.0°
23	34.494	43.553	LOCK 880 SCQ4-SLSS6 @ 0.0°

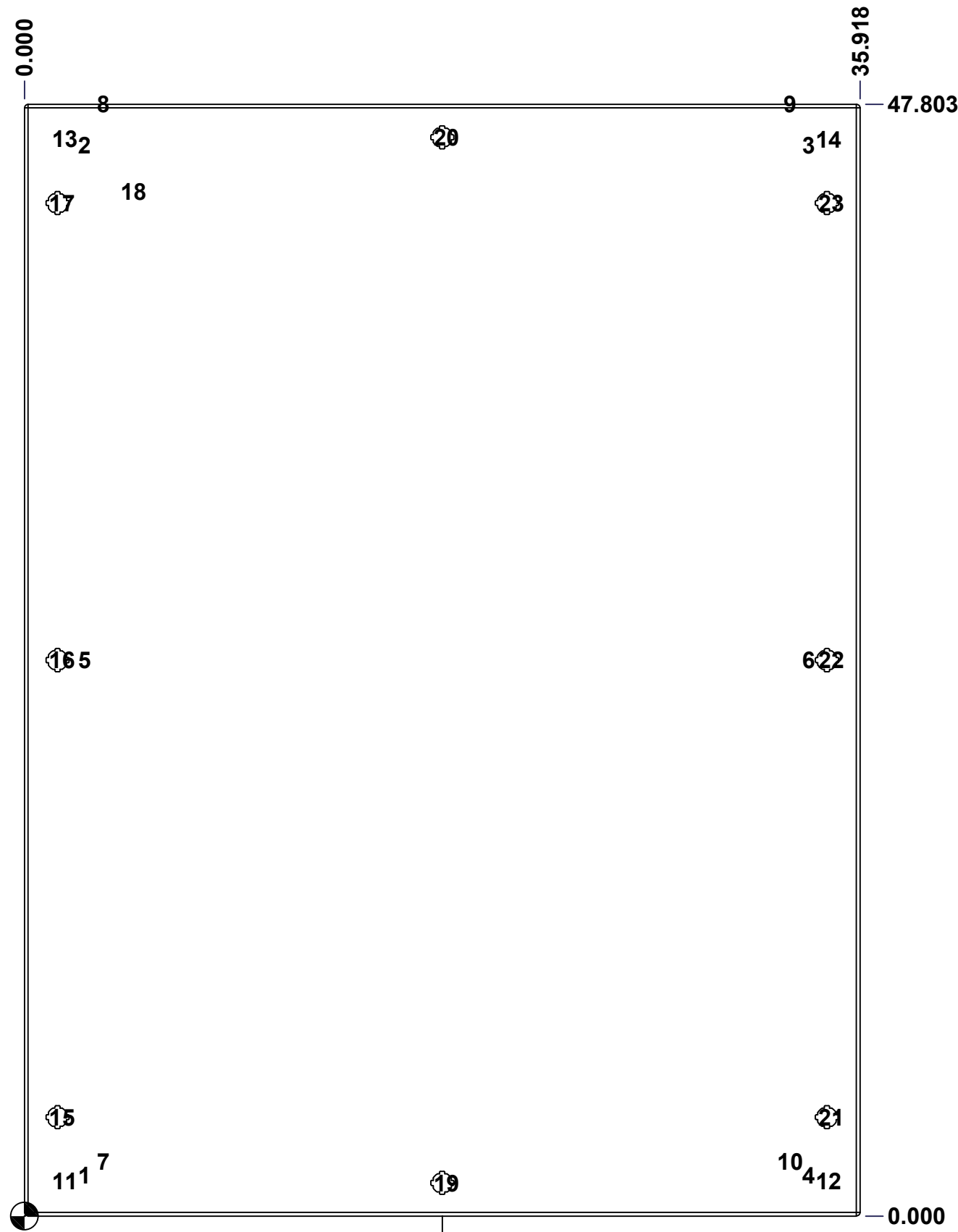

FRONT

	Description	Status
	5412ESSQT 48" x 36" Cover	(NULL)
	Part Number	Rev.
	Numéro Pièce	8
	5412ESSQT4836106C	0
		9

This drawing is confidential and must not be reproduced or used without the consent of EXM

Ce dessin est confidentiel et ne doit pas être reproduit ou utilisé sans le consentement de EXM

No.	Revisions	Date	By/Par

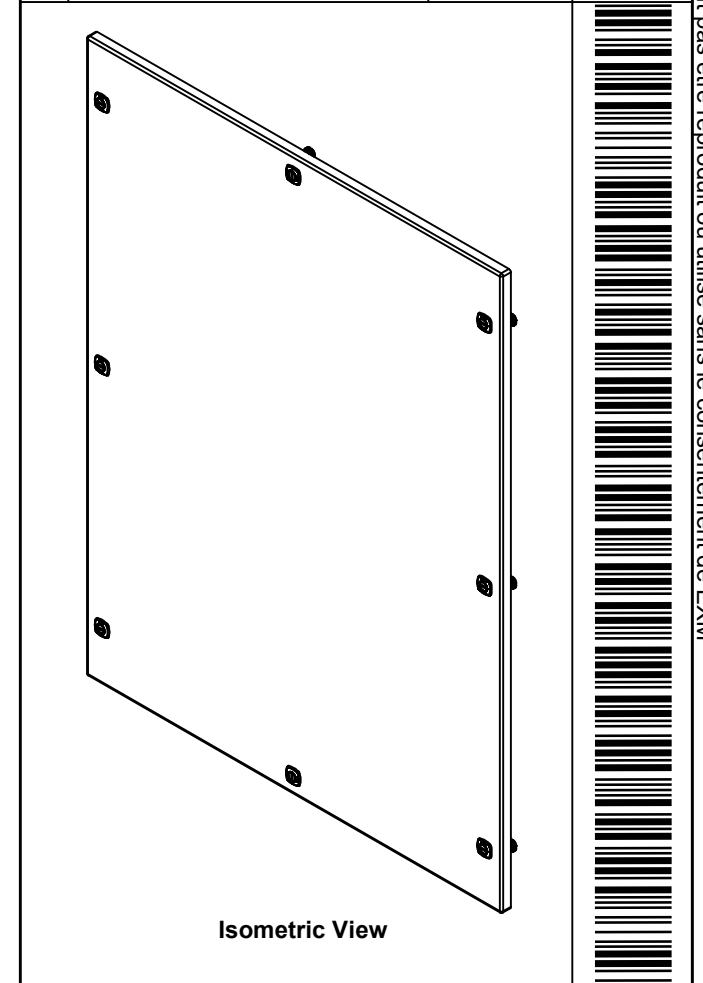

EXM
www.exmweb.com

Tél: (450) 979-4373
Fax: (450) 979-4626

Flatness
Aplatissement
Max 3.0mm

Projection

Customer Client _____ Date _____

Drawn By Dessiné Par BoxCad: BoxCad Date 03-Feb-26

Material Matière 14 Ga Stainless Steel 316 (1.7mm)

Color Couleur Unpainted Finish Fini Brushed

Description 5412ESSQT 48" x 36" Cover Detail Rev. _____

Part Number Numéro Pièce **5412ESSQT4836106C** Rev. **0** 9

QTY	Part Number	Rev	Description
1	STK-S-00100	0	3.5" x 2" Silver Milar Flexcon Sticker
8	STK-K-12590	7	5412 ESS 1/4 Turn Lock
10	STK-Q-07220	1	M6 Nylon Insert Lock Nut
2	STK-Q-46025-36-3	6	5412 ES Horizontal Door Stiffener 36" (3 Pts)
2	STK-Q-46020-48	5	5412 ES Vertical Door Stiffener 48"
14	STK-Q-16070	1	Stud M6 x 18mm Stainless steel
1	5412ESSQT4836106G	0	5412ESSQT 48" x 36" Cover Gasket Part
1	5412ESSQT4836106C-P	0	5412ESSQT 48" x 36" Cover Part
4	STK-Q-46515	3	5412 ES Door Support with Brass Insert
Parts List			

This drawing is confidential and must not be reproduced or used without the consent of EXM

Ce dessin est confidentiel et ne doit pas être reproduit ou utilisé sans le consentement de EXM

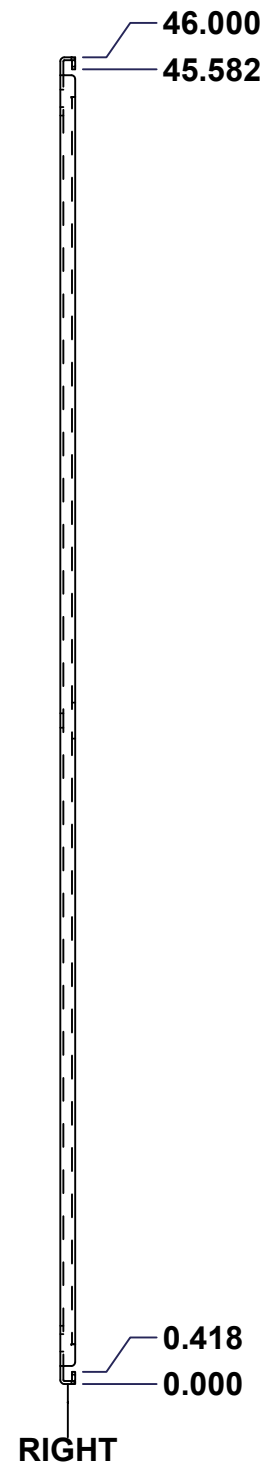
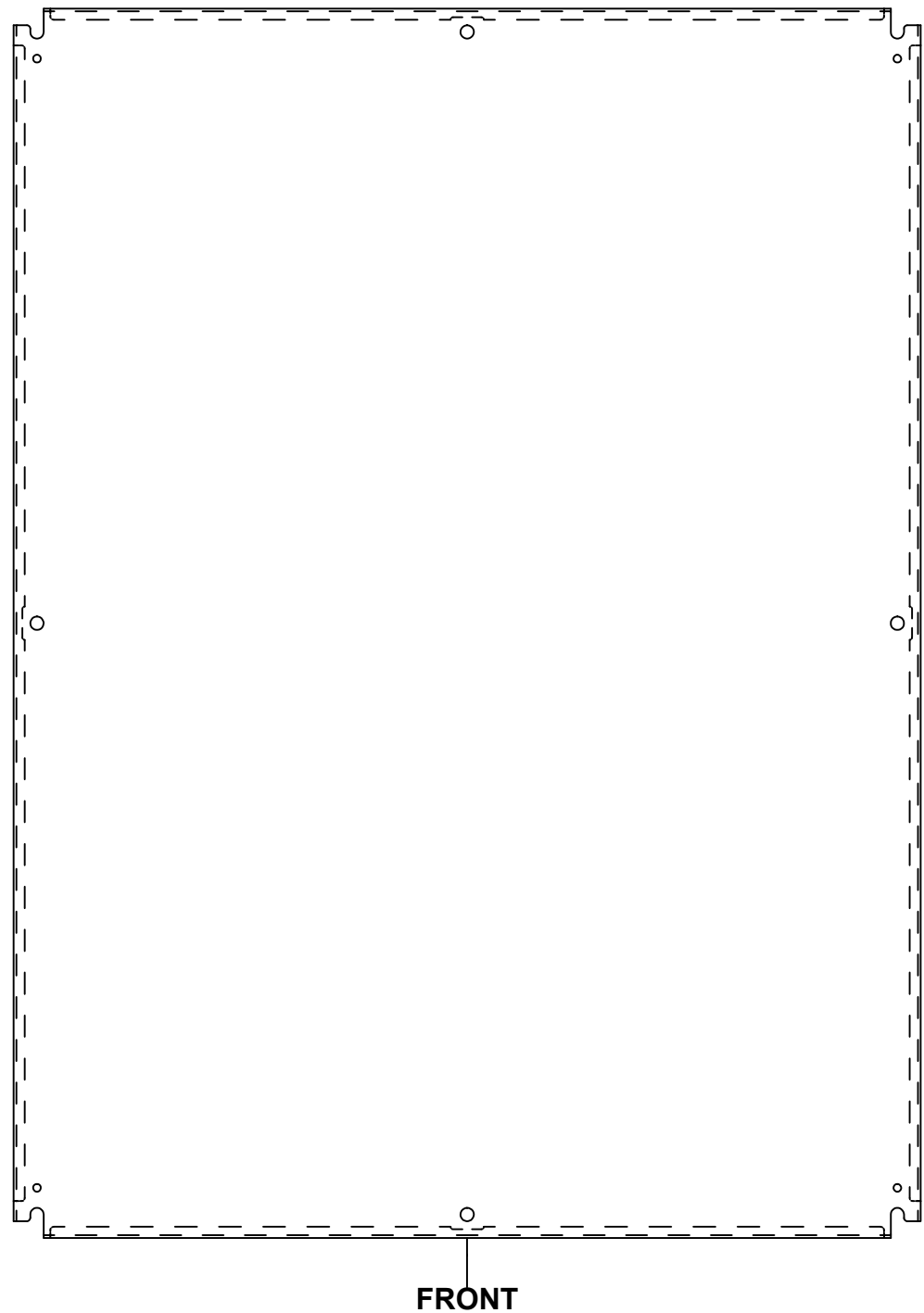
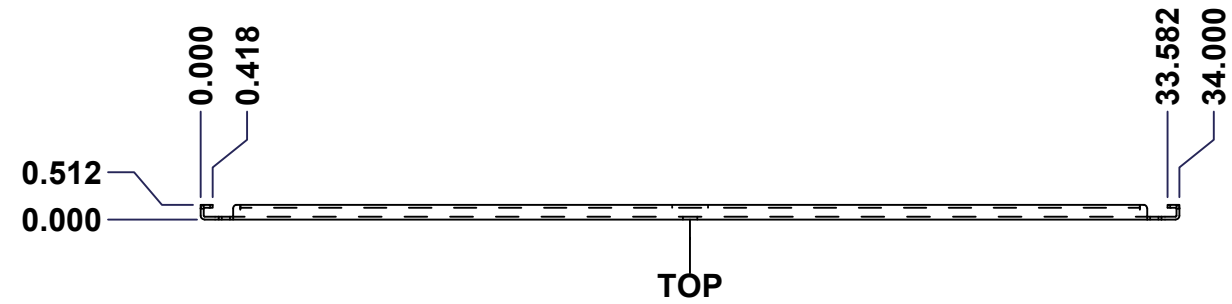

No.	Revisions	Date	By/Par

Isometric View

Tél: (450) 979-4373 Fax: (450) 979-4626 www.exmweb.com		Flatness Aplatissement Max 3.0mm Projection
Customer Client	Date	
Drawn By Dessiné Par	BoxCad	Date 1/23/2007
Material Matière	See Part List	
Color Couleur	See Part List	Finish Fini See Part List
Description		Detail Rev.
881 SP - Inner Panel		
Part Number Numéro Pièce	881 SP4836G	Rev. 1 0

Qty	Part Number	Rev	Description	Material	Color	Finish
1	881 SP4836G-P	0	881 SP - Inner Panel Part	12 Ga Galvanized	Unpainted	Galvanized

Parts List

This drawing is confidential and must not be reproduced or used without the consent of EXM

Ce dessin est confidentiel et ne doit pas être reproduit ou utilisé sans le consentement de EXM

Table 1			FRONT VIEW
CUT-OUT	XDIM	YDIM	DESCRIPTION
1	17.000	0.875	MTG STUD HOLE (RND Ø0.500)
2	0.875	23.000	MTG STUD HOLE (RND Ø0.500)
3	33.125	23.000	MTG STUD HOLE (RND Ø0.500)
4	17.000	45.125	MTG STUD HOLE (RND Ø0.500)
5	0.875	1.875	GROUND HOLE (RND Ø0.290)
6	33.125	1.875	GROUND HOLE (RND Ø0.290)
7	0.875	44.125	GROUND HOLE (RND Ø0.290)
8	33.125	44.125	GROUND HOLE (RND Ø0.290)

All knockouts are actual size / Les disques défonçables sont grandeur réel

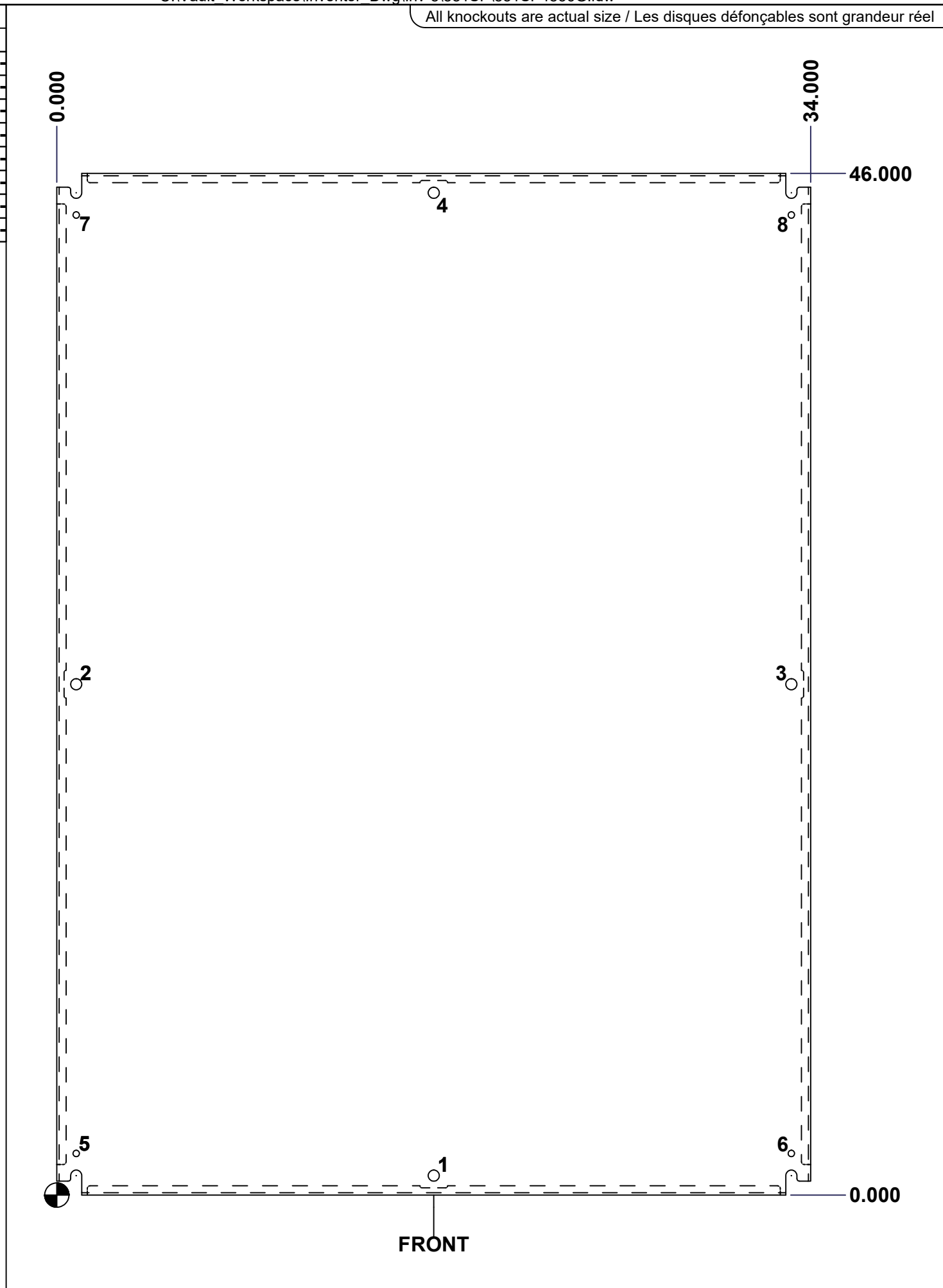

No.	Revisions	Date	By/Par

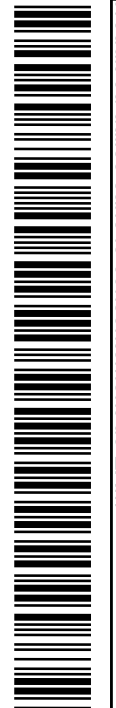
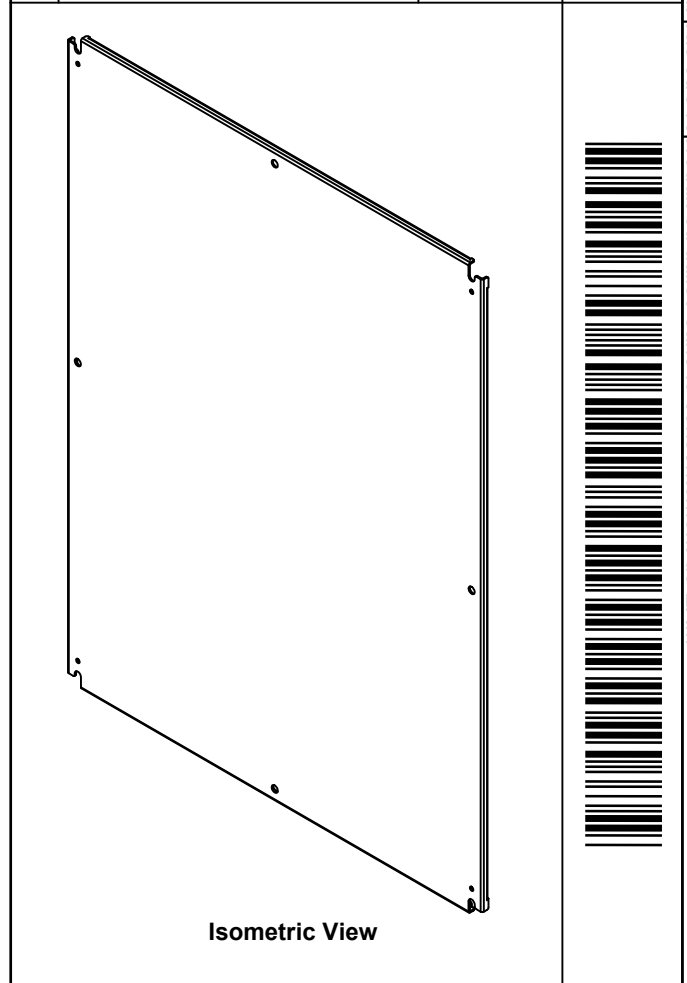

		Tél: (450) 979-4373 Fax: (450) 979-4626 www.exmweb.com		Flatness Aplatissement Max 3.0mm	
Customer Client		Date		Projection 	
Drawn By Dessiné Par		BoxCad		Date 1/23/2007	
Material Matière		See Part List			
Color Couleur		See Part List		Finish Fini See Part List	
Description 881 SP - Inner Panel				Detail Rev.	
Part Number Numéro Pièce 881 SP4836G				Rev. 2 0	