

This drawing is confidential and must not be reproduced or used without the consent of EXM

Ce dessin est confidentiel et ne doit pas être reproduit ou utilisé sans le consentement de EXM

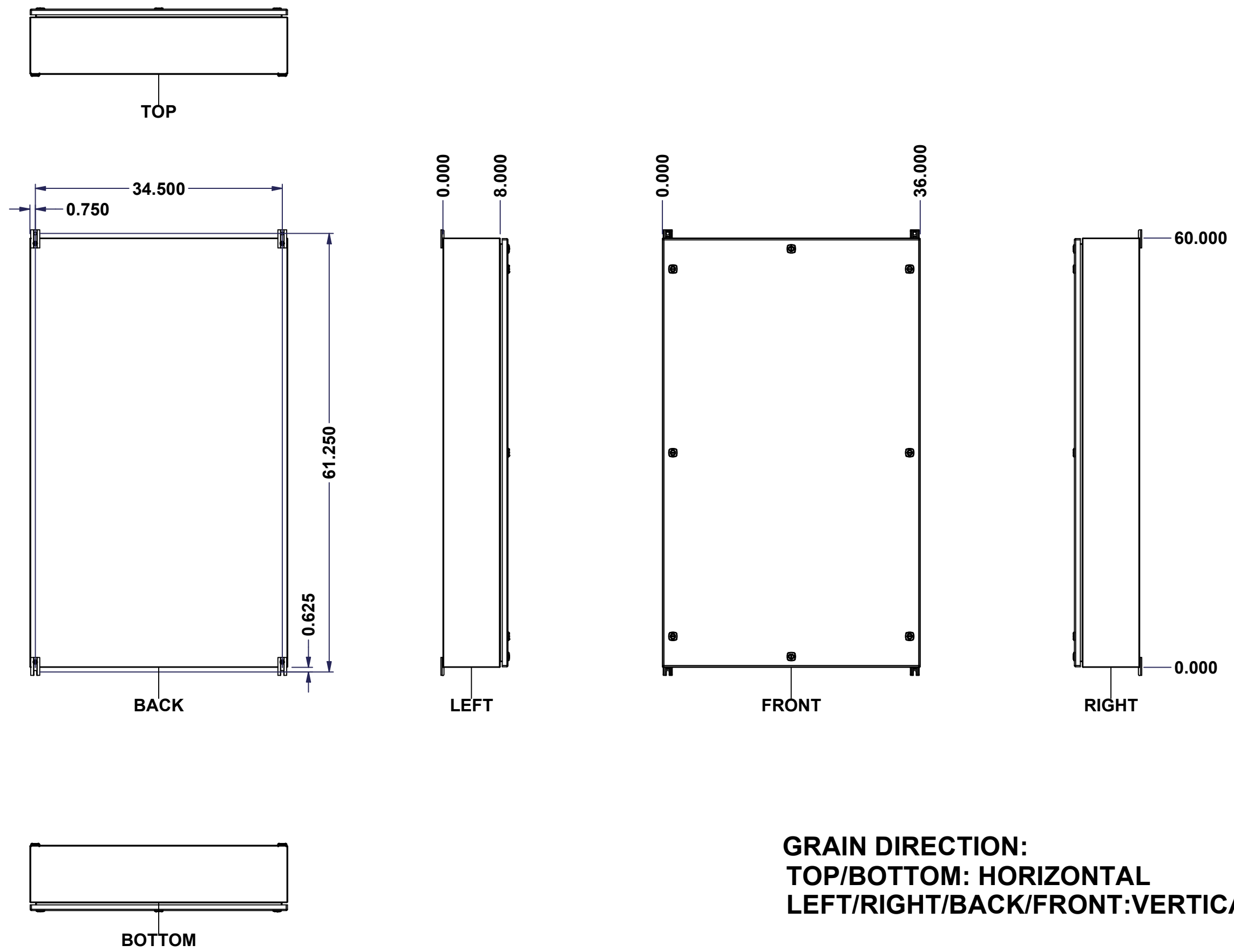

No.	Revisions	Date	By/Par

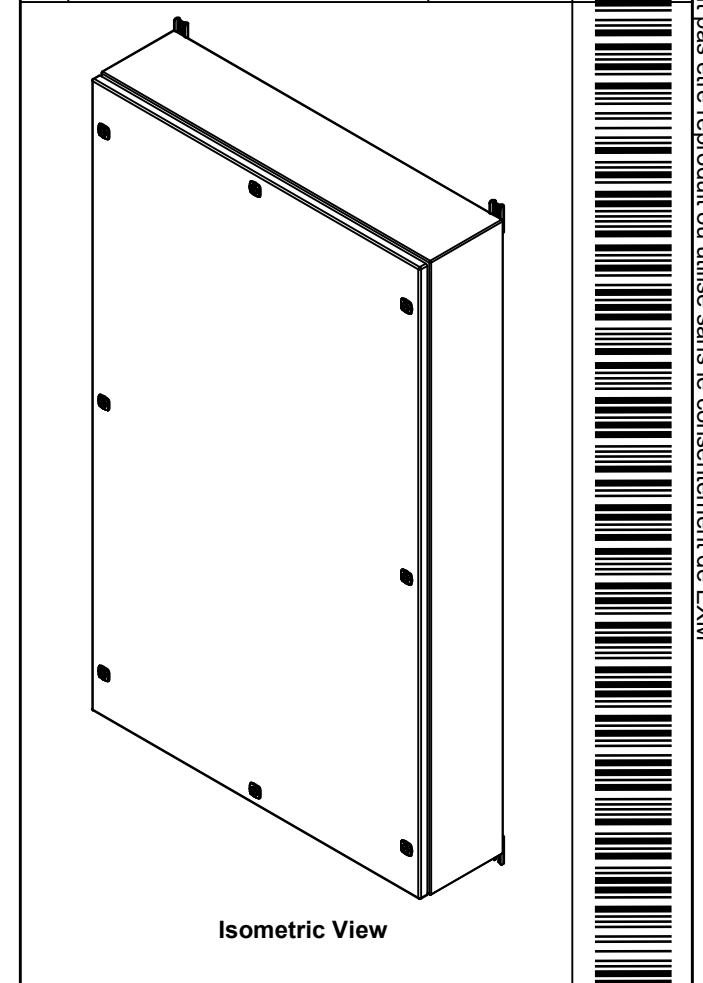

**GRAIN DIRECTION:  
TOP/BOTTOM: HORIZONTAL  
LEFT/RIGHT/BACK/FRONT: VERTICAL**

		Flatness Aplatissement Max 3.0mm Projection 	
Tél: (450) 979-4373 Fax: (450) 979-4626 <a href="http://www.exmweb.com">www.exmweb.com</a>		Date Date 25-Feb-26	
Customer Client		Date	
Drawn By Dessiné Par BoxCad: BoxCad		Date 25-Feb-26	
Material Matière 14 Ga Stainless Steel 316 (1.7mm)		Finish Fini Brushed	
Color Couleur Unpainted		Finish Fini Brushed	
Description 5412ESSQT 60" x 36" x 8" Assembly		Detail Rev.	
Part Number Numéro Pièce 5412ESSQT6036086TH		Rev. 0	1 16

SEE BILL OF MATERIAL ON LAST PAGE

This drawing is confidential and must not be reproduced or used without the consent of EXM

Ce dessin est confidentiel et ne doit pas être reproduit ou utilisé sans le consentement de EXM

NOTE	
ITEM	DESCRIPTION
1	NEMA 4X Enclosure (IP66)
2	C/W Standard ground studs on box and cover
3	C/W Standard door stiffener
4	C/W Standard inner panel (Included)
5	C/W Standard inner panel mounting studs
6	C/W 885 ESMF4_OPEN Sold separately (Installed)
7	C/W 885 ESMF4_CLOSE Sold separately (Installed)
8	C/W R5 Insulation (Installed aluminum visible)

No.	Revisions	Date	By/Par

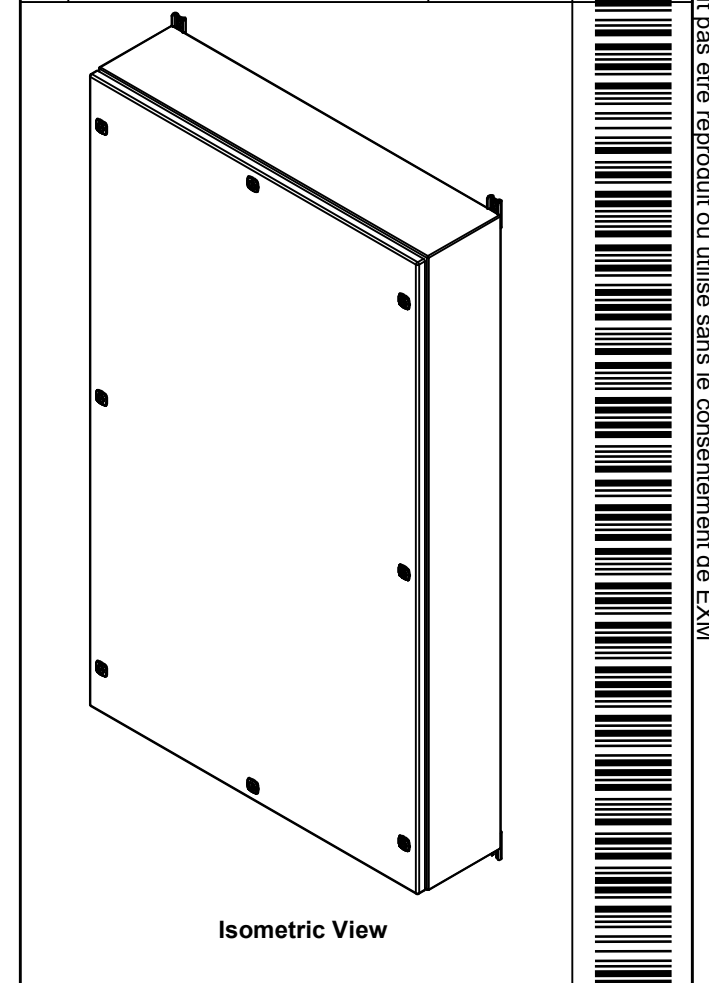

PACKING		
ITEM	QTY	DESCRIPTION
Cardboard sleeve	2	Top and Bottom
Cardboard strip	2	Between back of enclosure and inner panel
Plastic bag	1	To protect cover surface and inside gasket
Cardboard corner	4	To reinforced for the plastic strap tightening
Plastic strap - Black	2	To Squeeze the 2 cardboard sleeve together
Packaging label	3	White label with PN
Plastic strap- Green	2	To secure the enclosure to the wood pallet
Wood Pallet	1	2" deeper and 3" larger than enclosure size

1	STK-K-01800	5	5412 ES Accessory Kit
8	STK-Q-00600	2	M12 to M8 Adaptor
1	881 SP6036G	0	881 SP - Inner Panel
1	5412ESSQT6036086THC	0	5412ESSQT 60" x 36" Cover
1	5412ESSQT6036086THB	0	5412ESSQT 60" x 36" x 8" Body
Qty	Part Number	Rev	Description
Parts List			

	Flatness Aplatissement Max 3.0mm
	Projection 
Customer Client Drawn By / Dessiné Par: BoxCad: BoxCad	Date: 25-Feb-26
Material / Matière: 14 Ga Stainless Steel 316 (1.7mm)	Color / Couleur: Unpainted Finish / Fini: Brushed
Description: 5412ESSQT 60" x 36" x 8" Assembly	Detail Rev.
Part Number / Numéro Pièce: <b>5412ESSQT6036086TH</b>	Rev. 0 / 2

This drawing is confidential and must not be reproduced or used without the consent of EXM

Ce dessin est confidentiel et ne doit pas être reproduit ou utilisé sans le consentement de EXM

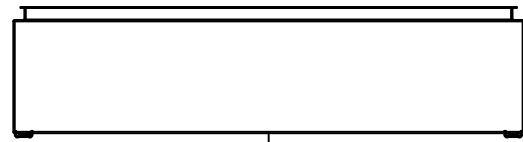

TOP

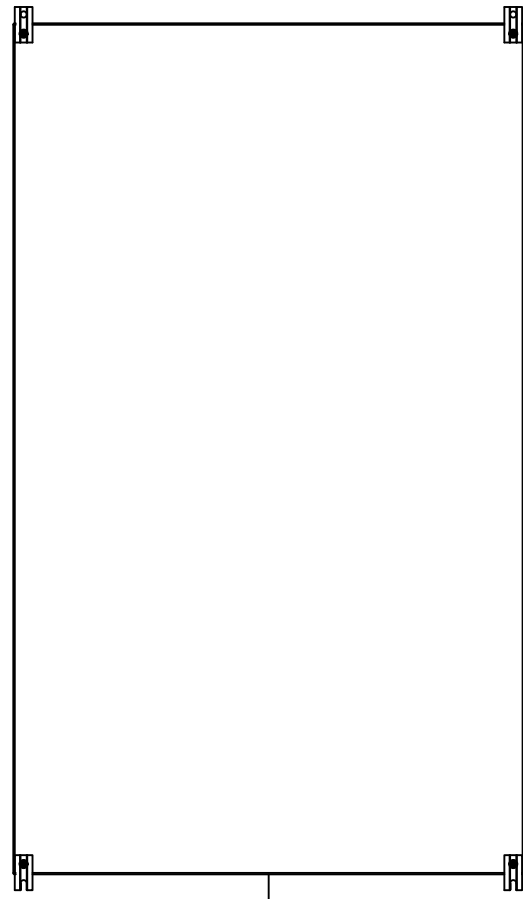

BACK

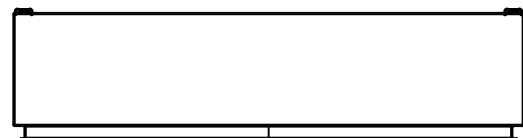

BOTTOM

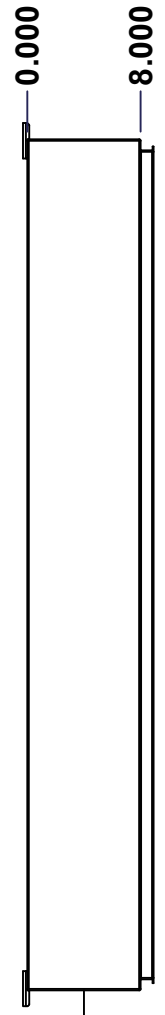

LEFT

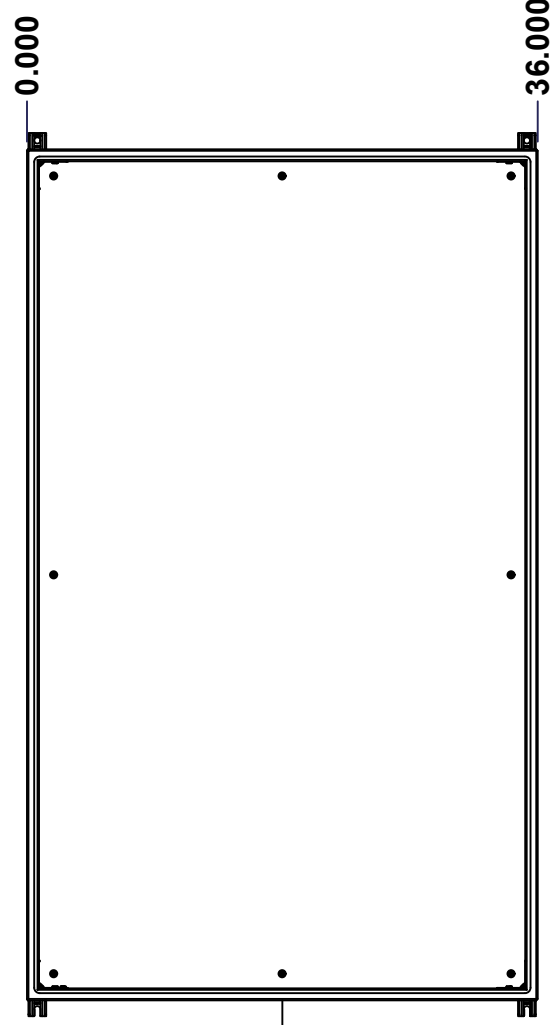

FRONT

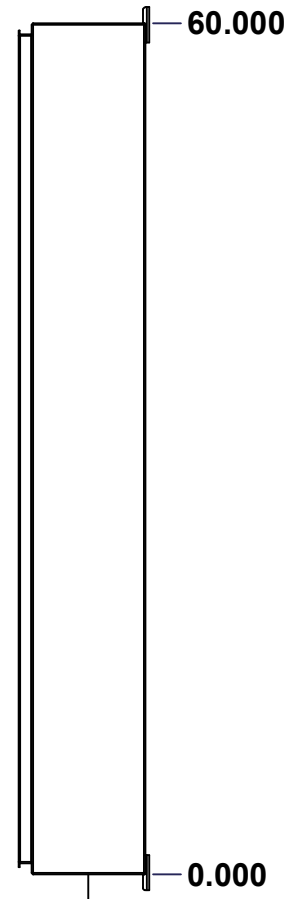

RIGHT

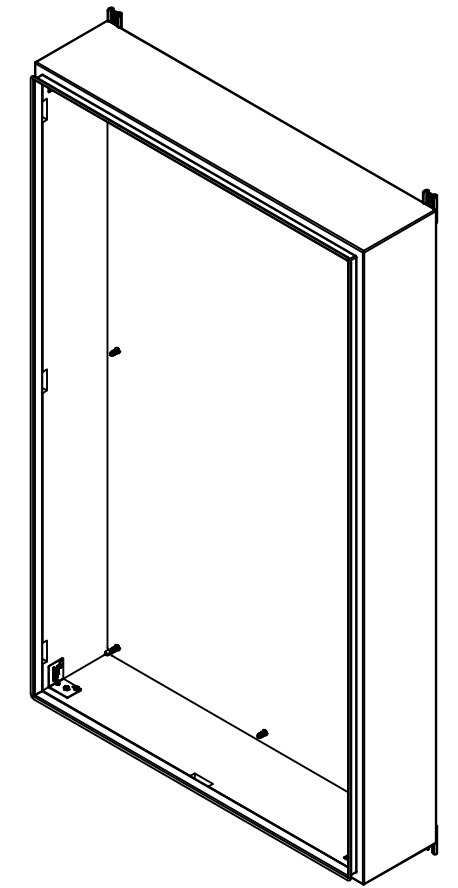

Isometric View

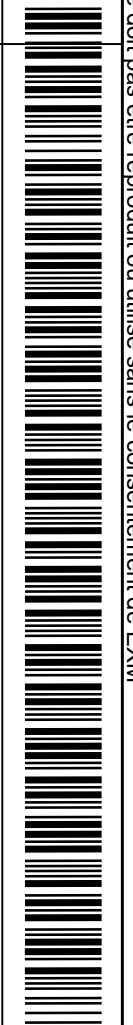

No.	Revisions	Date	By/Par

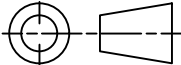
 Tél: (450) 979-4373 Fax: (450) 979-4626 <a href="http://www.exmweb.com">www.exmweb.com</a>		Flatness Aplatissement Max 3.0mm Projection 
Customer Client	Date	
Drawn By Dessiné Par	BoxCad: BoxCad	Date 25-Feb-26
Material Matière	14 Ga Stainless Steel 316 (1.7mm)	
Color Couleur	Unpainted	Finish Fini Brushed
Description	Detail Rev.	
5412ESSQT 60" x 36" x 8" Body		
Part Number Numéro Pièce	Rev.	3
SEE BILL OF MATERIAL ON LAST PAGE	0	16

SEE BILL OF MATERIAL ON LAST PAGE **5412ESSQT6036086THB**

This drawing is confidential and must not be reproduced or used without the consent of EXM

Ce dessin est confidentiel et ne doit pas être reproduit ou utilisé sans le consentement de EXM

STANDARD FEATURES ARE NOT LISTED IN THIS HOLE TABLE			
HOLE TABLE - TOP VIEW (CUSTOM FEATURE ONLY)			
CUT-OUT	XDIM	YDIM	DESCRIPTION
1	1.500	7.250	INSUL. STUD M6 x 18mm (Inside)
2	34.500	7.250	INSUL. STUD M6 x 18mm (Inside)

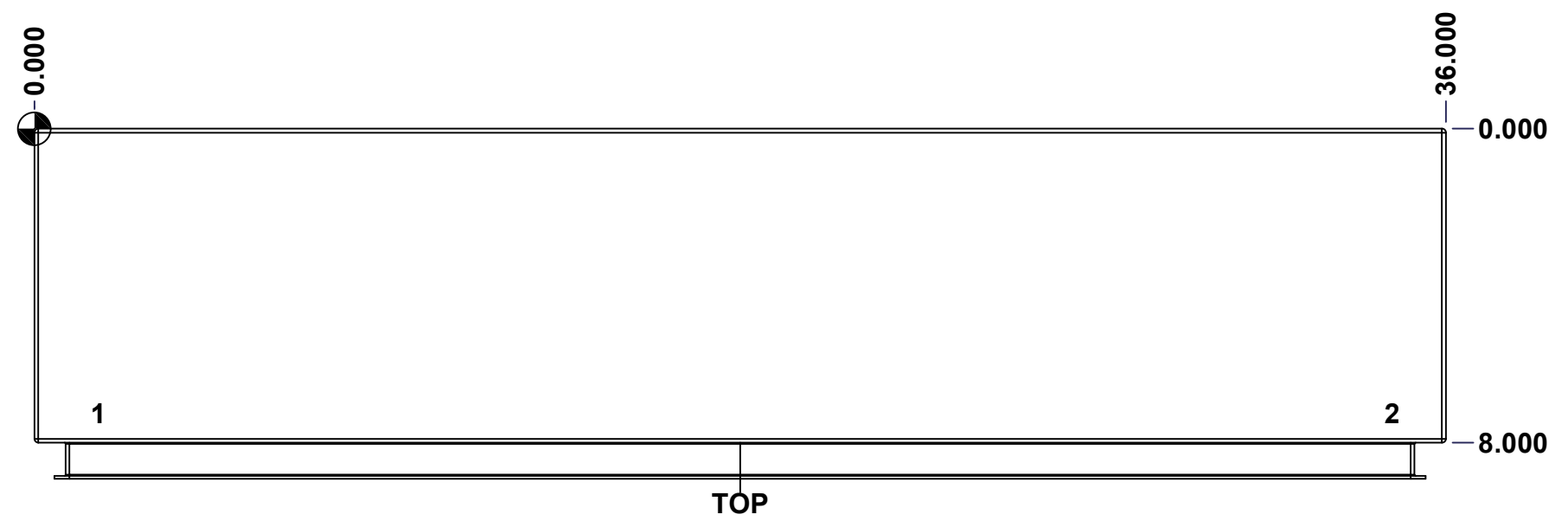

	Description	Status
	5412ESSQT 60" x 36" x 8" Body	(NULL)
	Part Number Numéro Pièce	Rev.
	<b>5412ESSQT6036086THB</b>	<b>0</b>
		4
		16

This drawing is confidential and must not be reproduced or used without the consent of EXM

Ce dessin est confidentiel et ne doit pas être reproduit ou utilisé sans le consentement de EXM

<b>STANDARD FEATURES ARE NOT LISTED IN THIS HOLE TABLE</b>			
<b>HOLE TABLE - BOTTOM VIEW (CUSTOM FEATURE ONLY)</b>			
CUT-OUT	XDIM	YDIM	DESCRIPTION
1	2.000	6.500	INSUL. STUD M6 x 18mm (Inside)
2	34.000	6.500	INSUL. STUD M6 x 18mm (Inside)

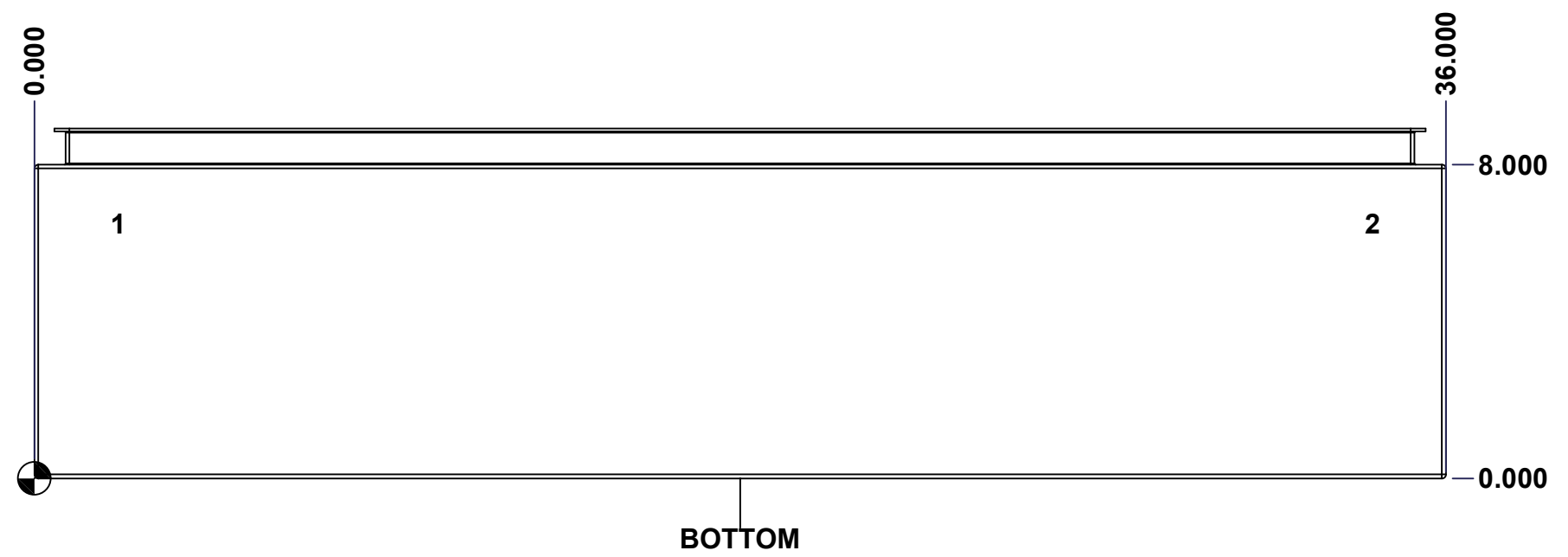

	Description	Status
	5412ESSQT 60" x 36" x 8" Body	(NULL)
	Part Number Numéro Pièce	Rev.
	<b>5412ESSQT6036086THB</b>	<b>0</b> / 5
		16

This drawing is confidential and must not be reproduced or used without the consent of EXM

Ce dessin est confidentiel et ne doit pas être reproduit ou utilisé sans le consentement de EXM

**STANDARD FEATURES ARE NOT LISTED IN THIS HOLE TABLE**

**HOLE TABLE - BACK VIEW (CUSTOM FEATURE ONLY)**

CUT-OUT	XDIM	YDIM	DESCRIPTION
1	1.875	1.875	IP STUD M8 x 35mm (Inside)
2	1.875	58.125	IP STUD M8 x 35mm (Inside)
3	34.125	58.125	IP STUD M8 x 35mm (Inside)
4	34.125	1.875	IP STUD M8 x 35mm (Inside)
5	18.000	1.875	IP STUD M8 x 35mm (Inside)
6	18.000	58.125	IP STUD M8 x 35mm (Inside)
7	1.875	30.000	IP STUD M8 x 35mm (Inside)
8	34.125	30.000	IP STUD M8 x 35mm (Inside)
-----			
9	0.750	0.000	FOOT 885 ESMF4_OPEN
10	0.750	60.000	FOOT 885 ESMF4_CLOSE
11	35.250	0.000	FOOT 885 ESMF4_OPEN
12	35.250	60.000	FOOT 885 ESMF4_CLOSE

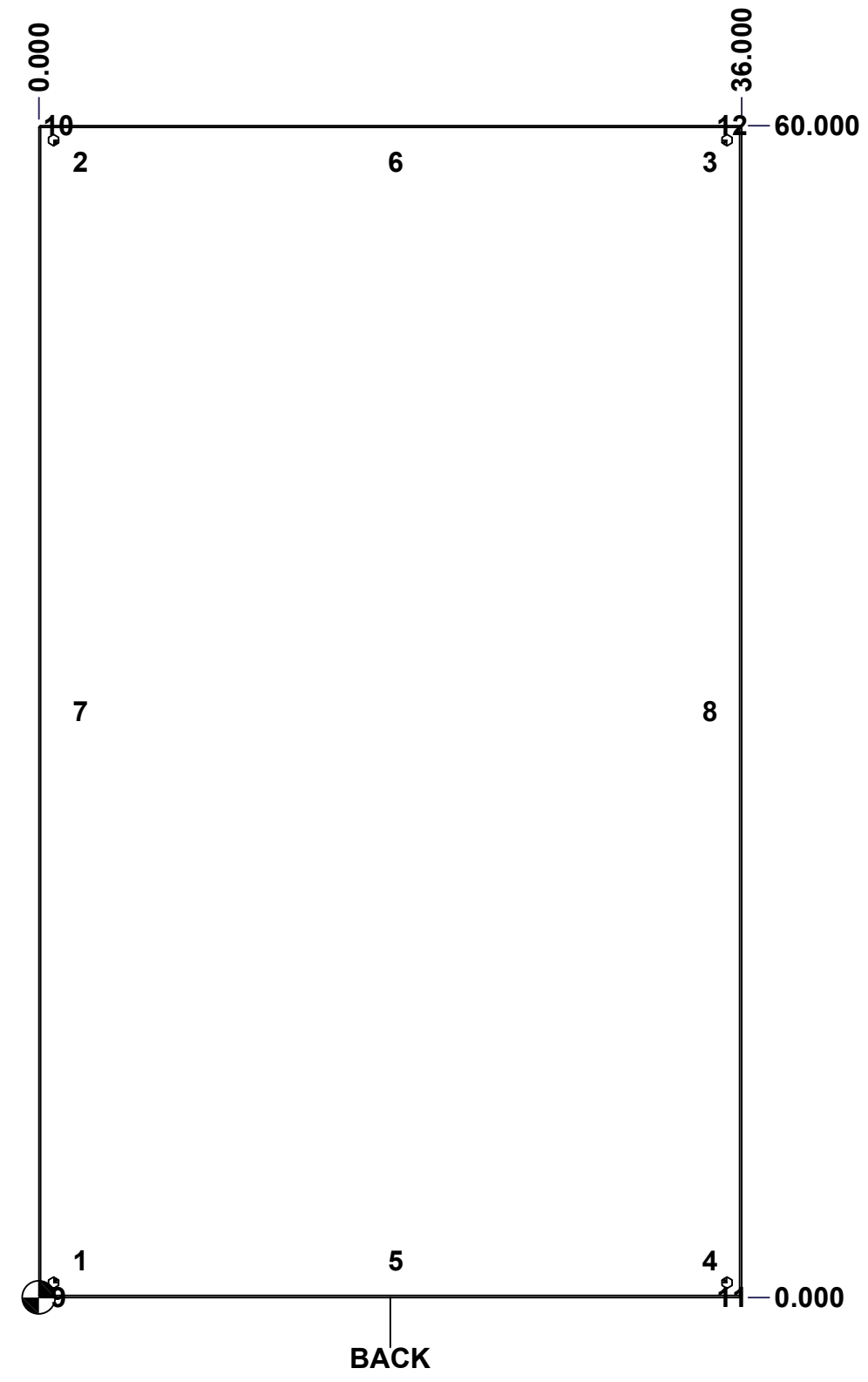

	Description	Status
	5412ESSQT 60" x 36" x 8" Body	(NULL)
	Part Number Numéro Pièce	Rev.
	<b>5412ESSQT6036086THB</b>	<b>0</b> / 6
		16

This drawing is confidential and must not be reproduced or used without the consent of EXM

Ce dessin est confidentiel et ne doit pas être reproduit ou utilisé sans le consentement de EXM

No.	Revisions	Date	By/Par

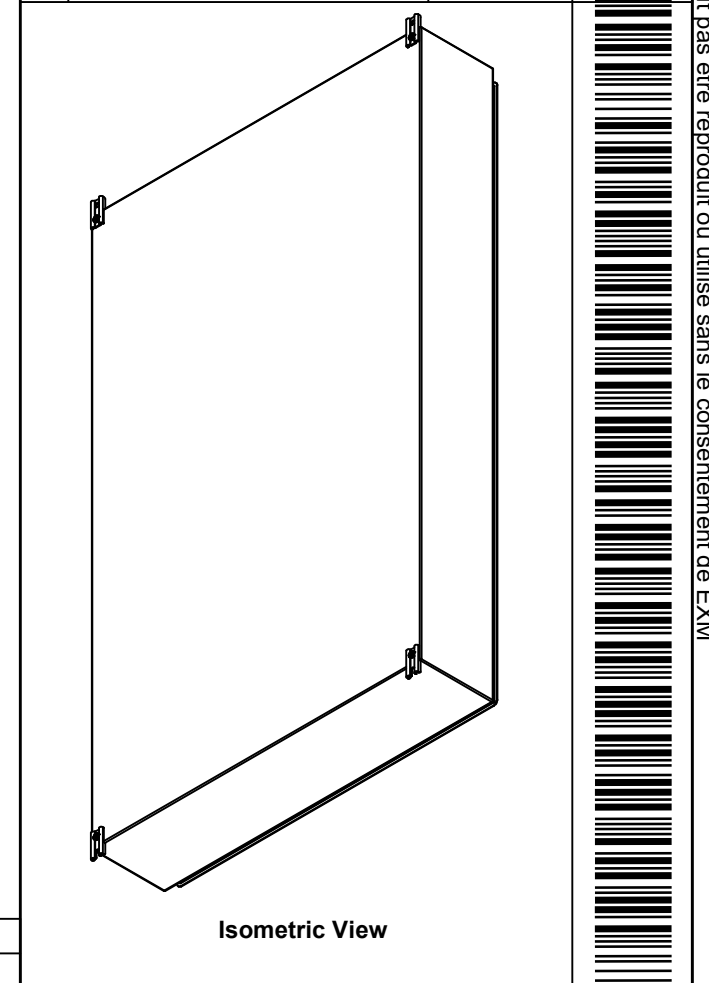

1	885 ESMF4	0	885 ESMF4 Mounting Foot Kit
1	STK-K-70554	3	5412 ESTH Accessory Kit
1	5412ESSQT6036086TH-RS	0	5412ESSQT 60" x 36" Right Insulation
1	5412ESSQT6036086TH-LS	0	5412ESSQT 60" x 36" Left Insulation
1	5412ESSQT6036086TH-BT	0	5412ESSQT 60" x 36"Bottom Insulation
1	5412ESSQT6036086TH-TP	0	5412ESSQT 60" x 36"Top Insulation
1	5412ESSQT6036086TH-B	0	5412ESSQT 60" x 36" Back Insulation
4	STK-Q-16070	1	Stud M6 x 18mm Stainless steel
4	RIVET_NUT_SS_M10_FH_CE	0	Stainless Steel Rivet Nut M10 (Low Profile Close End)
8	STK-Q-16020	1	Stud M8 x 35mm Stainless Steel
1	5412ESSQT6036086THB-P	0	5412ESSQT 60" x 36" x 8" Body Part
Qty	Part Number	Rev	Description
Parts List			

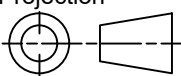
 Tél: (450) 979-4373 Fax: (450) 979-4626 <a href="http://www.exmweb.com">www.exmweb.com</a>		Flatness Aplatissement Max 3.0mm Projection 
Customer Client	Date	
Drawn By Dessiné Par	BoxCad: BoxCad	Date 25-Feb-26
Material Matière	14 Ga Stainless Steel 316 (1.7mm)	
Color Couleur	Unpainted	Finish Fini Brushed
Description	Detail Rev.	
5412ESSQT 60" x 36" x 8" Body		
Part Number Numéro Pièce	Rev.	7
<b>5412ESSQT6036086THB</b>	<b>0</b>	16

This drawing is confidential and must not be reproduced or used without the consent of EXM

Ce dessin est confidentiel et ne doit pas être reproduit ou utilisé sans le consentement de EXM

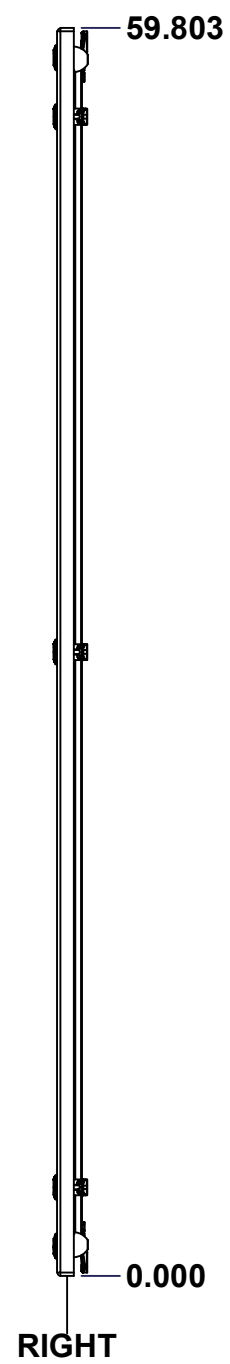
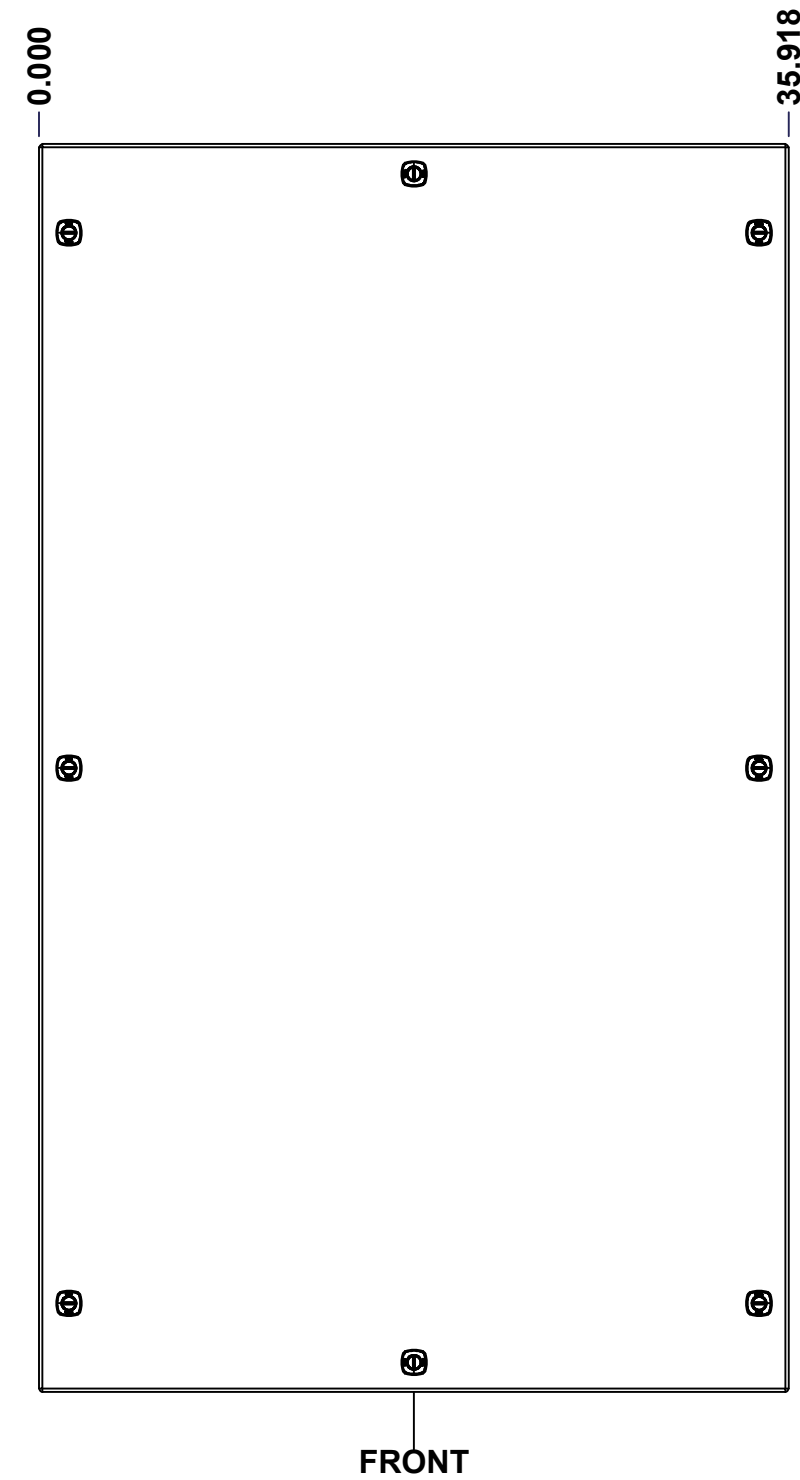
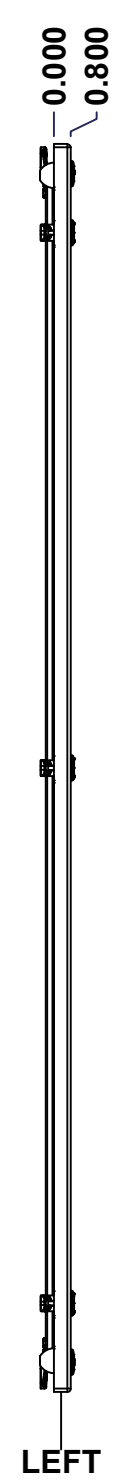
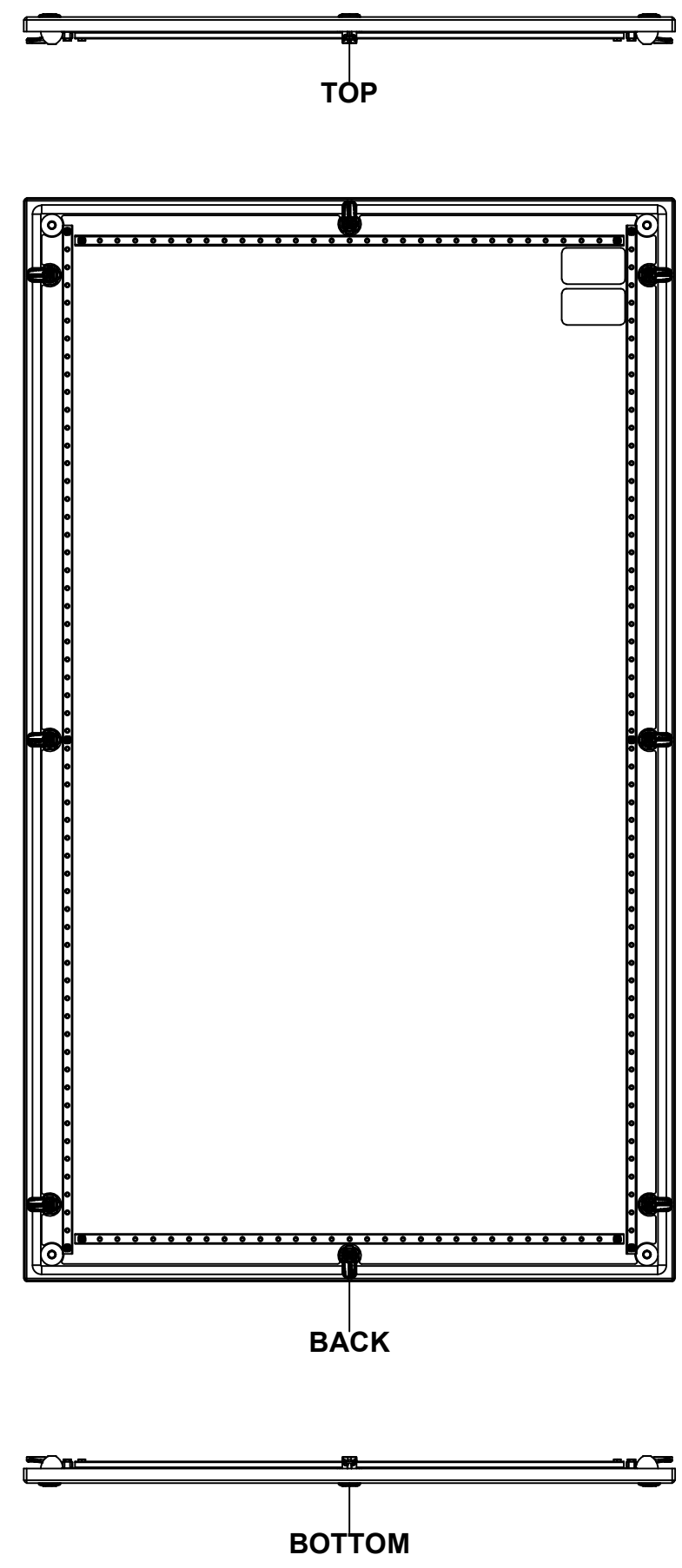

No.	Revisions	Date	By/Par

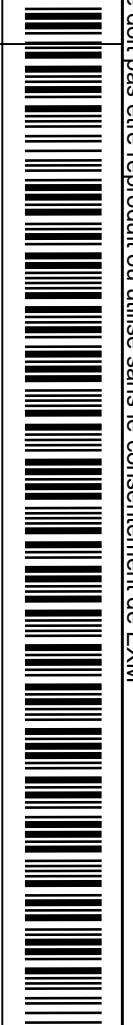
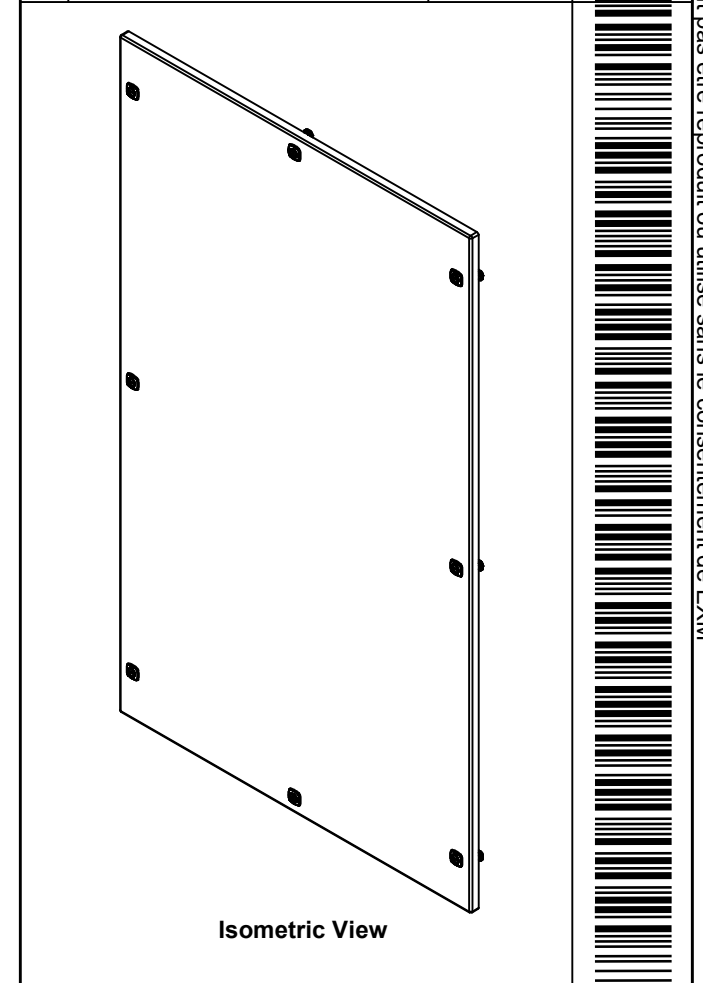

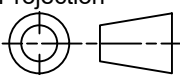
 Tél: (450) 979-4373 Fax: (450) 979-4626 <a href="http://www.exmweb.com">www.exmweb.com</a>		Flatness Aplatissement Max 3.0mm Projection 
Customer Client	Date	
Drawn By Dessiné Par	BoxCad: BoxCad	Date 25-Feb-26
Material Matière	14 Ga Stainless Steel 316 (1.7mm)	
Color Couleur	Unpainted	Finish Fini Brushed
Description 5412ESSQT 60" x 36" Cover		Detail Rev.
Part Number Numéro Pièce	Rev. 0	8 / 16

SEE BILL OF MATERIAL ON LAST PAGE **5412ESSQT6036086THC**

This drawing is confidential and must not be reproduced or used without the consent of EXM

Ce dessin est confidentiel et ne doit pas être reproduit ou utilisé sans le consentement de EXM

**STANDARD FEATURES ARE NOT LISTED IN THIS HOLE TABLE**

**HOLE TABLE - FRONT VIEW (CUSTOM FEATURE ONLY)**

CUT-OUT	XDIM	YDIM	DESCRIPTION
1	2.401	1.850	STUD M6 x 18mm (Inside)
2	2.401	57.953	STUD M6 x 18mm (Inside)
3	33.517	57.953	STUD M6 x 18mm (Inside)
4	33.517	1.850	STUD M6 x 18mm (Inside)
5	2.401	29.902	STUD M6 x 18mm (Inside)
6	33.517	29.902	STUD M6 x 18mm (Inside)
7	3.195	2.350	STUD M6 x 18mm (Inside)
8	3.195	59.803	STUD M6 x 18mm (Inside)
9	32.723	59.803	STUD M6 x 18mm (Inside)
10	32.723	2.350	STUD M6 x 18mm (Inside)
11	1.550	1.500	STUD M6 x 18mm (Inside)
12	34.368	1.500	STUD M6 x 18mm (Inside)
13	1.550	58.303	STUD M6 x 18mm (Inside)
14	34.368	58.303	STUD M6 x 18mm (Inside)
-----			
15	1.424	4.250	LOCK 880 SCQ4-SLSS6 @ 180.0°
16	1.424	29.902	LOCK 880 SCQ4-SLSS6 @ 180.0°
17	1.424	55.553	LOCK 880 SCQ4-SLSS6 @ 180.0°
18	17.959	1.424	LOCK 880 SCQ4-SLSS6 @ 270.0°
19	17.959	58.379	LOCK 880 SCQ4-SLSS6 @ 90.0°
20	34.494	4.250	LOCK 880 SCQ4-SLSS6 @ 0.0°
21	34.494	29.902	LOCK 880 SCQ4-SLSS6 @ 0.0°
22	34.494	55.553	LOCK 880 SCQ4-SLSS6 @ 0.0°

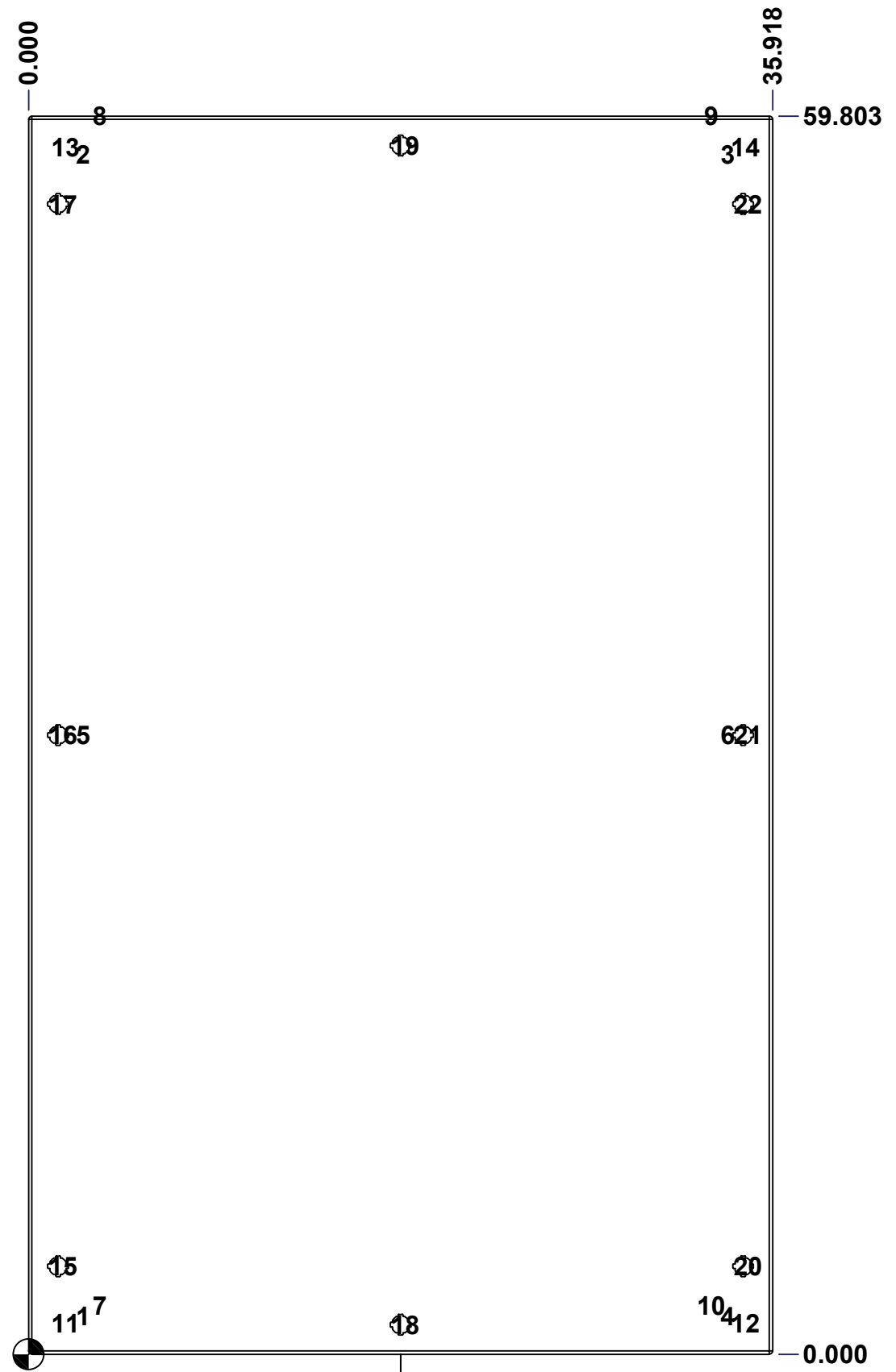

FRONT

	Description	Status
	5412ESSQT 60" x 36" Cover	(NULL)
	Part Number Numéro Pièce	Rev.
	<b>5412ESSQT6036086THC</b>	<b>0</b> / 9
		16

This drawing is confidential and must not be reproduced or used without the consent of EXM

Ce dessin est confidentiel et ne doit pas être reproduit ou utilisé sans le consentement de EXM

No.	Revisions	Date	By/Par

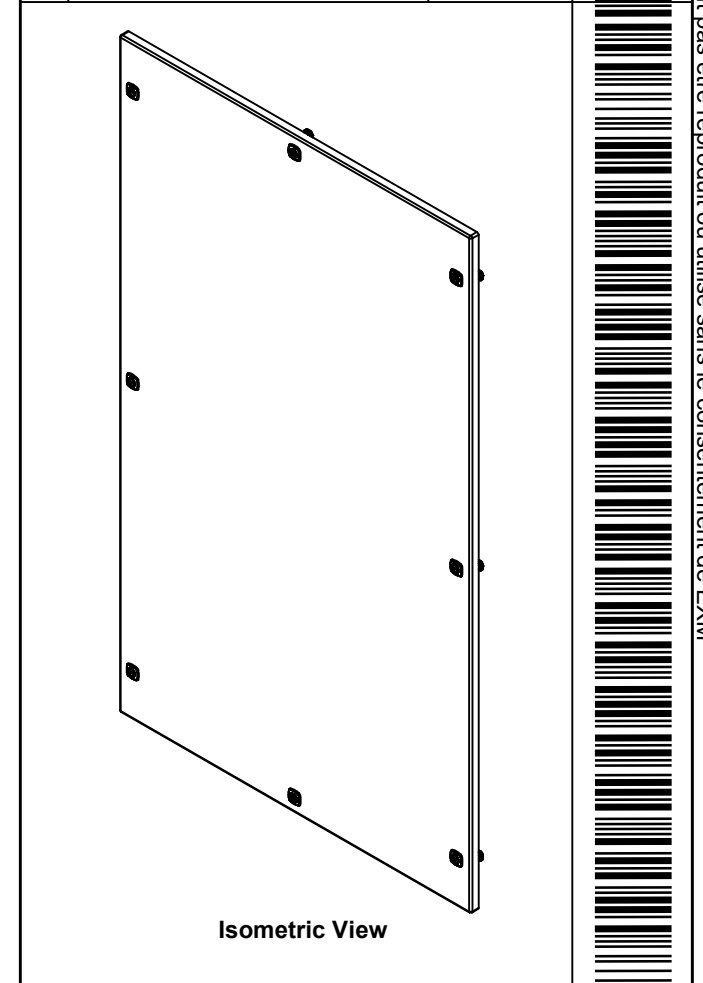

2	STK-Q-46025-36-3	6	5412 ES Horizontal Door Stiffener 36" (3 Pts)
10	STK-Q-07250	2	M6 x 16mm Collar Nut
2	STK-Q-46020-60	5	5412 ES Vertical Door Stiffener 60"
2	STK-S-00100	0	3.5" x 2" Silver Milar Flexcon Sticker
1	5412ESSQT6036086THI-C	0	5412ESSQT 60" x 36" Cover Insulation
8	STK-K-12590	7	5412 ESS 1/4 Turn Lock
14	STK-Q-16070	1	Stud M6 x 18mm Stainless steel
1	5412ESSQT6036086THG	0	5412ESSQT 60" x 36" Cover Gasket Part
1	5412ESSQT6036086THC-P	0	5412ESSQT 60" x 36" Cover Part
4	STK-Q-46515	3	5412 ES Door Support with Brass Insert
QTY	Part Number	Rev	Description
Parts List			

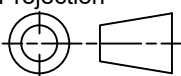
 Tél: (450) 979-4373 Fax: (450) 979-4626 <a href="http://www.exmweb.com">www.exmweb.com</a>		Flatness Aplatissement Max 3.0mm Projection 
Customer Client	Date	
Drawn By Dessiné Par	BoxCad: BoxCad	Date 25-Feb-26
Material Matière	14 Ga Stainless Steel 316 (1.7mm)	
Color Couleur	Unpainted	Finish Fini Brushed
Description		Detail Rev.
5412ESSQT 60" x 36" Cover		
Part Number Numéro Pièce	Rev.	10
<b>5412ESSQT6036086THC</b>	<b>0</b>	16

This drawing is confidential and must not be reproduced or used without the consent of EXM

Ce dessin est confidentiel et ne doit pas être reproduit ou utilisé sans le consentement de EXM

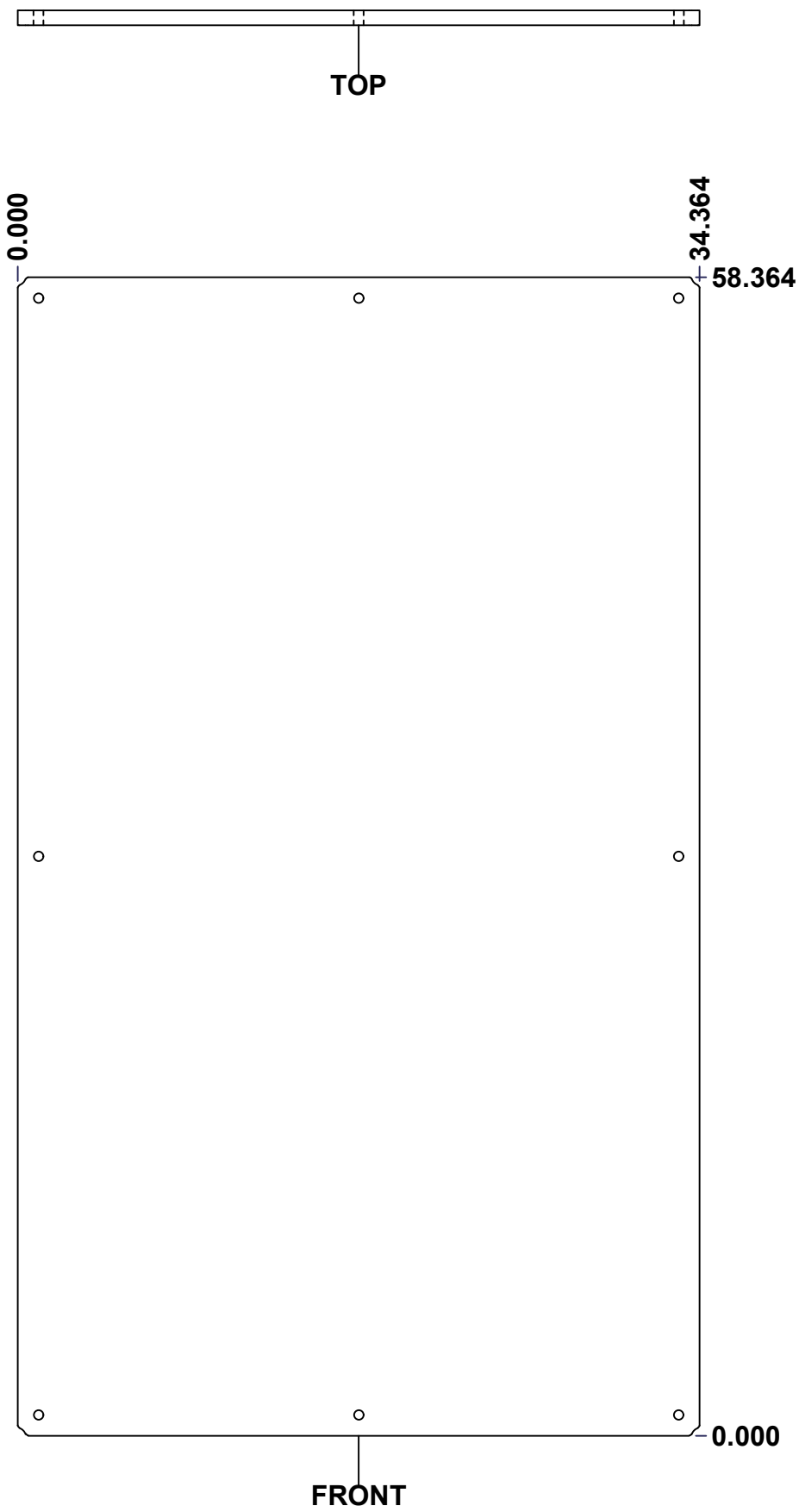

No.	Revisions	Date	By/Par

**Isometric View**

<p>Tél: (450) 979-4373 Fax: (450) 979-4626 <a href="http://www.exmweb.com">www.exmweb.com</a></p>		Flatness Aplatissement	
		Max 3.0mm	
Customer Client		Date	
Drawn By Dessiné Par		Date	
Material Matière		Polyisocyanurate	
Color Couleur		Aluminum	Finish Fini
Description		Detail Rev.	
Part Number Numéro Pièce		Rev.	11
SEE BILL OF MATERIAL ON LAST PAGE		0	16

This drawing is confidential and must not be reproduced or used without the consent of EXM

Ce dessin est confidentiel et ne doit pas être reproduit ou utilisé sans le consentement de EXM

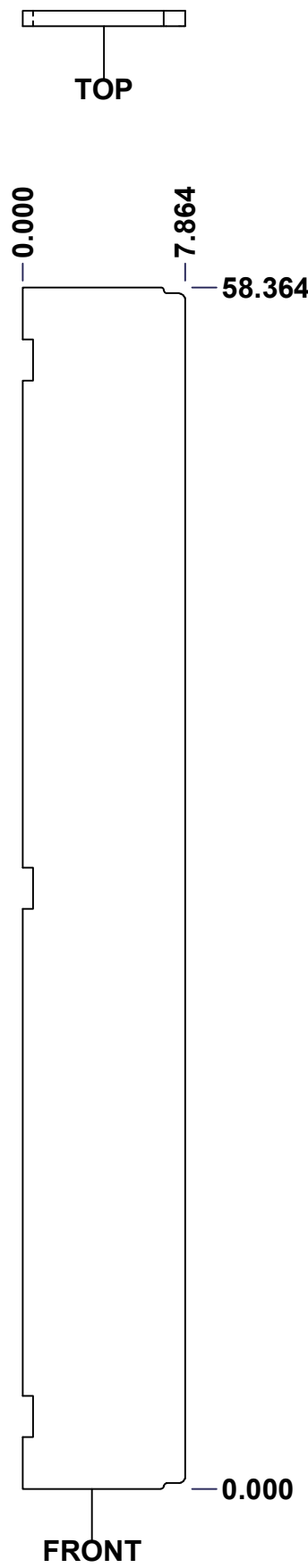

No.	Revisions	Date	By/Par

Isometric View

<p>Tél: (450) 979-4373 Fax: (450) 979-4626 <a href="http://www.exmweb.com">www.exmweb.com</a></p>		Flatness Aplatissement
		Max 3.0mm
		Projection
Customer Client	Date	
Drawn By Dessiné Par	BoxCad: Patrick Deschenes	Date 23-Jan-07
Material Matière	Polyisocyanurate	
Color Couleur	Aluminum	Finish Fini N/A
Description	Detail Rev.	
5412ESSQT 60" x 36" Left Insulation		
Part Number Numéro Pièce	Rev. 0	12 / 16

SEE BILL OF MATERIAL ON LAST PAGE 5412ESSQT6036086THI-LS

This drawing is confidential and must not be reproduced or used without the consent of EXM

Ce dessin est confidentiel et ne doit pas être reproduit ou utilisé sans le consentement de EXM

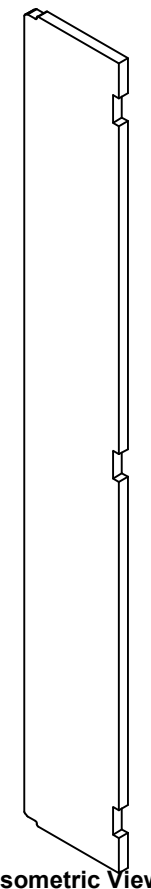
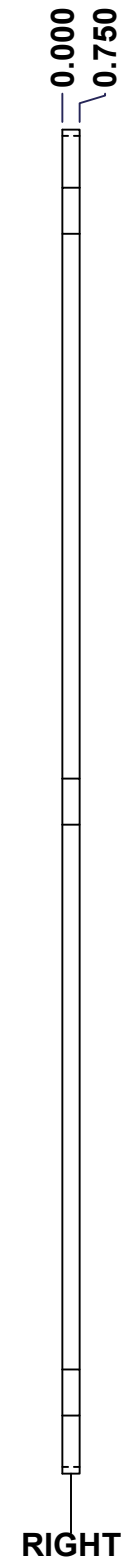
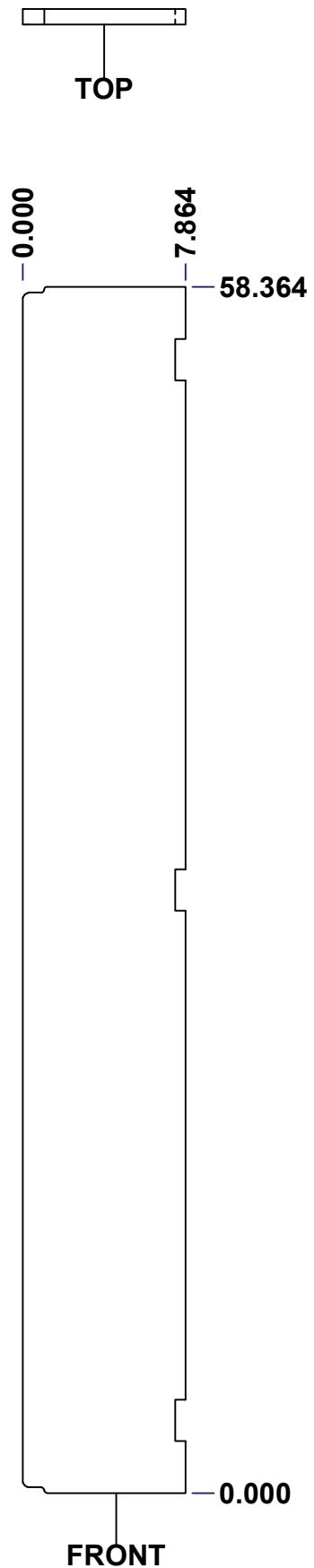

No.	Revisions	Date	By/Par

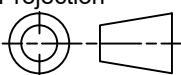
 Tél: (450) 979-4373 Fax: (450) 979-4626 <a href="http://www.exmweb.com">www.exmweb.com</a>		Flatness Aplatissement Max 3.0mm
Projection		
Customer Client	Date	
Drawn By / Dessiné Par: BoxCad: Patrick Deschenes	Date: 23-Jan-07	
Material / Matière: Polyisocyanurate		
Color / Couleur: Aluminum	Finish / Fini: N/A	
Description: 5412ESSQT 60" x 36" Right Insulation		Detail Rev.
Part Number / Numéro Pièce: 5412ESSQT6036086THI-RS		Rev. 13

SEE BILL OF MATERIAL ON LAST PAGE 5412ESSQT6036086THI-RS 0 16

This drawing is confidential and must not be reproduced or used without the consent of EXM

Ce dessin est confidentiel et ne doit pas être reproduit ou utilisé sans le consentement de EXM

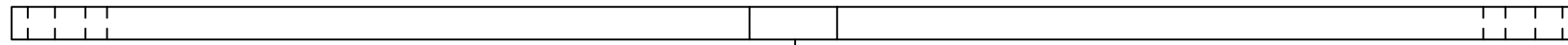

TOP

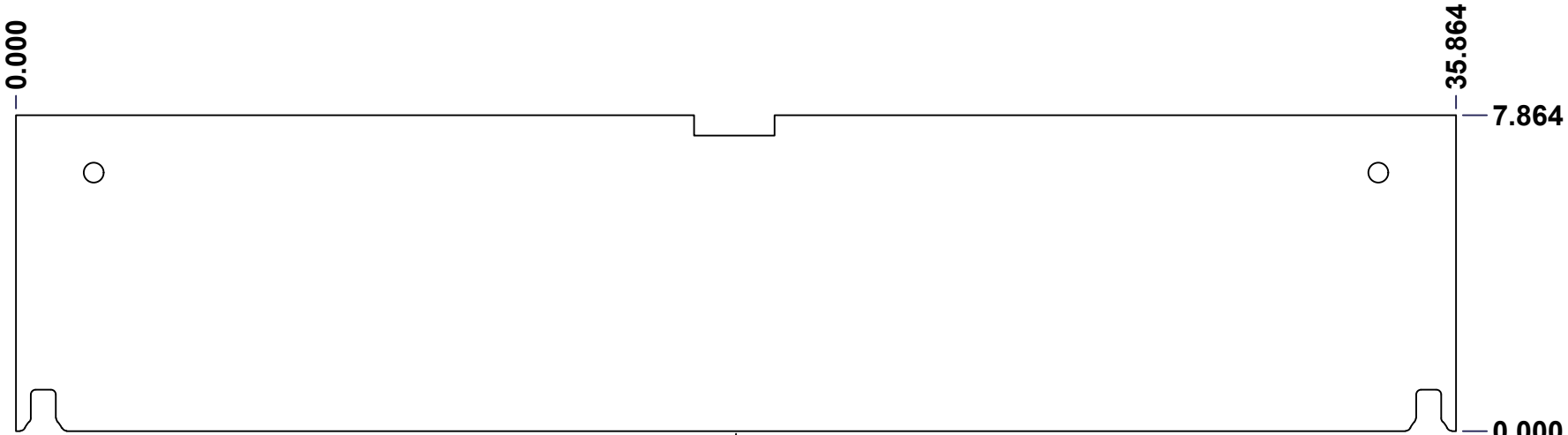

FRONT

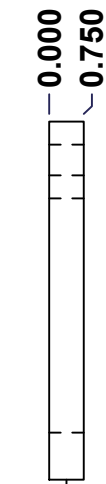

RIGHT

No.	Revisions	Date	By/Par

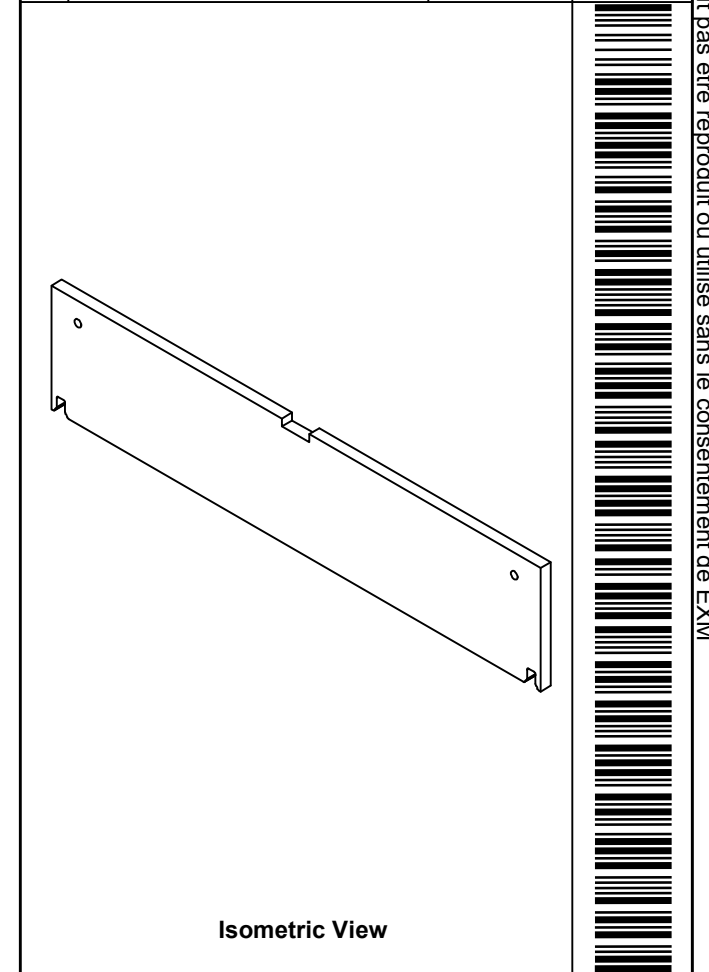

Isometric View

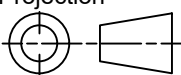
 Tél: (450) 979-4373 Fax: (450) 979-4626 <a href="http://www.exmweb.com">www.exmweb.com</a>		Flatness Aplatissement Max 5.0mm Projection 
Customer Client	Date	
Drawn By Dessiné Par	BoxCad: BoxCad	Date 4/3/2024
Material Matière	Polyisocyanurate	
Color Couleur	Aluminum	Finish Fini Brushed
Description	Detail Rev.	
5412ESSQT 60" x 36"Top Insulation		
Part Number Numéro Pièce	Rev. 0	14 / 16

SEE BILL OF MATERIAL ON LAST PAGE **5412ESSQT6036086THI-TP**

This drawing is confidential and must not be reproduced or used without the consent of EXM

Ce dessin est confidentiel et ne doit pas être reproduit ou utilisé sans le consentement de EXM

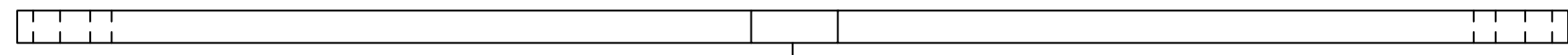

TOP

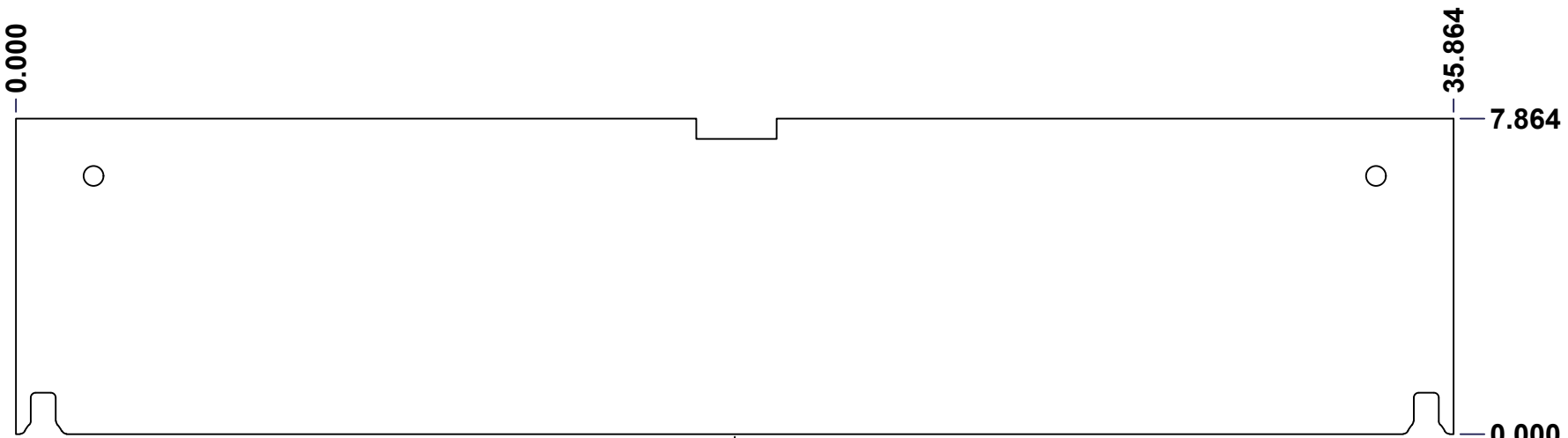

FRONT

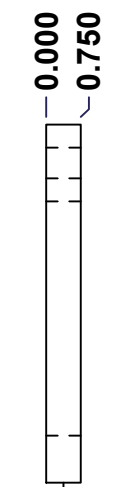

RIGHT

No.	Revisions	Date	By/Par

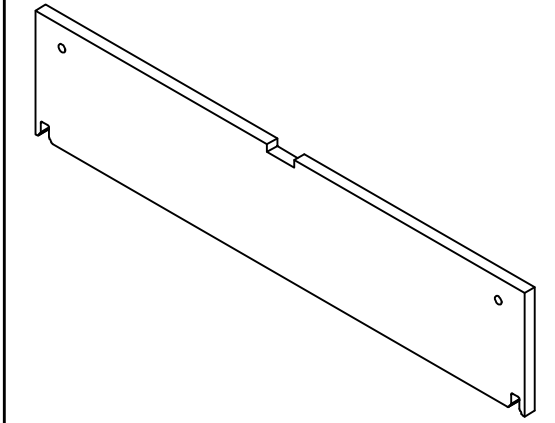
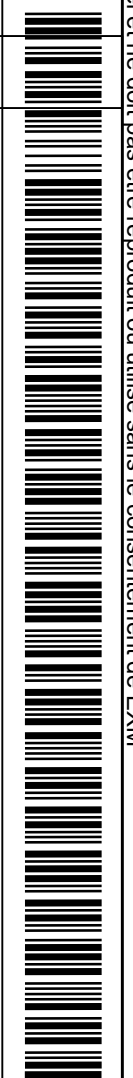

Isometric View

 Tél: (450) 979-4373  
 Fax: (450) 979-4626  
[www.exmweb.com](http://www.exmweb.com)

Flatness / Aplatissement: Max 5.0mm  
 Projection: 

Customer Client	Date
Drawn By / Dessiné Par: BoxCad: BoxCad	Date: 4/3/2024
Material / Matière: Polyisocyanurate	
Color / Couleur: Aluminum	Finish / Fini: Brushed
Description: 5412ESSQT 60" x 36"Bottom Insulation	Detail Rev.
Part Number / Numéro Pièce: 5412ESSQT6036086THI-BT	Rev. 15
SEE BILL OF MATERIAL ON LAST PAGE	0

SEE BILL OF MATERIAL ON LAST PAGE 5412ESSQT6036086THI-BT 0 16

This drawing is confidential and must not be reproduced or used without the consent of EXM

Ce dessin est confidentiel et ne doit pas être reproduit ou utilisé sans le consentement de EXM

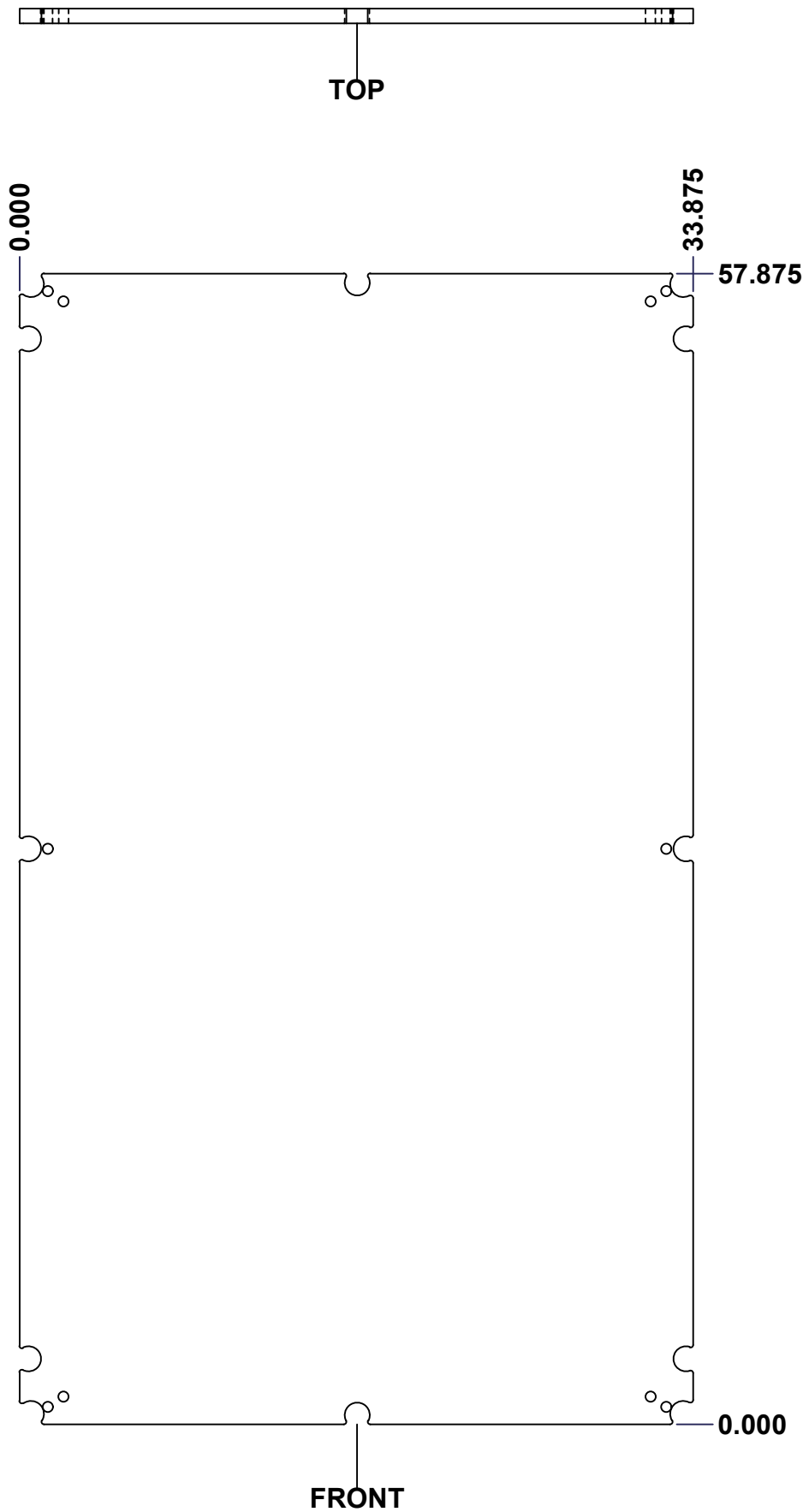

No.	Revisions	Date	By/Par

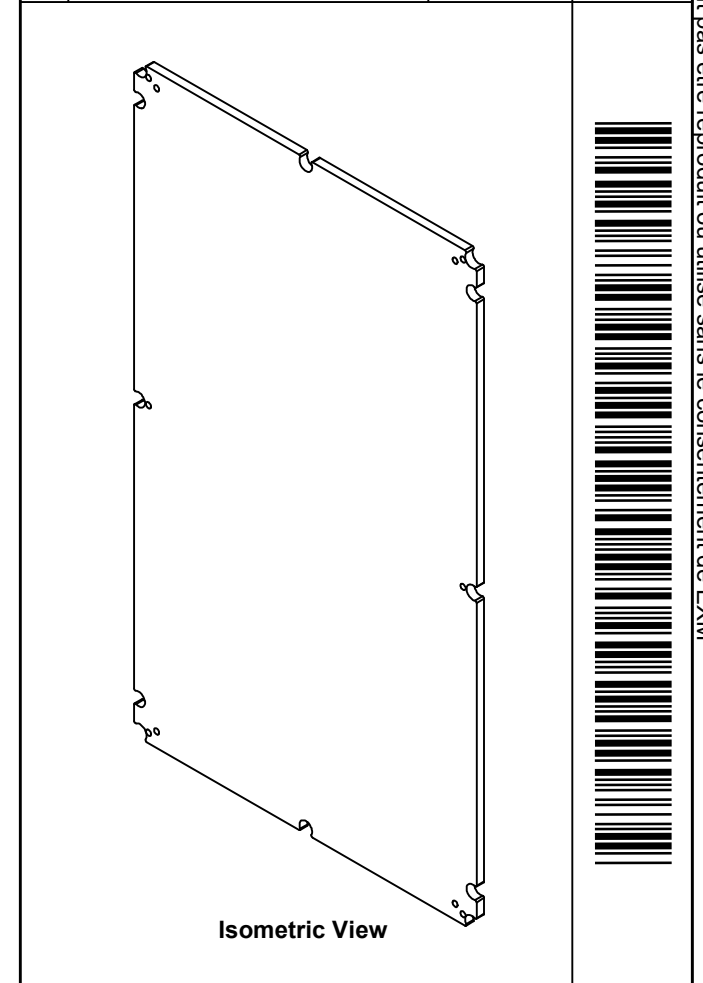

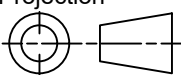
 Tél: (450) 979-4373 Fax: (450) 979-4626 <a href="http://www.exmweb.com">www.exmweb.com</a>		Flatness Aplatissement Max 3.0mm Projection 
Customer Client	Date	
Drawn By Dessiné Par	BoxCad: Patrick Deschenes	Date 23-Jan-07
Material Matière	Polyisocyanurate	
Color Couleur	Aluminum	Finish Fini N/A
Description	Detail Rev.	
5412ESSQT 60" x 36" Cover Insulation		
Part Number Numéro Pièce	Rev. 0	16 / 16
<b>5412ESSQT6036086THI-C</b>		

SEE BILL OF MATERIAL ON LAST PAGE

This drawing is confidential and must not be reproduced or used without the consent of EXM

Ce dessin est confidentiel et ne doit pas être reproduit ou utilisé sans le consentement de EXM

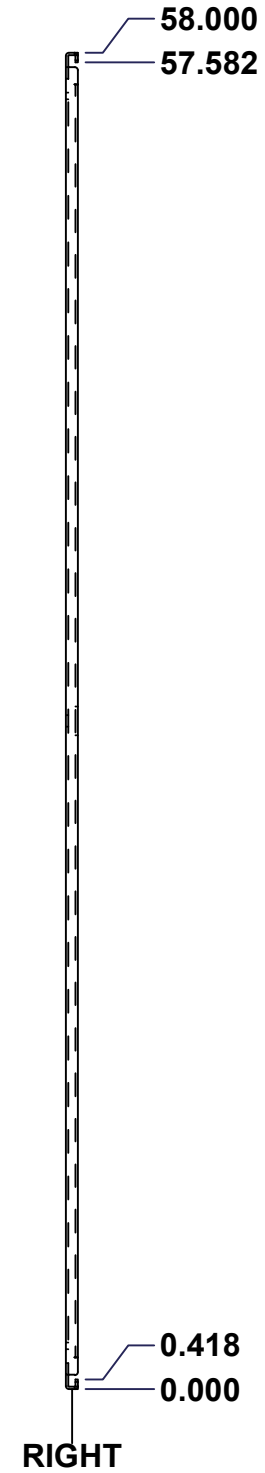
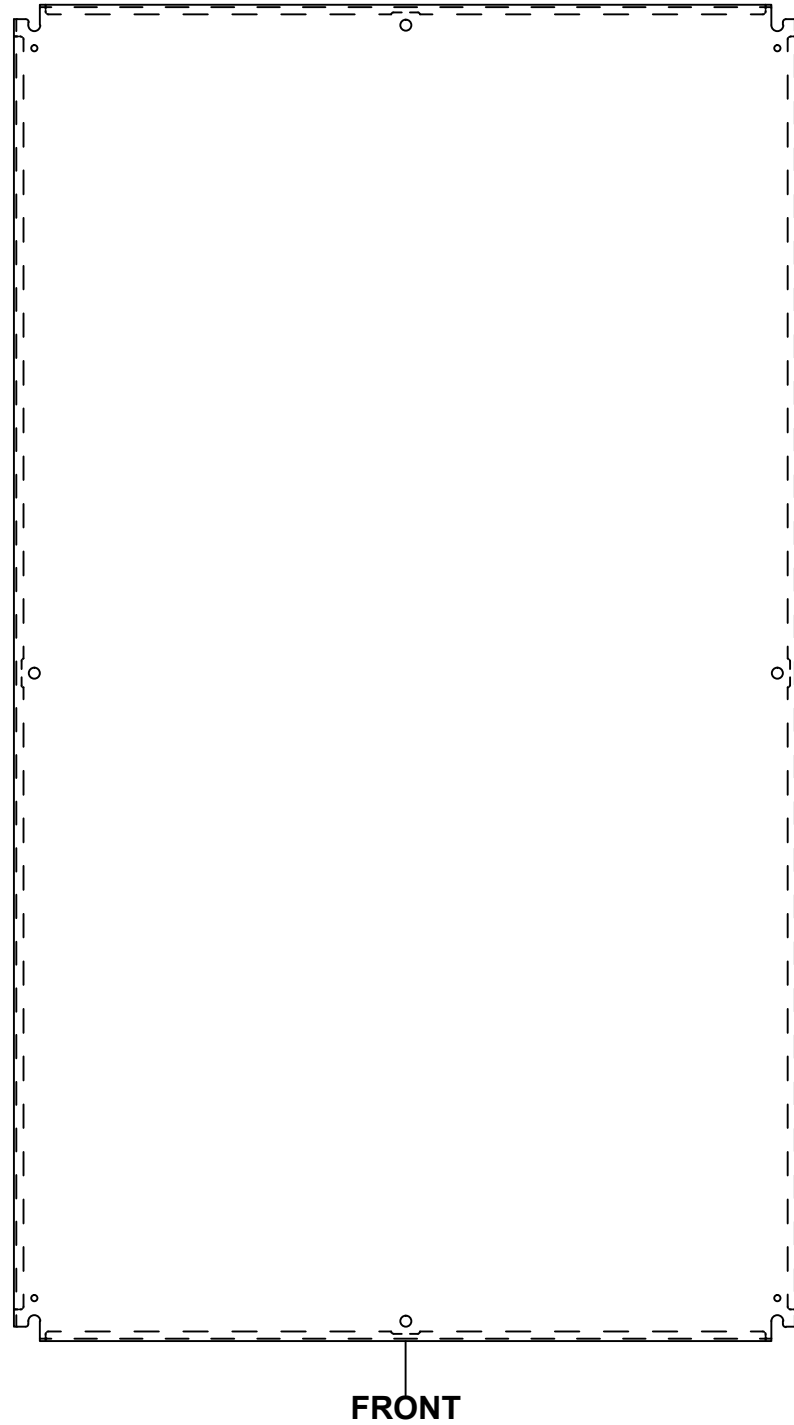
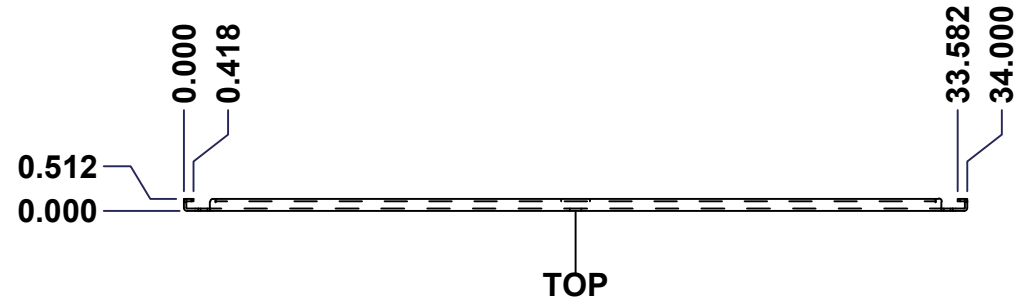

No.	Revisions	Date	By/Par

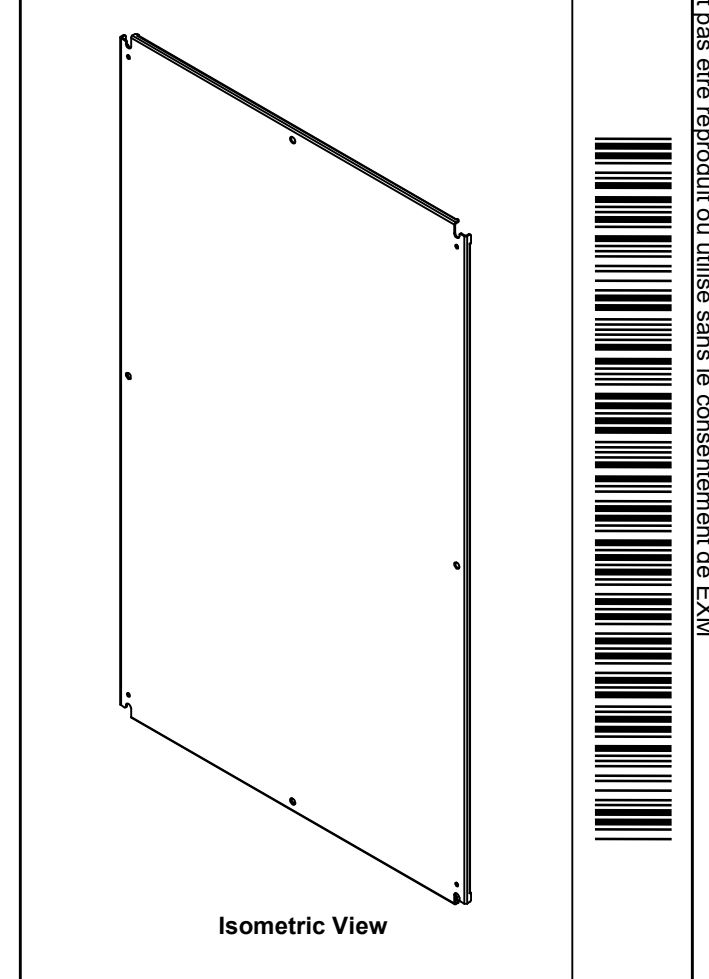

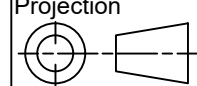
 Tél: (450) 979-4373 Fax: (450) 979-4626 www.exmweb.com		Flatness Aplatissement Max 3.0mm Projection 
Customer Client	Date	
Drawn By Dessiné Par: BoxCad	Date: 23-Jan-07	
Material Matière	See Part List	
Color Couleur	See Part List	Finish Fini: See Part List
Description: 881 SP - Inner Panel		Detail Rev.
Part Number Numéro Pièce: <b>881 SP6036G</b>	Rev. <b>0</b>	1 2

Qty	Part Number	Rev	Description	Material	Color	Finish
1	881 SP6036G-P	0	881 SP - Inner Panel Part	12 Ga Galvanized	Unpainted	Galvanized

Parts List

This drawing is confidential and must not be reproduced or used without the consent of EXM

Ce dessin est confidentiel et ne doit pas être reproduit ou utilisé sans le consentement de EXM

Table 1			FRONT VIEW
CUT-OUT	XDIM	YDIM	DESCRIPTION
1	17.000	0.875	MTG STUD HOLE (RND Ø0.500)
2	0.875	29.000	MTG STUD HOLE (RND Ø0.500)
3	33.125	29.000	MTG STUD HOLE (RND Ø0.500)
4	17.000	57.125	MTG STUD HOLE (RND Ø0.500)
5	0.875	1.875	GROUND HOLE (RND Ø0.290)
6	33.125	1.875	GROUND HOLE (RND Ø0.290)
7	0.875	56.125	GROUND HOLE (RND Ø0.290)
8	33.125	56.125	GROUND HOLE (RND Ø0.290)



All knockouts are actual size / Les disques défonçables sont grandeur réel

No.	Revisions	Date	By/Par

Isometric View

		Tél: (450) 979-4373 Fax: (450) 979-4626 www.exmweb.com		Flatness Aplatissement Max 3.0mm	
Customer Client		Date		Projection 	
Drawn By Dessiné Par		BoxCad		Date 23-Jan-07	
Material Matière		See Part List			
Color Couleur		See Part List		Finish Fini	
Description 881 SP - Inner Panel				Detail Rev.	
Part Number Numéro Pièce <b>881 SP6036G</b>				Rev. 2 <b>0</b>	