

This drawing is confidential and must not be reproduced or used without the consent of EXM

Ce dessin est confidentiel et ne doit pas être reproduit ou utilisé sans le consentement de EXM

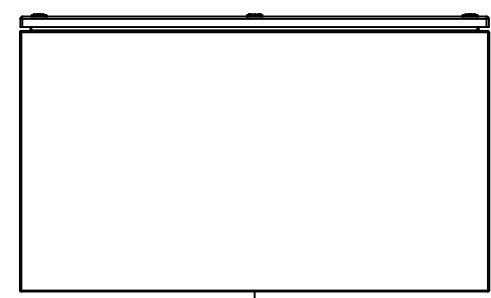

TOP

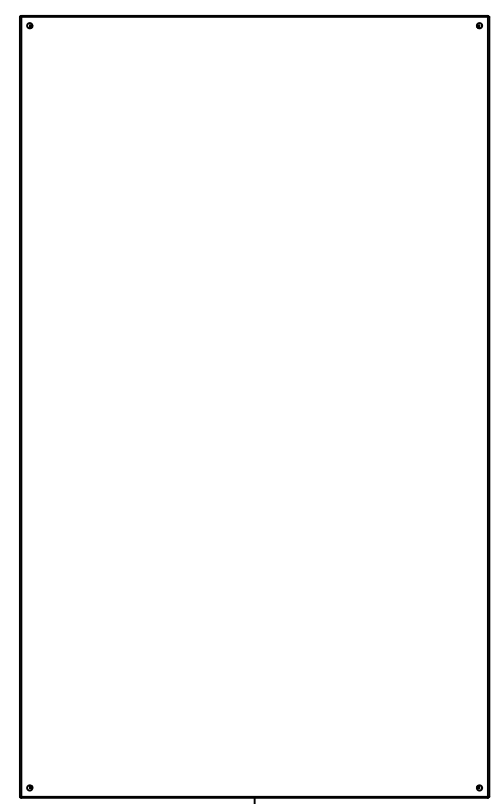

BACK

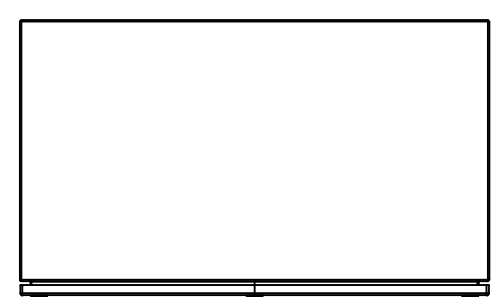

BOTTOM

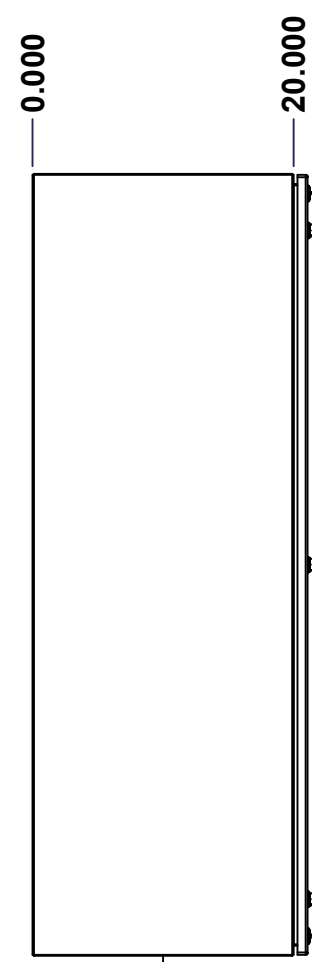

LEFT

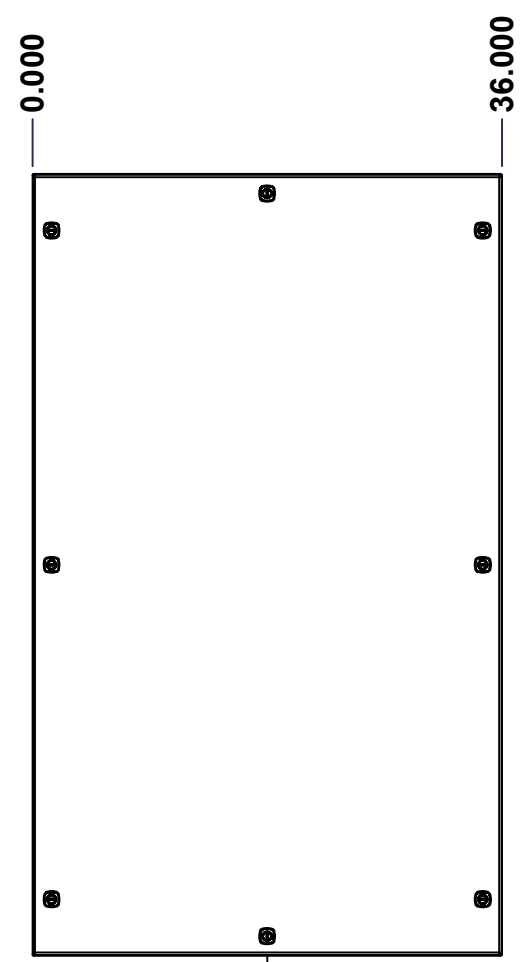

FRONT

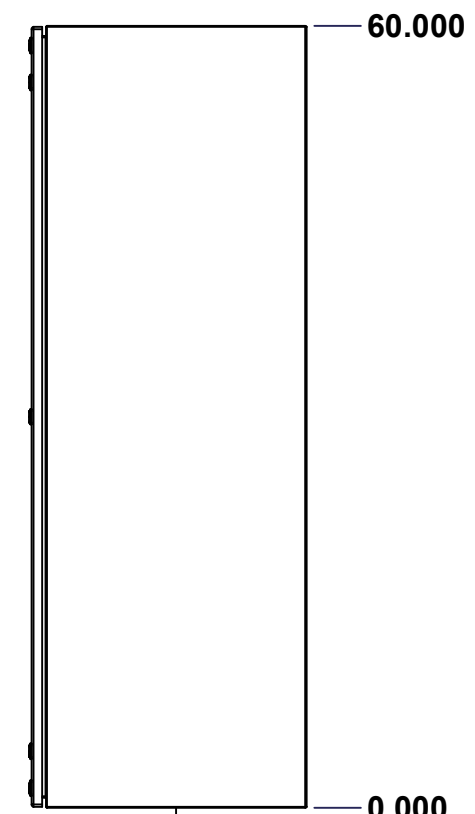

RIGHT

No.	Revisions	Date	By/Par

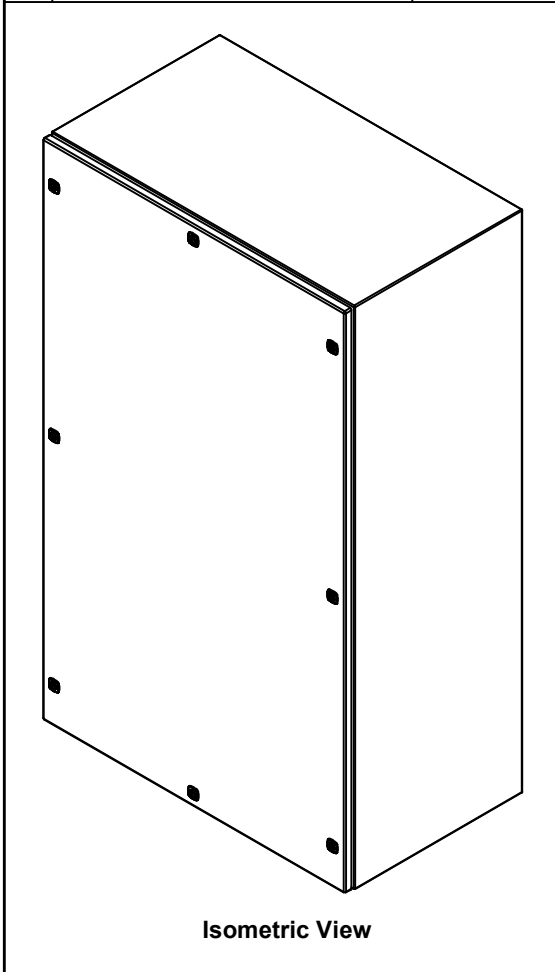

Isometric View

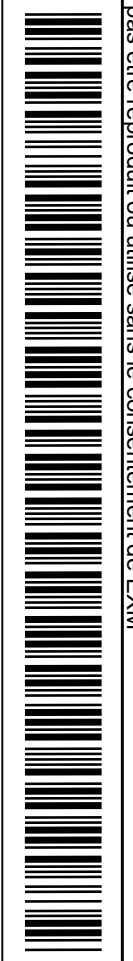

**GRAIN DIRECTION:  
TOP/BOTTOM: HORIZONTAL  
LEFT/RIGHT/BACK/FRONT: VERTICAL**

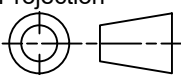
 Tél: (450) 979-4373 Fax: (450) 979-4626 <a href="http://www.exmweb.com">www.exmweb.com</a>		Flatness Aplatissement Max 3.0mm Projection 
Customer Client	Date	
Drawn By Dessiné Par	BoxCad: BoxCad	Date 03-Feb-26
Material Matière	14 Ga Stainless Steel 316 (1.7mm)	
Color Couleur	Unpainted	Finish Fini Brushed
Description	Detail Rev.	
5412ESSQT 60" x 36" x 20" Assembly		
Part Number Numéro Pièce	Rev.	1
5412ESSQT6036206	0	9

SEE BILL OF MATERIAL ON LAST PAGE

This drawing is confidential and must not be reproduced or used without the consent of EXM

Ce dessin est confidentiel et ne doit pas être reproduit ou utilisé sans le consentement de EXM

NOTE	
ITEM	DESCRIPTION
1	NEMA 4X Enclosure (IP66)
2	C/W Standard ground studs on box and cover
3	C/W Standard door stiffener
4	C/W Standard inner panel (Included)
5	C/W Standard inner panel mounting studs

No.	Revisions	Date	By/Par

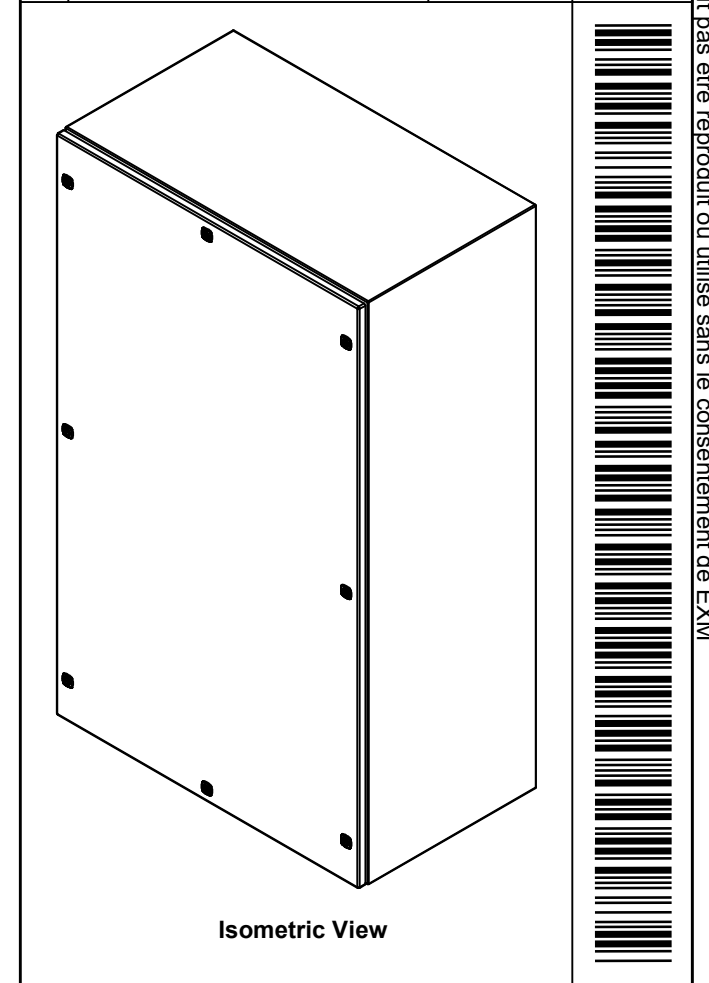

PACKING		
ITEM	QTY	DESCRIPTION
Cardboard sleeve	2	Top and Bottom
Cardboard strip	2	Between back of enclosure and inner panel
Plastic bag	1	To protect cover surface and inside gasket
Cardboard corner	4	To reinforced for the plastic strap tightening
Plastic strap - Black	2	To Squeeze the 2 cardboard sleeve together
Packaging label	3	White label with PN
Plastic strap- Green	2	To secure the enclosure to the wood pallet
Wood Pallet	1	2" deeper and 3" larger than enclosure size

1	STK-K-01800	5	5412 ES Accessory Kit
1	881 SP6036G	0	881 SP - Inner Panel
4	STK-K-01320	0	5412 ES Inner Panel Accessory Kit
1	5412ESSQT6036206C	0	5412ESSQT 60" x 36" Cover
1	5412ESSQT6036206B	0	5412ESSQT 60" x 36" x 20" Body
Qty	Part Number	Rev	Description
Parts List			

	Flatness Aplatissement Max 3.0mm
	Projection 
Customer Client	Date
Drawn By Dessiné Par	BoxCad: BoxCad Date 03-Feb-26
Material Matière	14 Ga Stainless Steel 316 (1.7mm)
Color Couleur	Unpainted Finish Brushed
Description 5412ESSQT 60" x 36" x 20" Assembly	Detail Rev.
Part Number Numéro Pièce <b>5412ESSQT6036206</b>	Rev. 0 2 9

This drawing is confidential and must not be reproduced or used without the consent of EXM

Ce dessin est confidentiel et ne doit pas être reproduit ou utilisé sans le consentement de EXM

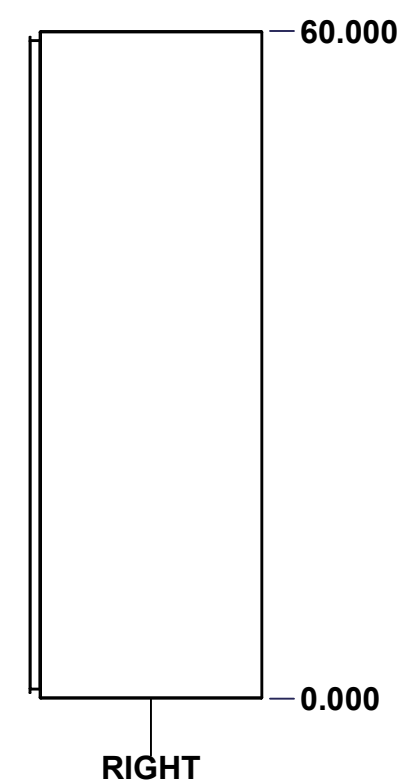
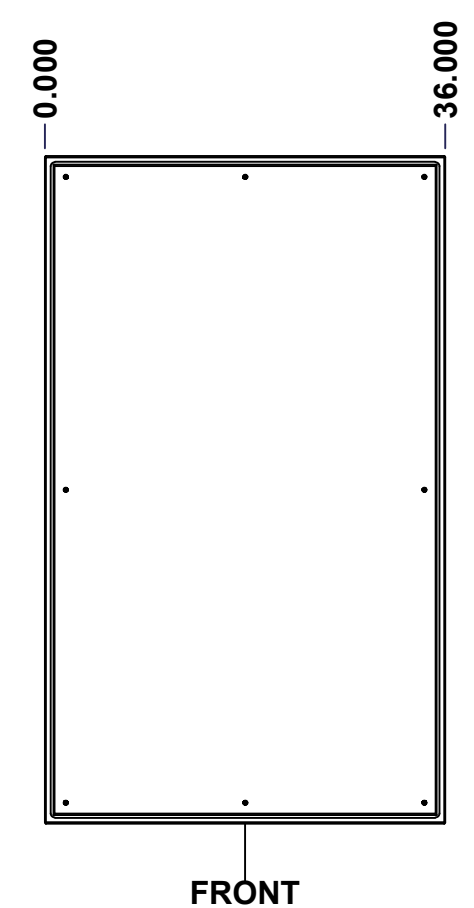
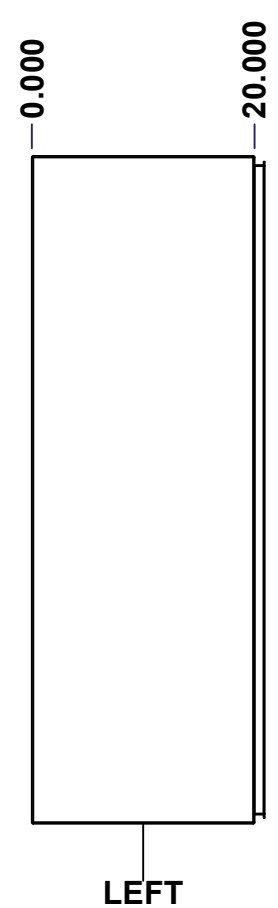
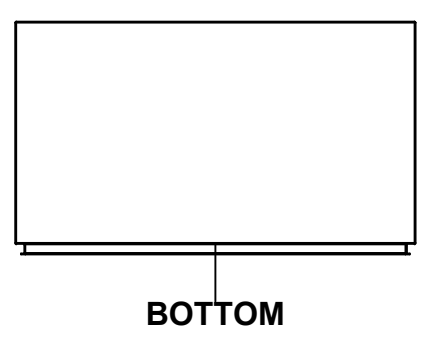
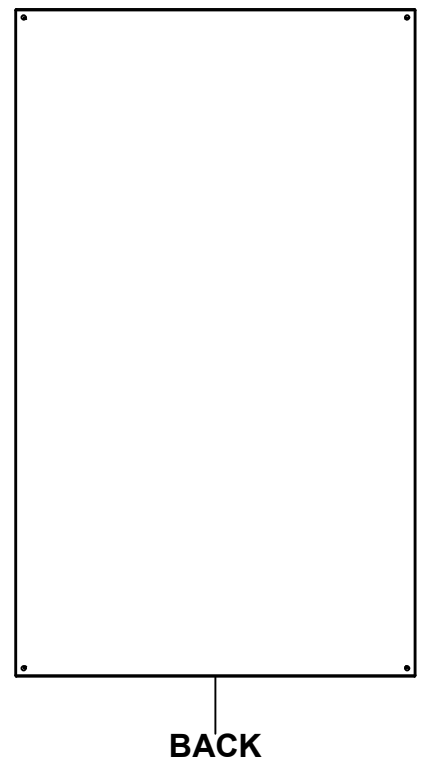
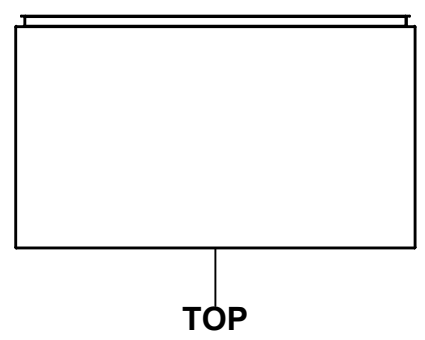

No.	Revisions	Date	By/Par

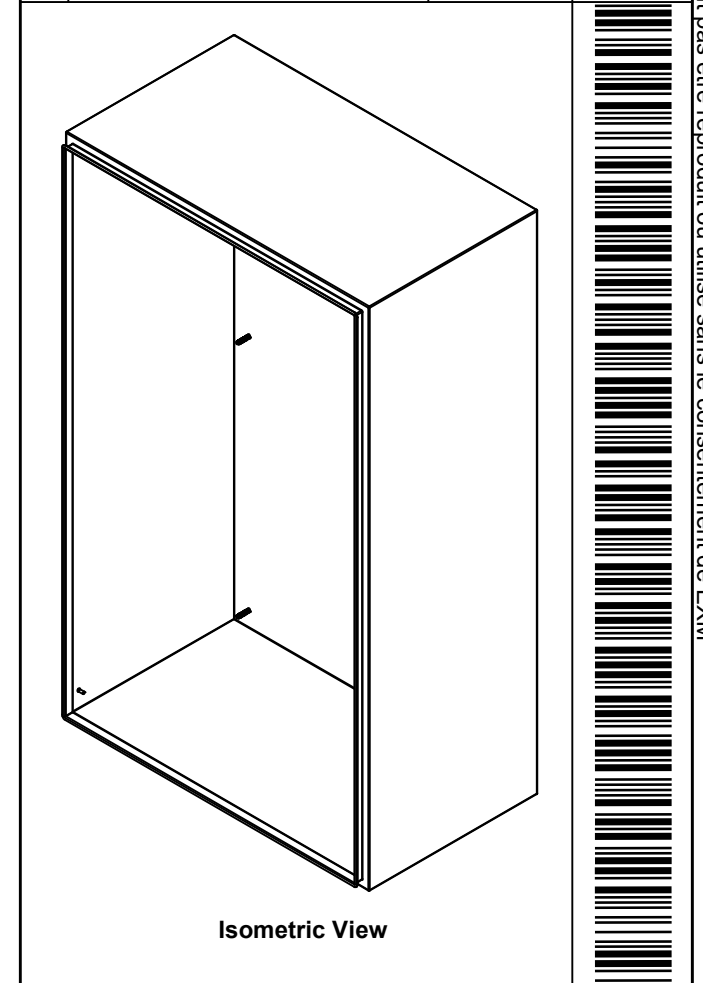

Tél: (450) 979-4373 Fax: (450) 979-4626 <a href="http://www.exmweb.com">www.exmweb.com</a>		Flatness Aplatissement
		Max 3.0mm
Projection		Date
Customer Client	BoxCad: BoxCad	Date
Drawn By Dessiné Par	BoxCad: BoxCad	03-Feb-26
Material Matière	14 Ga Stainless Steel 316 (1.7mm)	
Color Couleur	Unpainted	Finish Fini: Brushed
Description	Detail Rev.	
5412ESSQT 60" x 36" x 20" Body		
Part Number Numéro Pièce	Rev.	3
<b>5412ESSQT6036206B</b>	<b>0</b>	9

**SEE BILL OF MATERIAL ON LAST PAGE**

This drawing is confidential and must not be reproduced or used without the consent of EXM

Ce dessin est confidentiel et ne doit pas être reproduit ou utilisé sans le consentement de EXM

<b>STANDARD FEATURES ARE NOT LISTED IN THIS HOLE TABLE</b>			
<b>HOLE TABLE - LEFT VIEW (CUSTOM FEATURE ONLY)</b>			
CUT-OUT	XDIM	YDIM	DESCRIPTION
1	18.500	2.000	GND STUD M6 x 16mm (Inside)

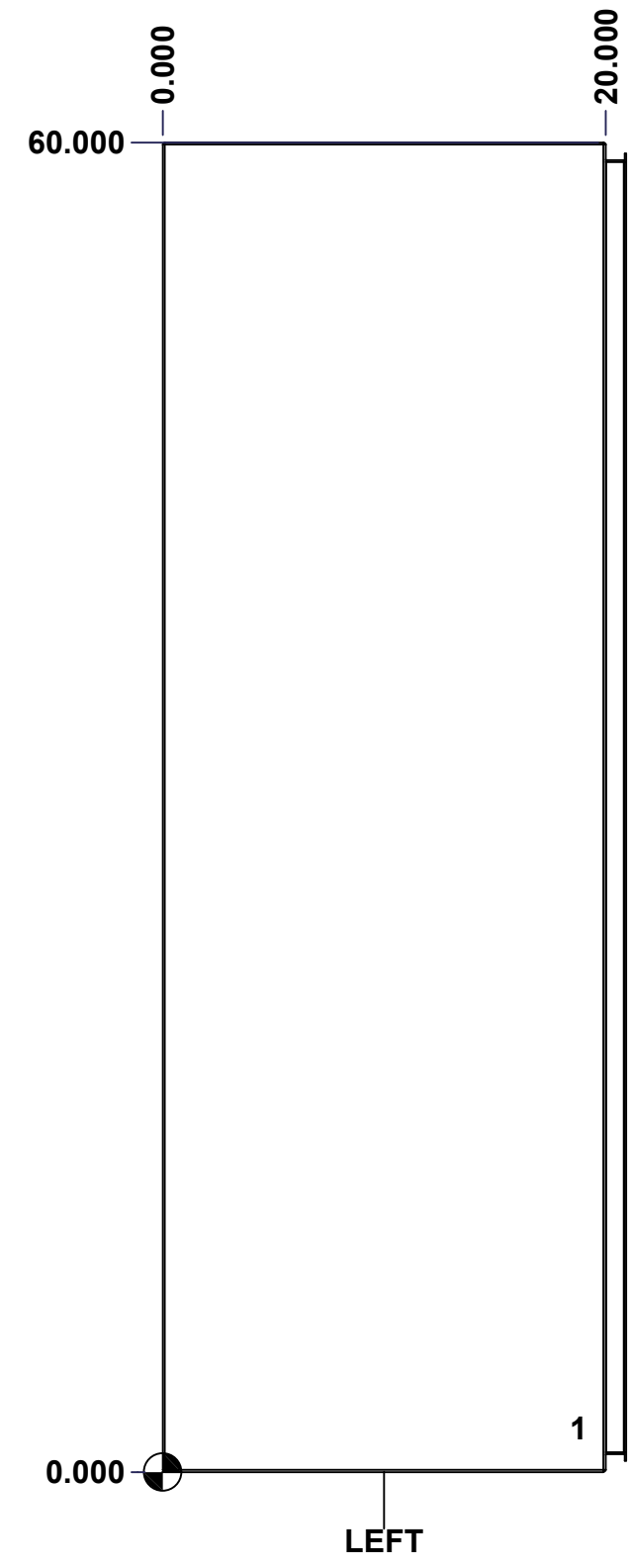

	Description	Status	
	5412ESSQT 60" x 36" x 20" Body	(NULL)	
	Part Number Numéro Pièce	Rev.	
	<b>5412ESSQT6036206B</b>	<b>0</b>	4 9

This drawing is confidential and must not be reproduced or used without the consent of EXM

Ce dessin est confidentiel et ne doit pas être reproduit ou utilisé sans le consentement de EXM

**STANDARD FEATURES ARE NOT LISTED IN THIS HOLE TABLE**

**HOLE TABLE - BACK VIEW (CUSTOM FEATURE ONLY)**

CUT-OUT	XDIM	YDIM	DESCRIPTION
1	1.875	1.875	IP STUD M8 x 35mm (Inside)
2	1.875	58.125	IP STUD M8 x 35mm (Inside)
3	34.125	58.125	IP STUD M8 x 35mm (Inside)
4	34.125	1.875	IP STUD M8 x 35mm (Inside)
5	18.000	1.875	IP STUD M8 x 35mm (Inside)
6	18.000	58.125	IP STUD M8 x 35mm (Inside)
7	1.875	30.000	IP STUD M8 x 35mm (Inside)
8	34.125	30.000	IP STUD M8 x 35mm (Inside)
-----			
9	0.750	0.750	RND Ø0.390
10	0.750	59.250	RND Ø0.390
11	35.250	0.750	RND Ø0.390
12	35.250	59.250	RND Ø0.390

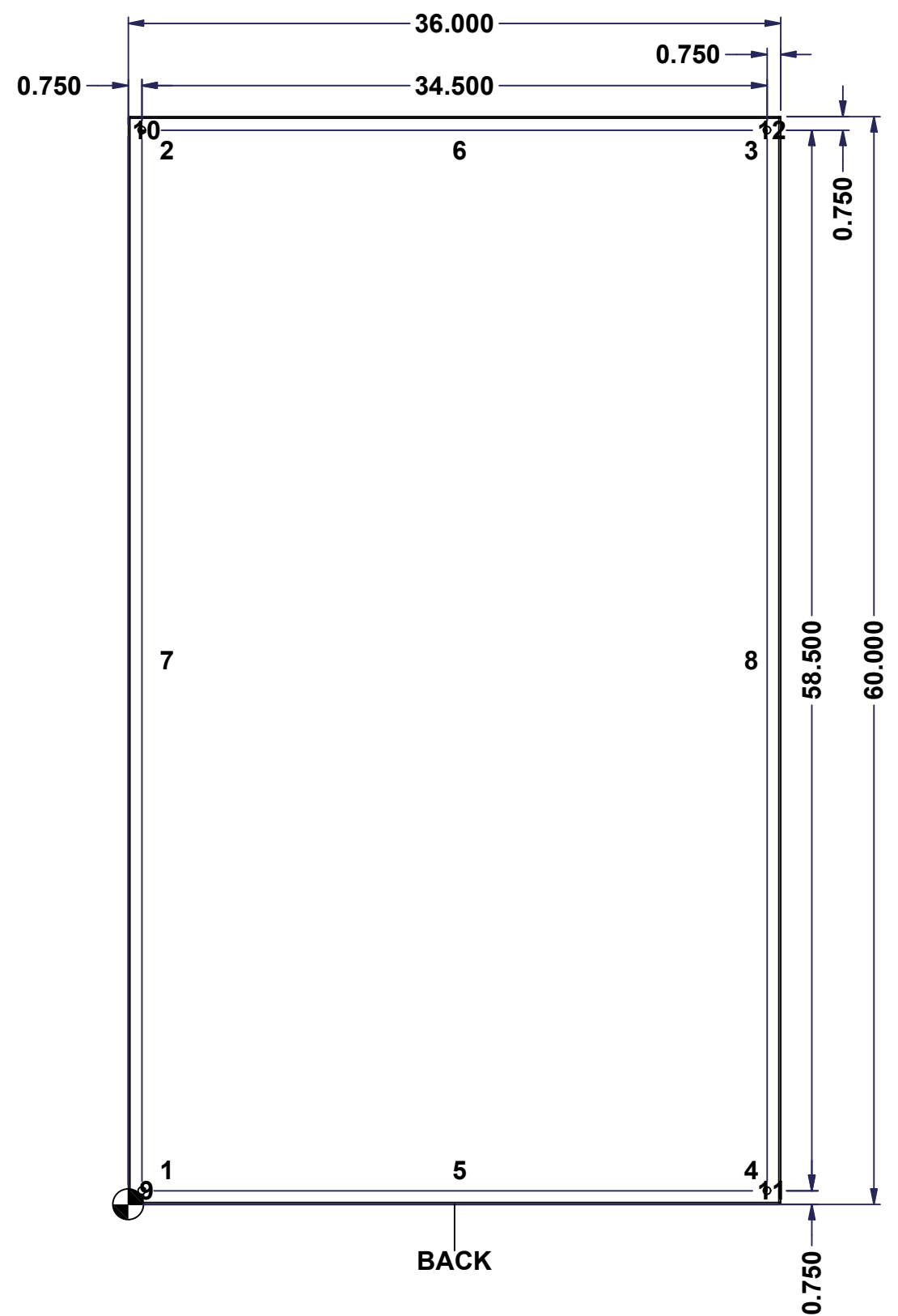

BACK

	Description	Status
	5412ESSQT 60" x 36" x 20" Body	(NULL)
	Part Number	Rev.
	5412ESSQT6036206B	5
		9

This drawing is confidential and must not be reproduced or used without the consent of EXM

Ce dessin est confidentiel et ne doit pas être reproduit ou utilisé sans le consentement de EXM

No.	Revisions	Date	By/Par

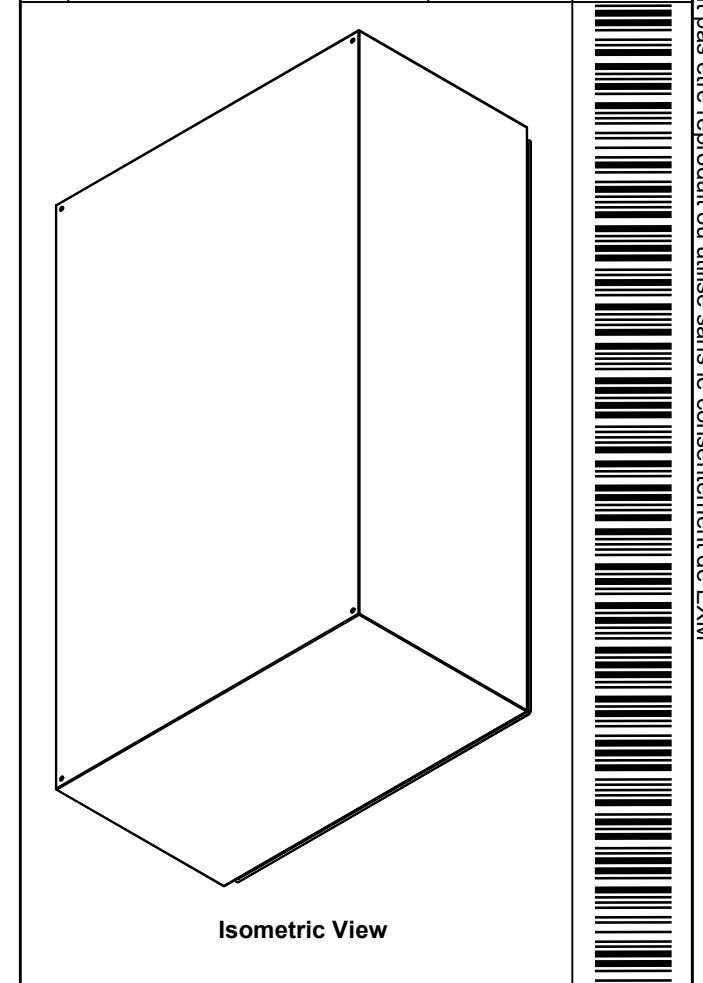

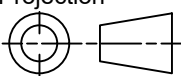
 Tél: (450) 979-4373 Fax: (450) 979-4626 <a href="http://www.exmweb.com">www.exmweb.com</a>		Flatness Aplatissement Max 3.0mm
Customer Client		Projection 
Drawn By / Dessiné Par: BoxCad: BoxCad		Date: 03-Feb-26
Material / Matière: 14 Ga Stainless Steel 316 (1.7mm)		
Color / Couleur: Unpainted	Finish / Fini: Brushed	
Description: 5412ESSQT 60" x 36" x 20" Body		Detail Rev.
Part Number / Numéro Pièce: <b>5412ESSQT6036206B</b>		Rev. 6 0 9

Qty	Part Number	Rev	Description
1	STK-Q-16085	0	Ground Stud M6 x 16mm Stainless Steel
8	STK-Q-16020	1	Stud M8 x 35mm Stainless Steel
1	5412ESSQT6036206B-P	0	5412ESSQT 60" x 36" x 20" Body Part
Parts List			

This drawing is confidential and must not be reproduced or used without the consent of EXM

Ce dessin est confidentiel et ne doit pas être reproduit ou utilisé sans le consentement de EXM

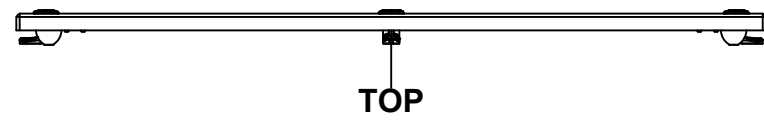

TOP

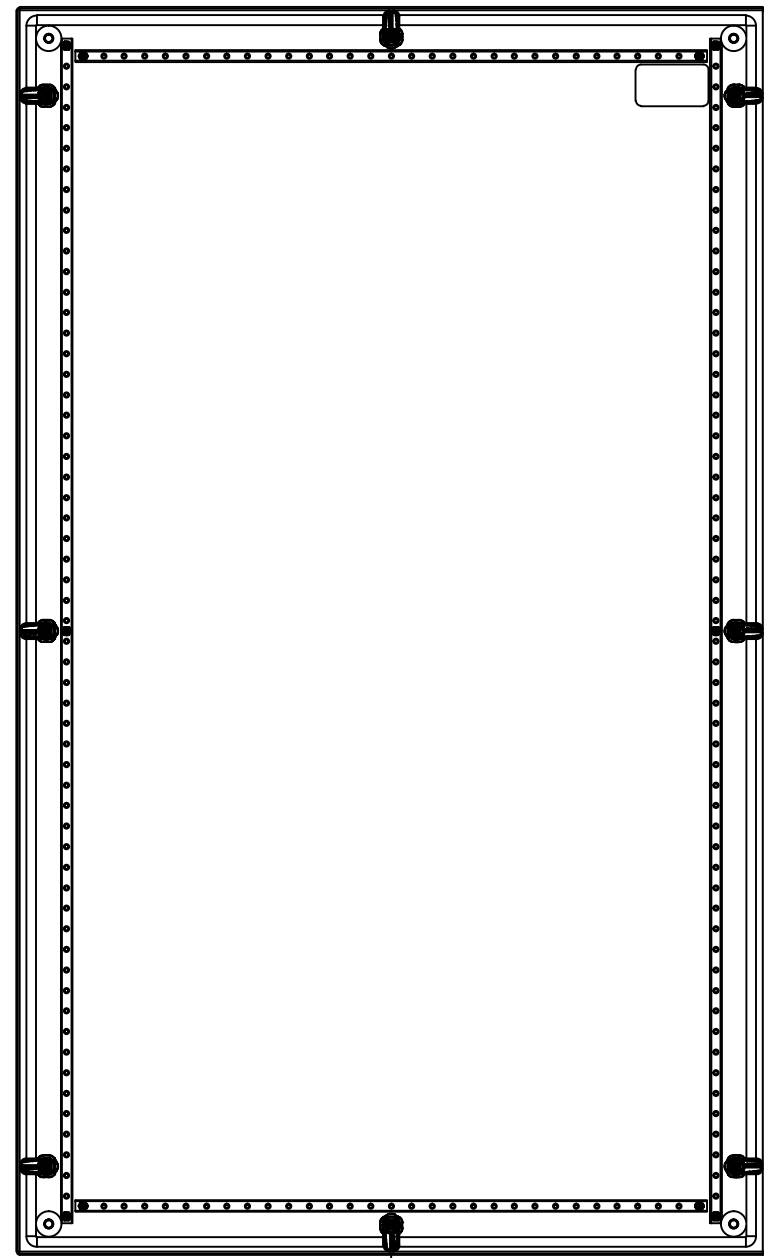

BACK



BOTTOM

0.000  
0.800

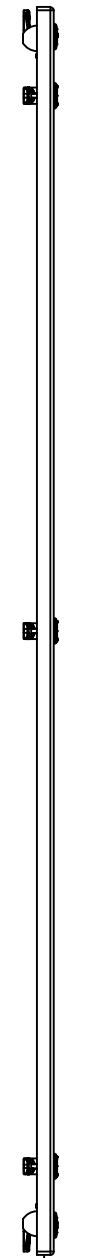

LEFT

0.000  
35.918

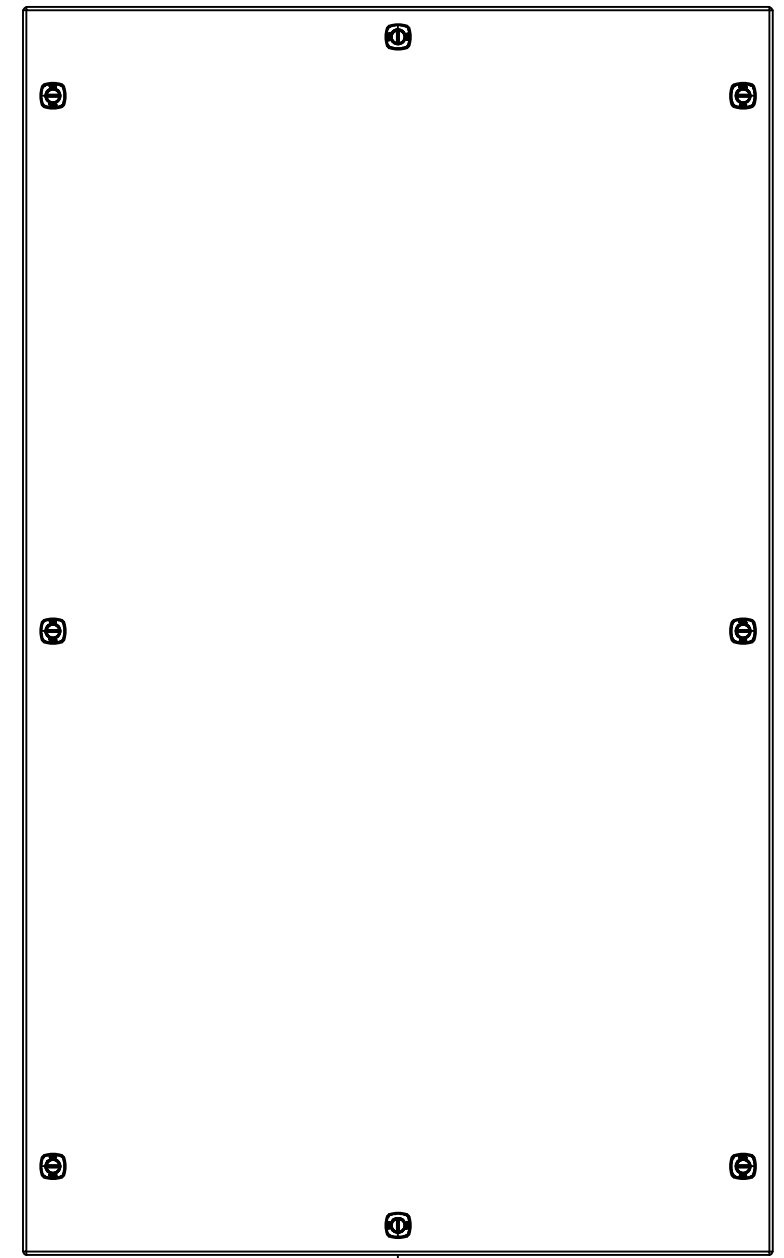

FRONT

59.803

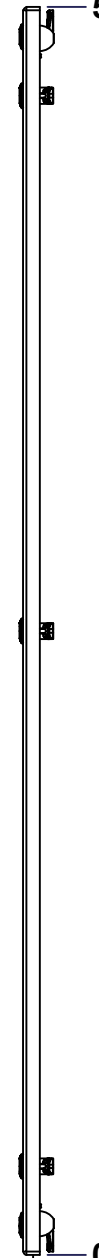

RIGHT

0.000

No.	Revisions	Date	By/Par

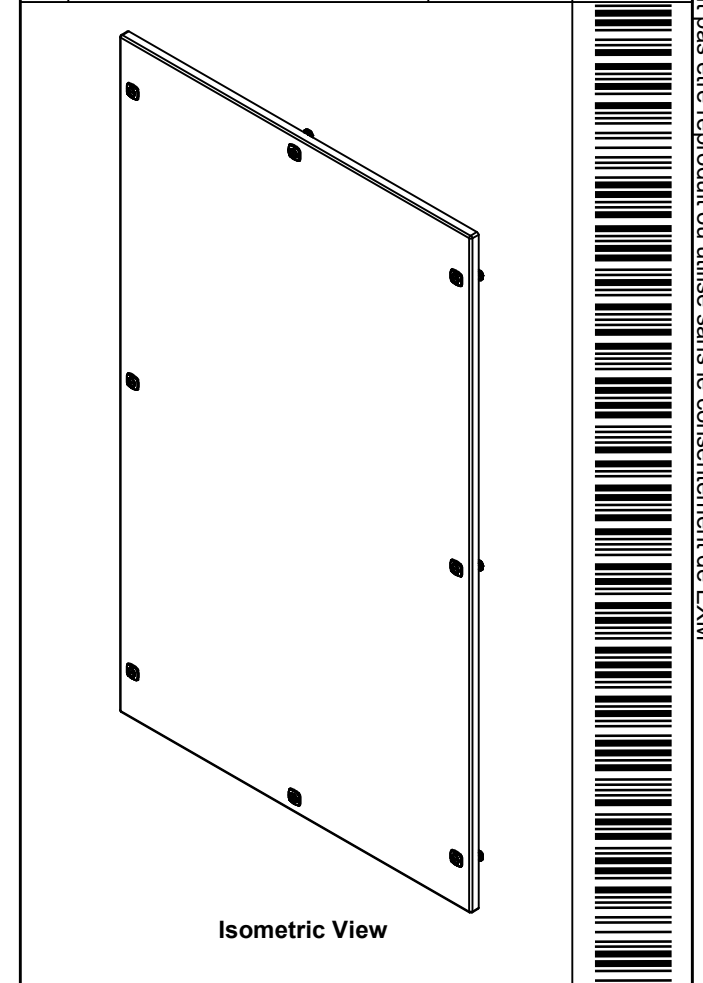

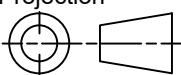
 Tél: (450) 979-4373 Fax: (450) 979-4626 <a href="http://www.exmweb.com">www.exmweb.com</a>		Flatness Aplatissement	
		Max 3.0mm	
Customer Client		Date	
Drawn By Dessiné Par		Date	
Material Matière		Projection	
14 Ga Stainless Steel 316 (1.7mm)			
Color Couleur		Detail Rev.	
Unpainted		7	
Finish Fini		9	
Brushed		0	
Description		Part Number Numéro Pièce	
5412ESSQT 60" x 36" Cover		5412ESSQT6036206C	
SEE BILL OF MATERIAL ON LAST PAGE		Rev. 0	

This drawing is confidential and must not be reproduced or used without the consent of EXM

Ce dessin est confidentiel et ne doit pas être reproduit ou utilisé sans le consentement de EXM

**STANDARD FEATURES ARE NOT LISTED IN THIS HOLE TABLE**

**HOLE TABLE - FRONT VIEW (CUSTOM FEATURE ONLY)**

CUT-OUT	XDIM	YDIM	DESCRIPTION
1	2.401	1.850	STUD M6 x 18mm (Inside)
2	2.401	57.953	STUD M6 x 18mm (Inside)
3	33.517	57.953	STUD M6 x 18mm (Inside)
4	33.517	1.850	STUD M6 x 18mm (Inside)
5	2.401	29.902	STUD M6 x 18mm (Inside)
6	33.517	29.902	STUD M6 x 18mm (Inside)
7	3.195	2.350	STUD M6 x 18mm (Inside)
8	3.195	59.803	STUD M6 x 18mm (Inside)
9	32.723	59.803	STUD M6 x 18mm (Inside)
10	32.723	2.350	STUD M6 x 18mm (Inside)
11	1.550	1.500	STUD M6 x 18mm (Inside)
12	34.368	1.500	STUD M6 x 18mm (Inside)
13	1.550	58.303	STUD M6 x 18mm (Inside)
14	34.368	58.303	STUD M6 x 18mm (Inside)
-----			
15	1.424	4.250	LOCK 880 SCQ4-SLSS6 @ 180.0°
16	1.424	29.902	LOCK 880 SCQ4-SLSS6 @ 180.0°
17	1.424	55.553	LOCK 880 SCQ4-SLSS6 @ 180.0°
18	4.500	56.053	LABEL_EXM (Inside)
19	17.959	1.424	LOCK 880 SCQ4-SLSS6 @ 270.0°
20	17.959	58.379	LOCK 880 SCQ4-SLSS6 @ 90.0°
21	34.494	4.250	LOCK 880 SCQ4-SLSS6 @ 0.0°
22	34.494	29.902	LOCK 880 SCQ4-SLSS6 @ 0.0°
23	34.494	55.553	LOCK 880 SCQ4-SLSS6 @ 0.0°

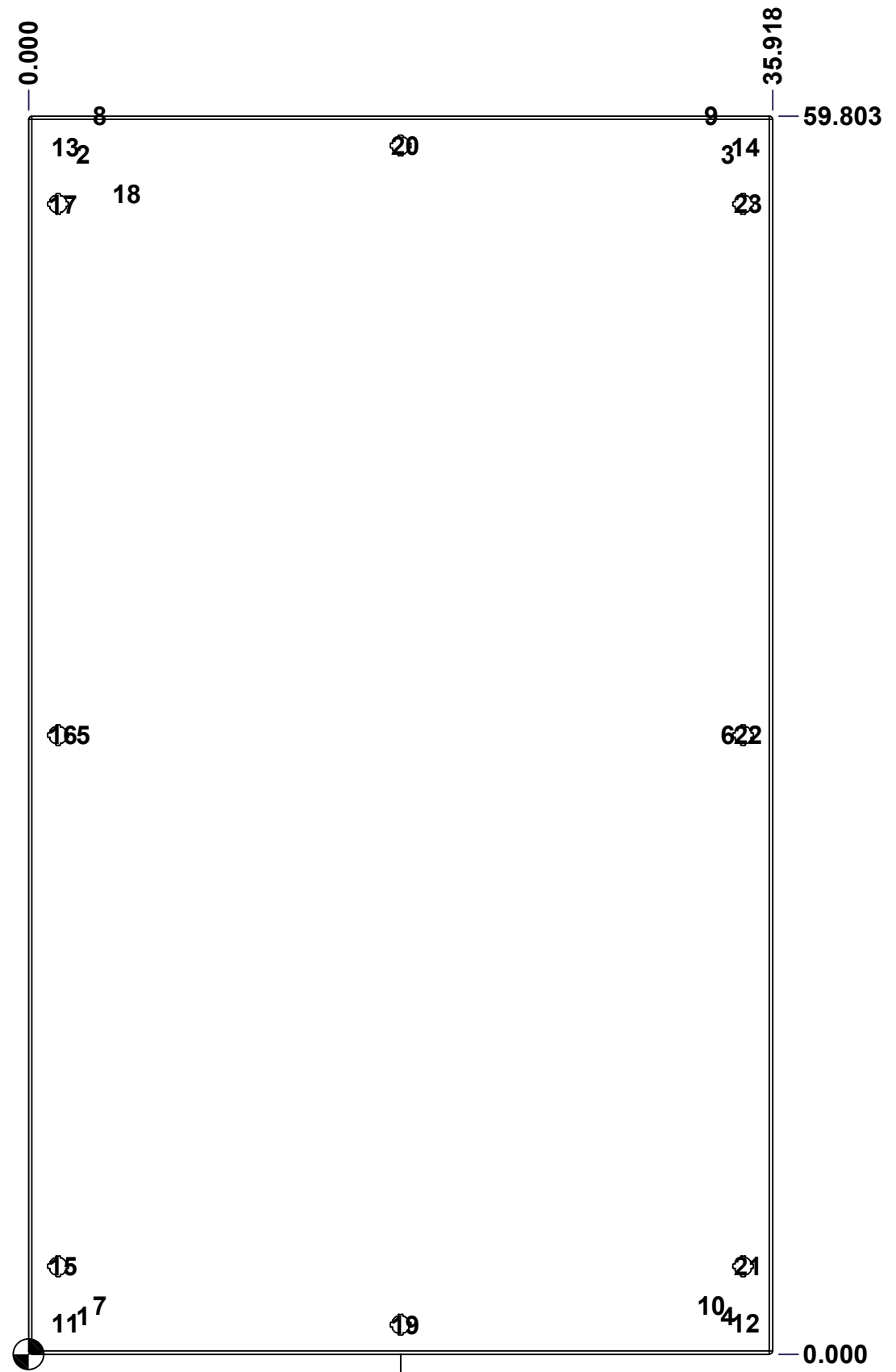

FRONT

	Description		Status
	5412ESSQT 60" x 36" Cover		(NULL)
Part Number		Rev.	8
Numéro Pièce		<b>0</b>	9
<b>5412ESSQT6036206C</b>			

This drawing is confidential and must not be reproduced or used without the consent of EXM

Ce dessin est confidentiel et ne doit pas être reproduit ou utilisé sans le consentement de EXM

No.	Revisions	Date	By/Par

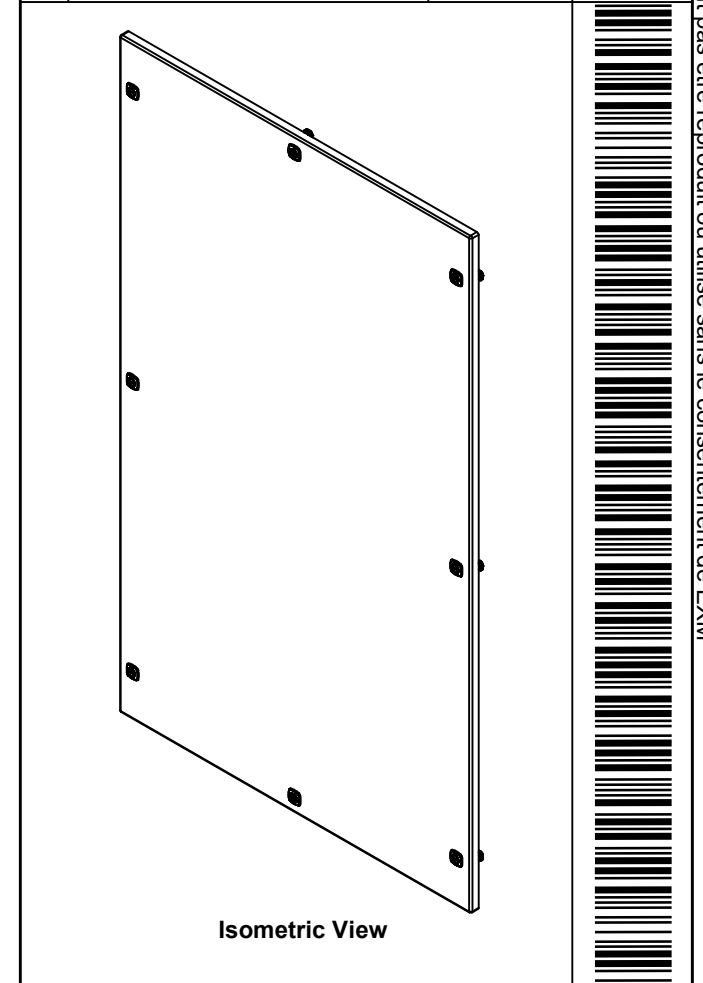

 Tél: (450) 979-4373  
 Fax: (450) 979-4626  
[www.exmweb.com](http://www.exmweb.com)

Flatness / Aplatissement: Max 3.0mm  
 Projection: 

Customer / Client	Date
Drawn By / Dessiné Par: BoxCad: BoxCad	Date: 03-Feb-26

Material / Matière: 14 Ga Stainless Steel 316 (1.7mm)

Color / Couleur: Unpainted	Finish / Fini: Brushed
----------------------------	------------------------

Description: 5412ESSQT 60" x 36" Cover	Detail Rev.
--	-------------

Part Number / Numéro Pièce: <b>5412ESSQT6036206C</b>	Rev. / Révis: <b>0</b>	9
--	------------------------	---

QTY	Part Number	Rev	Description
1	STK-S-00100	0	3.5" x 2" Silver Milar Flexcon Sticker
8	STK-K-12590	7	5412 ESS 1/4 Turn Lock
10	STK-Q-07220	1	M6 Nylon Insert Lock Nut
2	STK-Q-46025-36-3	6	5412 ES Horizontal Door Stiffener 36" (3 Pts)
2	STK-Q-46020-60	5	5412 ES Vertical Door Stiffener 60"
14	STK-Q-16070	1	Stud M6 x 18mm Stainless steel
1	5412ESSQT6036206G	0	5412ESSQT 60" x 36" Cover Gasket Part
1	5412ESSQT6036206C-P	0	5412ESSQT 60" x 36" Cover Part
4	STK-Q-46515	3	5412 ES Door Support with Brass Insert
Parts List			

This drawing is confidential and must not be reproduced or used without the consent of EXM

Ce dessin est confidentiel et ne doit pas être reproduit ou utilisé sans le consentement de EXM

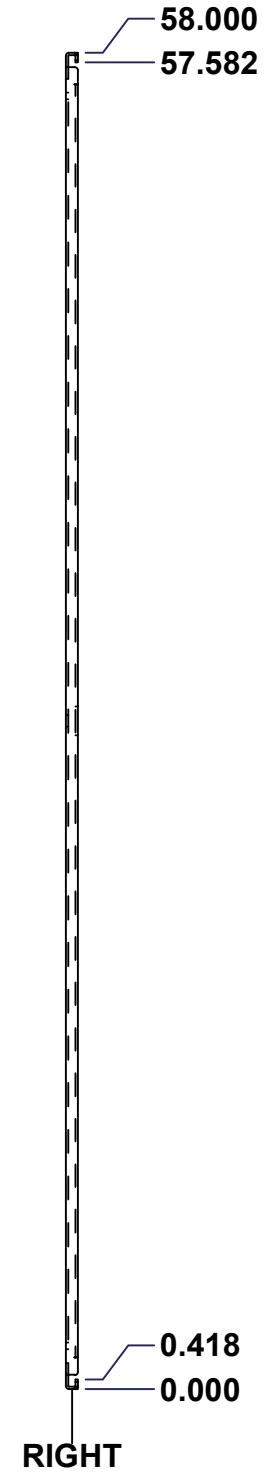
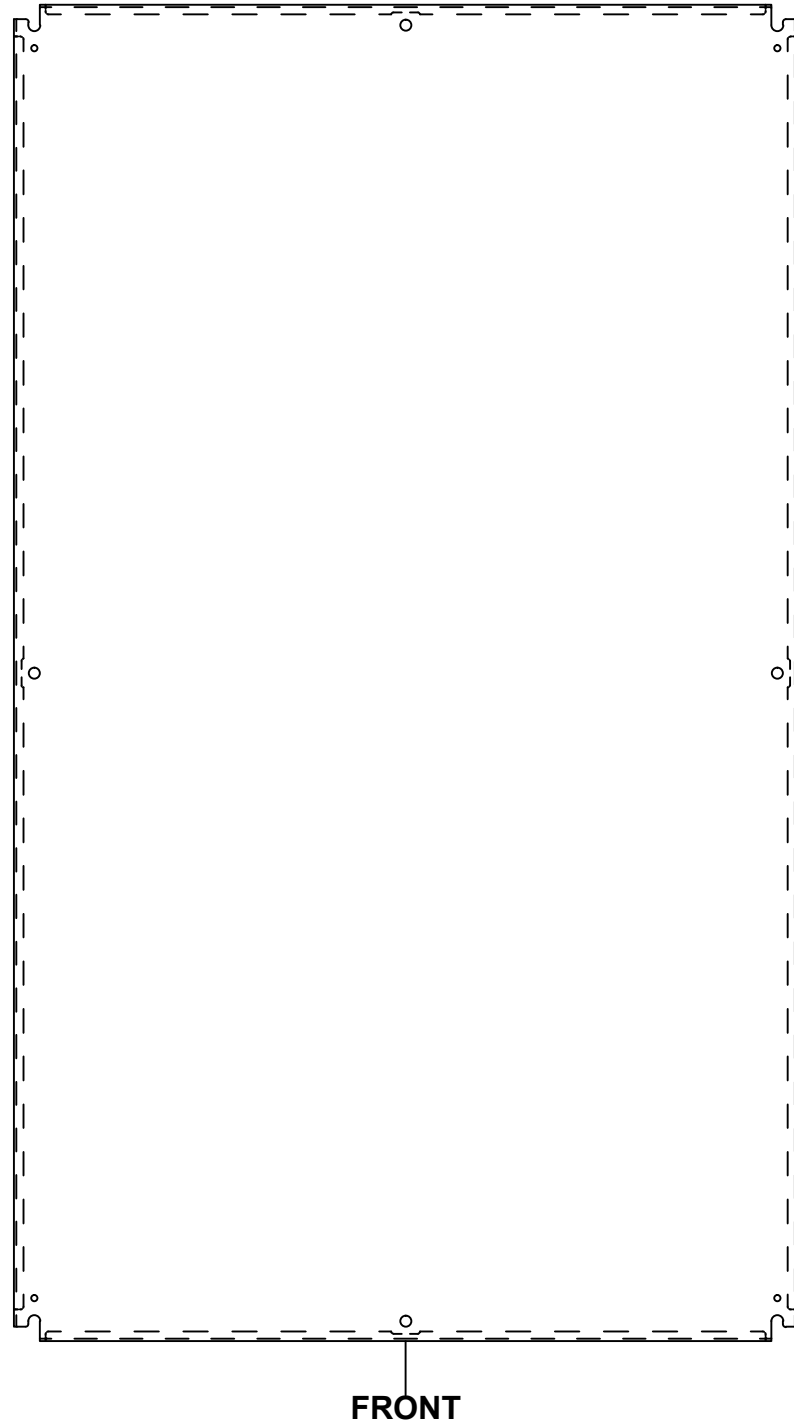
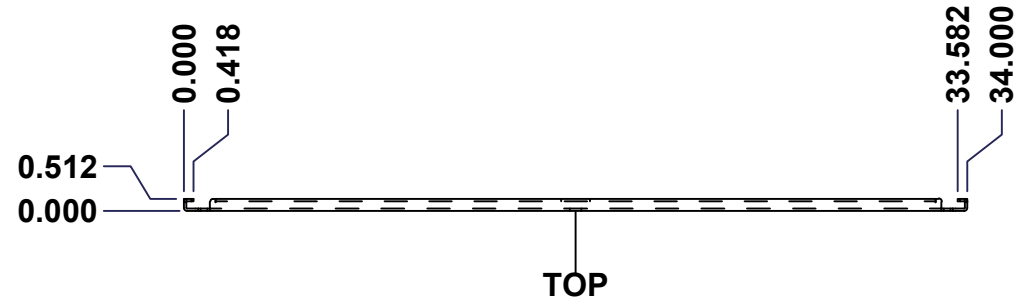

No.	Revisions	Date	By/Par

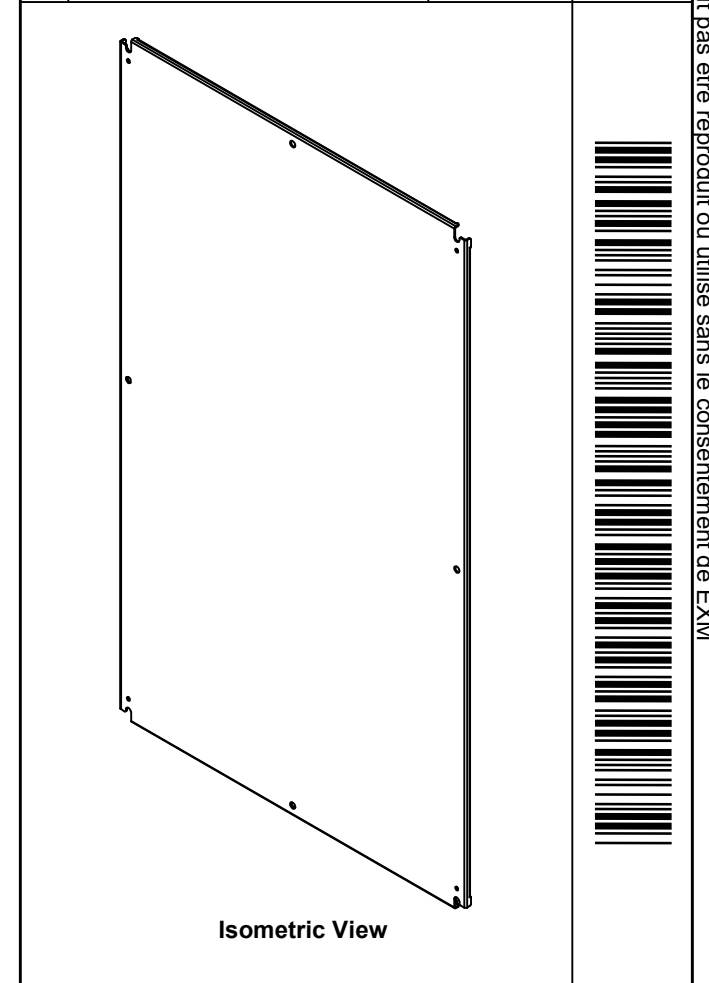

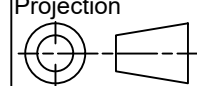
 Tél: (450) 979-4373 Fax: (450) 979-4626 www.exmweb.com		Flatness Aplatissement Max 3.0mm Projection 
Customer Client	Date	
Drawn By Dessiné Par: BoxCad	Date: 23-Jan-07	
Material Matière	See Part List	
Color Couleur	See Part List	Finish Fini: See Part List
Description: 881 SP - Inner Panel		Detail Rev.
Part Number Numéro Pièce: <b>881 SP6036G</b>	Rev. <b>0</b>	1/2

Qty	Part Number	Rev	Description	Material	Color	Finish
1	881 SP6036G-P	0	881 SP - Inner Panel Part	12 Ga Galvanized	Unpainted	Galvanized

Parts List

This drawing is confidential and must not be reproduced or used without the consent of EXM

Ce dessin est confidentiel et ne doit pas être reproduit ou utilisé sans le consentement de EXM

Table 1			FRONT VIEW
CUT-OUT	XDIM	YDIM	DESCRIPTION
1	17.000	0.875	MTG STUD HOLE (RND Ø0.500)
2	0.875	29.000	MTG STUD HOLE (RND Ø0.500)
3	33.125	29.000	MTG STUD HOLE (RND Ø0.500)
4	17.000	57.125	MTG STUD HOLE (RND Ø0.500)
5	0.875	1.875	GROUND HOLE (RND Ø0.290)
6	33.125	1.875	GROUND HOLE (RND Ø0.290)
7	0.875	56.125	GROUND HOLE (RND Ø0.290)
8	33.125	56.125	GROUND HOLE (RND Ø0.290)

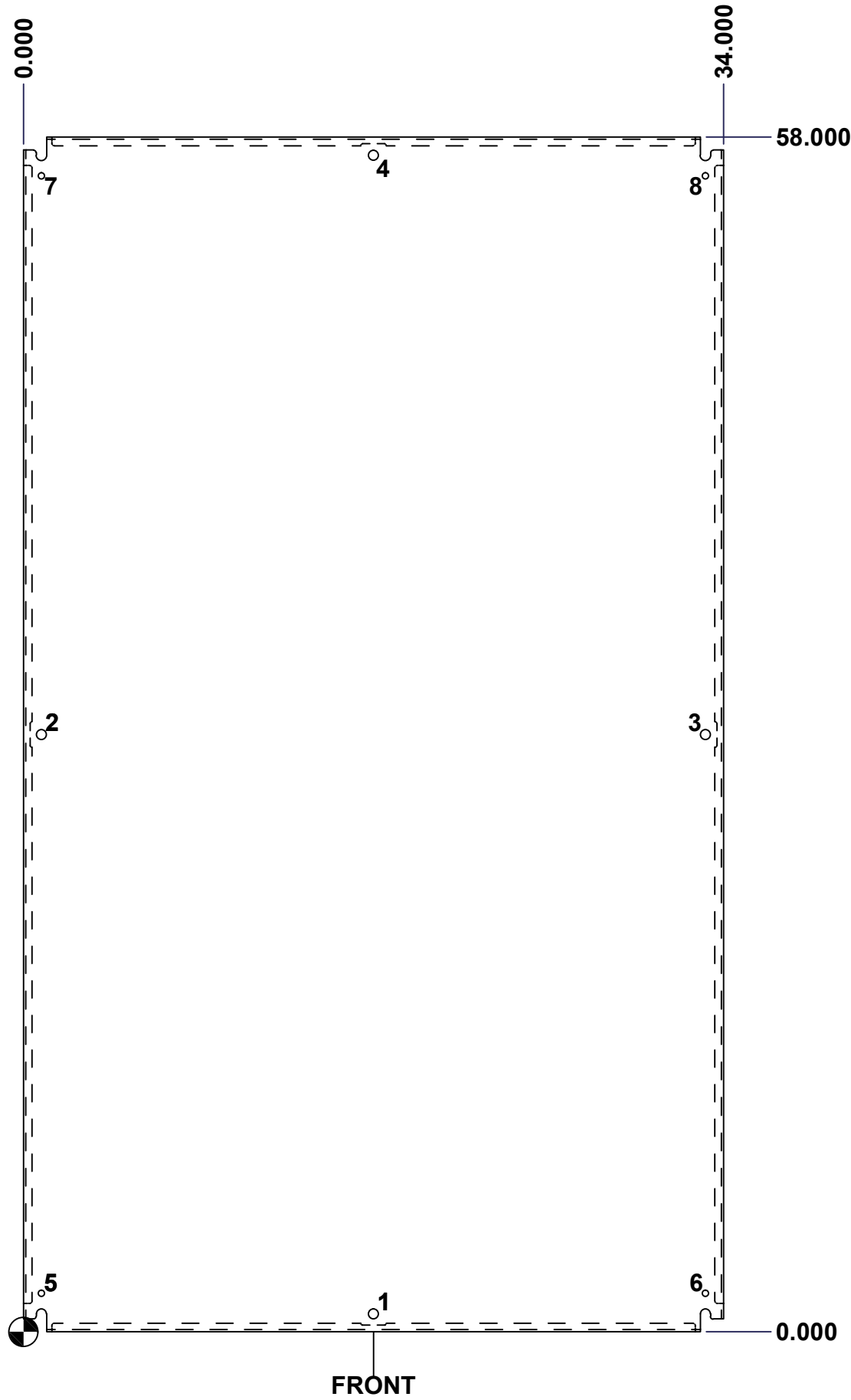

All knockouts are actual size / Les disques défonçables sont grandeur réel

No.	Revisions	Date	By/Par

Isometric View

		Tél: (450) 979-4373 Fax: (450) 979-4626 www.exmweb.com		Flatness Aplatissement Max 3.0mm	
Customer Client		Date		Projection 	
Drawn By Dessiné Par		BoxCad		Date 23-Jan-07	
Material Matière		See Part List			
Color Couleur		See Part List		Finish Fini	
Description 881 SP - Inner Panel				Detail Rev.	
Part Number Numéro Pièce <b>881 SP6036G</b>				Rev. 2 <b>0</b>	