

This drawing is confidential and must not be reproduced or used without the consent of EXM

Ce dessin est confidentiel et ne doit pas être reproduit ou utilisé sans le consentement de EXM

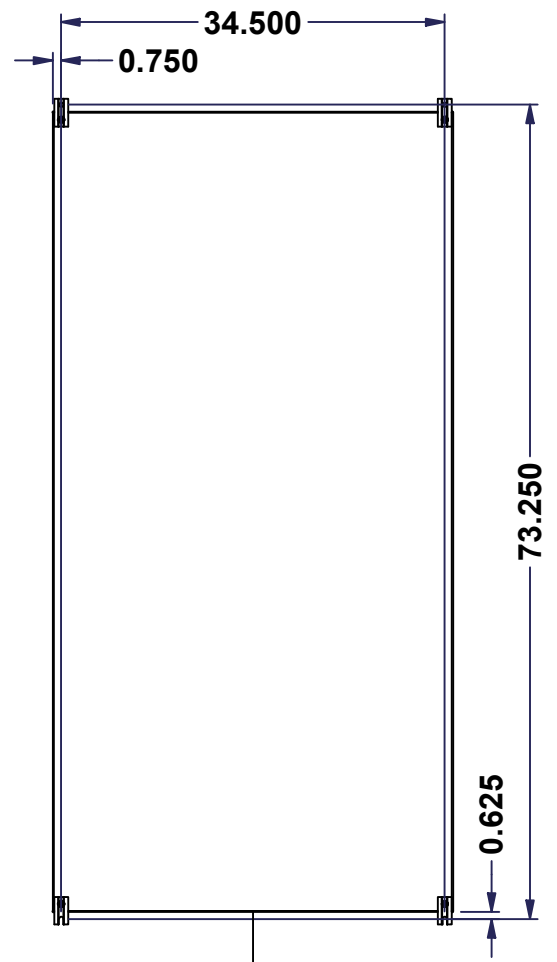

TOP



BACK

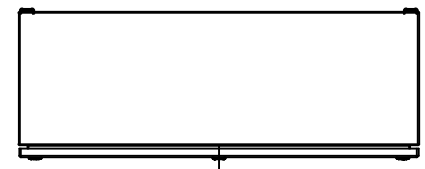

BOTTOM

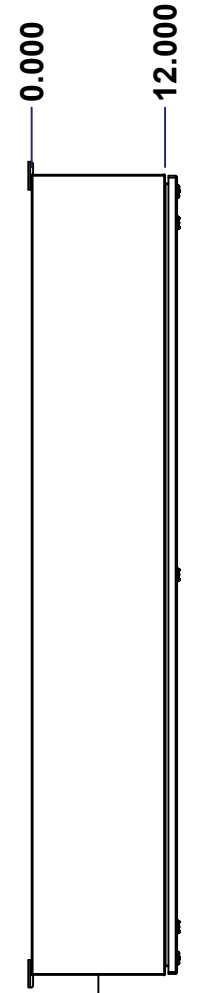

LEFT

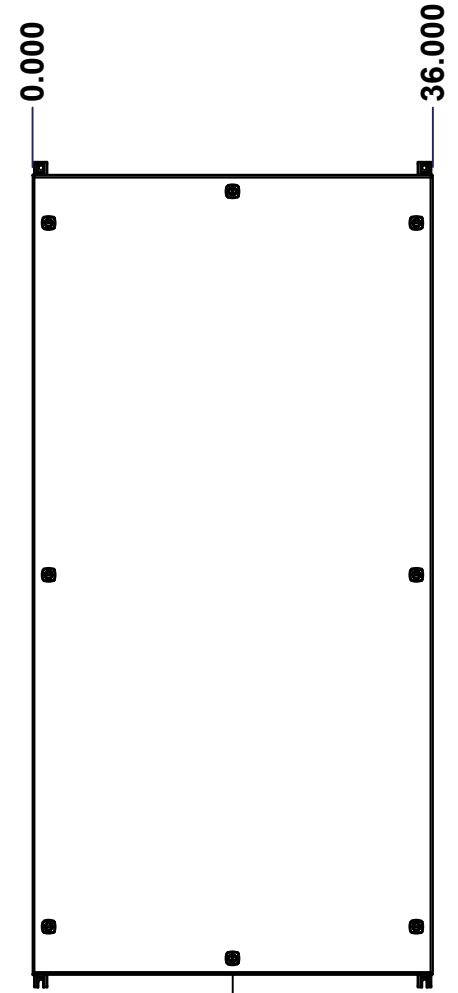

FRONT

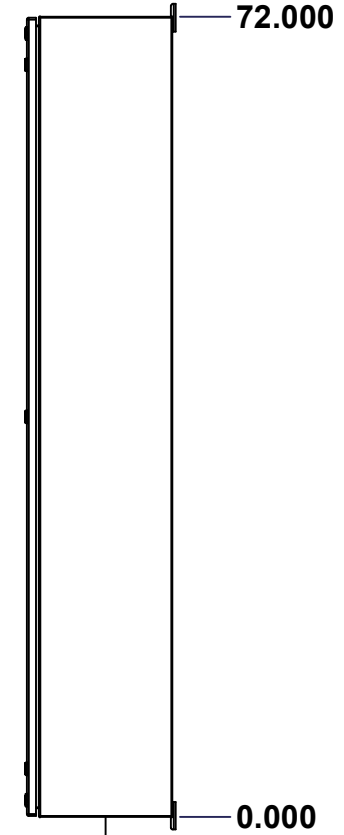

RIGHT

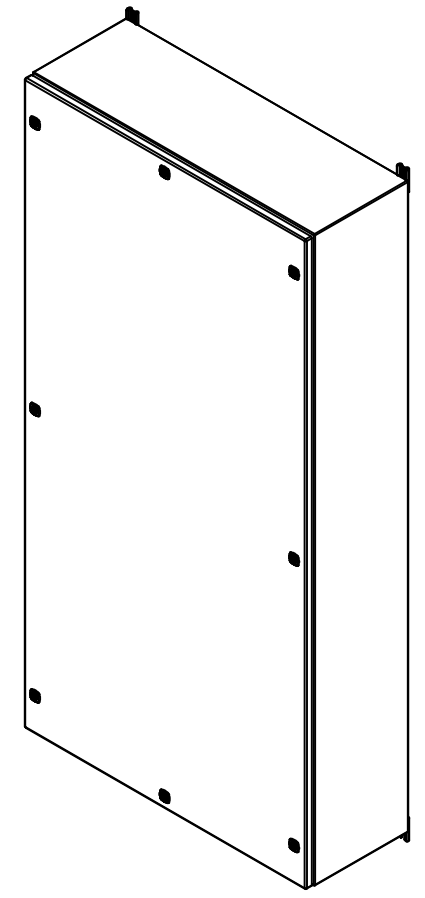

Isometric View



**GRAIN DIRECTION:
TOP/BOTTOM: HORIZONTAL
LEFT/RIGHT/BACK/FRONT: VERTICAL**

| No. | Revisions | Date | By/Par |
|-----|-----------|------|--------|
| | | | |
| | | | |
| | | | |
| | | | |

| | | |
|--|-----------------------------------|--|
| Tél: (450) 979-4373 Fax: (450) 979-4626 www.exmweb.com | | Flatness Aplatissement Max 3.0mm Projection |
| Customer Client | Date | |
| Drawn By Dessiné Par | BoxCad: BoxCad | Date 26-Feb-26 |
| Material Matière | 14 Ga Stainless Steel 316 (1.7mm) | |
| Color Couleur | Unpainted | Finish Fini Brushed |
| Description | Detail Rev. | |
| 5412ESSQT 72" x 36" x 12" Assembly | | |
| Part Number Numéro Pièce | Rev. | 1 |
| SEE BILL OF MATERIAL ON LAST PAGE | 5412ESSQT7236126TH | 0 |

This drawing is confidential and must not be reproduced or used without the consent of EXM

Ce dessin est confidentiel et ne doit pas être reproduit ou utilisé sans le consentement de EXM

| NOTE | |
|------|---|
| ITEM | DESCRIPTION |
| 1 | NEMA 4X Enclosure (IP66) |
| 2 | C/W Standard ground studs on box and cover |
| 3 | C/W Standard door stiffener |
| 4 | C/W Standard inner panel (Included) |
| 5 | C/W Standard inner panel mounting studs |
| 6 | C/W 885 ESMF4_OPEN Sold separately (Installed) |
| 7 | C/W 885 ESMF4_CLOSE Sold separately (Installed) |
| 8 | C/W R5 Insulation (Installed aluminum visible) |

| No. | Revisions | Date | By/Par |
|-----|-----------|------|--------|
| | | | |
| | | | |
| | | | |
| | | | |
| | | | |

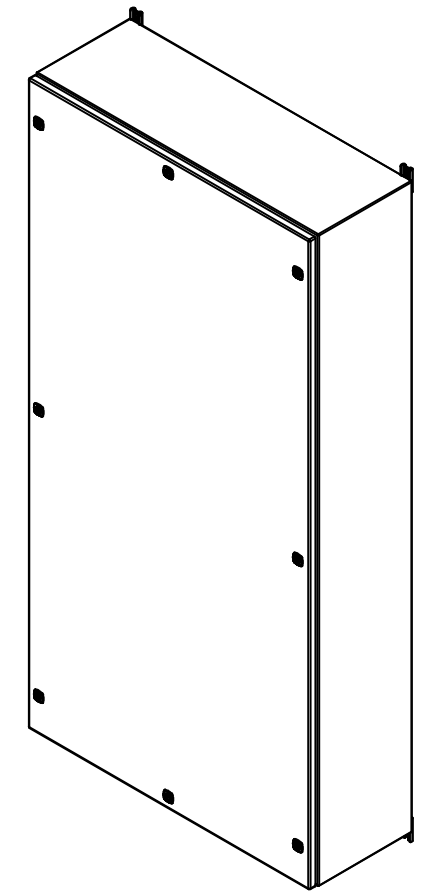

Isometric View



| PACKING | | |
|-----------------------|-----|--|
| ITEM | QTY | DESCRIPTION |
| Cardboard sleeve | 2 | Top and Bottom |
| Cardboard strip | 2 | Between back of enclosure and inner panel |
| Plastic bag | 1 | To protect cover surface and inside gasket |
| Cardboard corner | 4 | To reinforced for the plastic strap tightening |
| Plastic strap - Black | 2 | To Squeeze the 2 cardboard sleeve together |
| Packaging label | 3 | White label with PN |
| Plastic strap- Green | 2 | To secure the enclosure to the wood pallet |
| Wood Pallet | 1 | 2" deeper and 3" larger than enclosure size |

| Qty | Part Number | Rev | Description |
|-----|---------------------|-----|--------------------------------|
| 1 | STK-K-01800 | 5 | 5412 ES Accessory Kit |
| 8 | STK-Q-00600 | 2 | M12 to M8 Adaptor |
| 1 | 881 SP7236G | 0 | 881 SP - Inner Panel |
| 1 | 5412ESSQT7236126THC | 0 | 5412ESSQT 72" x 36" Cover |
| 1 | 5412ESSQT7236126THB | 0 | 5412ESSQT 72" x 36" x 12" Body |

Parts List

| | | | |
|--|--|--|---------|
| | | Flatness Aplatissement Max 3.0mm Projection | |
| Tél: (450) 979-4373 Fax: (450) 979-4626 www.exmweb.com | | Customer Client Date | |
| Drawn By Dessiné Par BoxCad: BoxCad | | Date 26-Feb-26 | |
| Material Matière 14 Ga Stainless Steel 316 (1.7mm) | | Color Couleur Unpainted | |
| Finish Fini Brushed | | Description 5412ESSQT 72" x 36" x 12" Assembly | |
| Part Number Numéro Pièce 5412ESSQT7236126TH | | Rev. 0 | 2 16 |

This drawing is confidential and must not be reproduced or used without the consent of EXM

Ce dessin est confidentiel et ne doit pas être reproduit ou utilisé sans le consentement de EXM

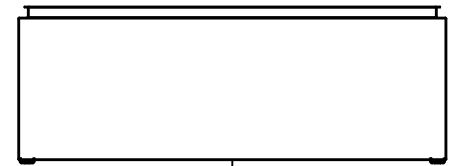

TOP

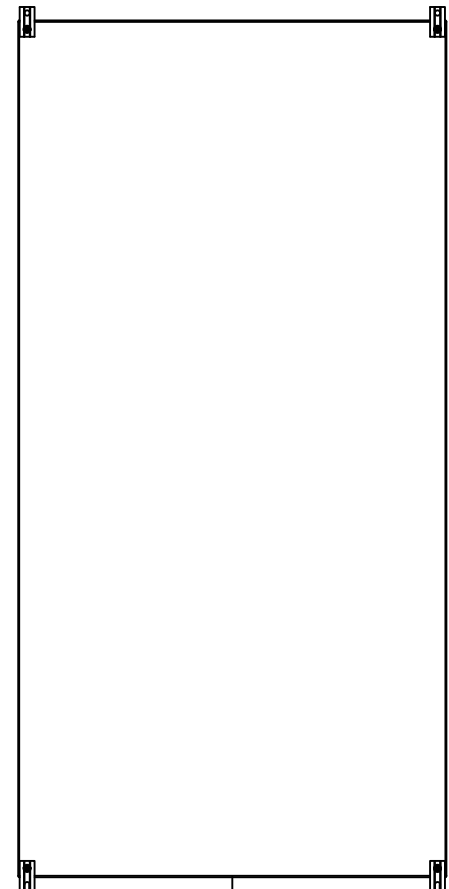

BACK

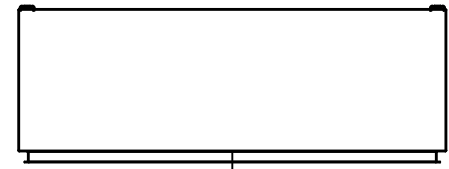

BOTTOM

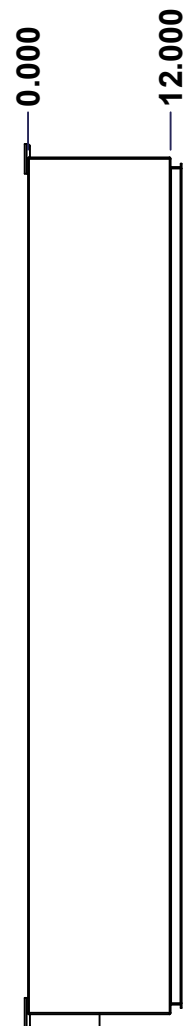

LEFT

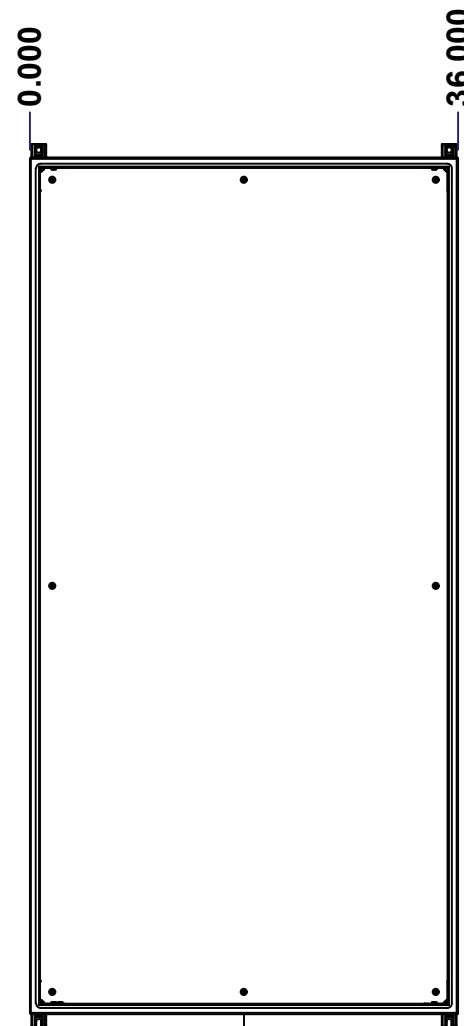

FRONT

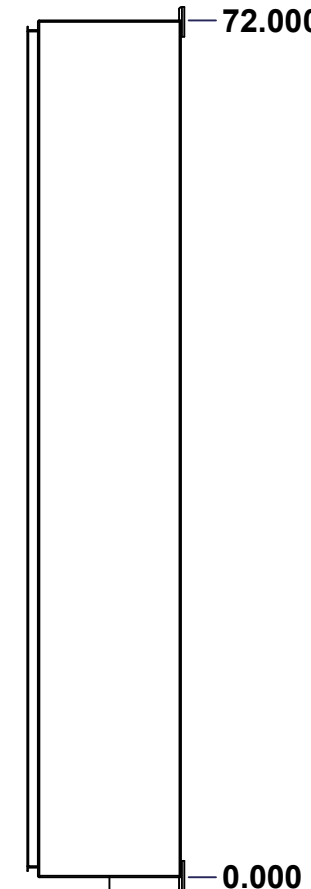

RIGHT

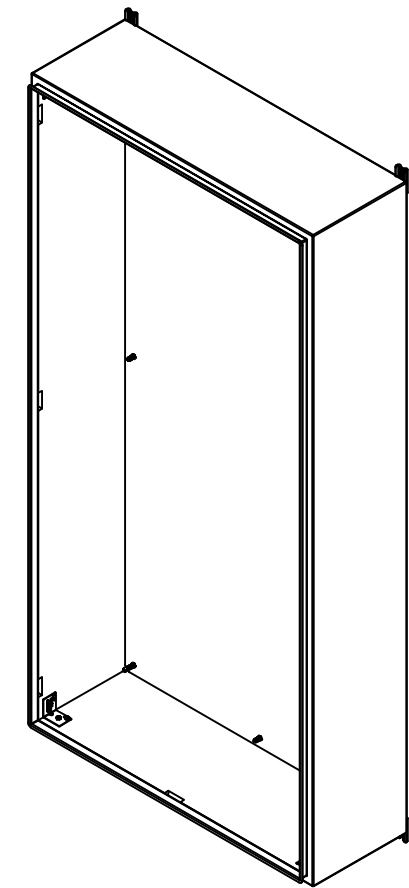

Isometric View

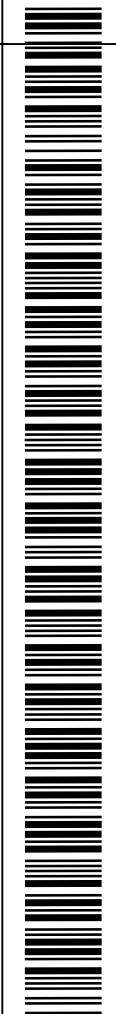

| No. | Revisions | Date | By/Par |
|-----|-----------|------|--------|
| | | | |
| | | | |
| | | | |
| | | | |

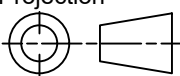
| | | |
|--|-----------------------------------|---|
|  Tél: (450) 979-4373 Fax: (450) 979-4626 www.exmweb.com | | Flatness Aplatissement Max 3.0mm Projection  |
| Customer Client | Date | |
| Drawn By Dessiné Par | BoxCad: BoxCad | Date 26-Feb-26 |
| Material Matière | 14 Ga Stainless Steel 316 (1.7mm) | |
| Color Couleur | Unpainted | Finish Fini Brushed |
| Description | Detail Rev. | |
| 5412ESSQT 72" x 36" x 12" Body | | |
| Part Number Numéro Pièce | Rev. 0 | 3 / 16 |

SEE BILL OF MATERIAL ON LAST PAGE

5412ESSQT7236126THB

This drawing is confidential and must not be reproduced or used without the consent of EXM

Ce dessin est confidentiel et ne doit pas être reproduit ou utilisé sans le consentement de EXM

| STANDARD FEATURES ARE NOT LISTED IN THIS HOLE TABLE | | | |
|---|--------|--------|--------------------------------|
| HOLE TABLE - TOP VIEW (CUSTOM FEATURE ONLY) | | | |
| CUT-OUT | XDIM | YDIM | DESCRIPTION |
| 1 | 1.500 | 11.250 | INSUL. STUD M6 x 18mm (Inside) |
| 2 | 34.500 | 11.250 | INSUL. STUD M6 x 18mm (Inside) |

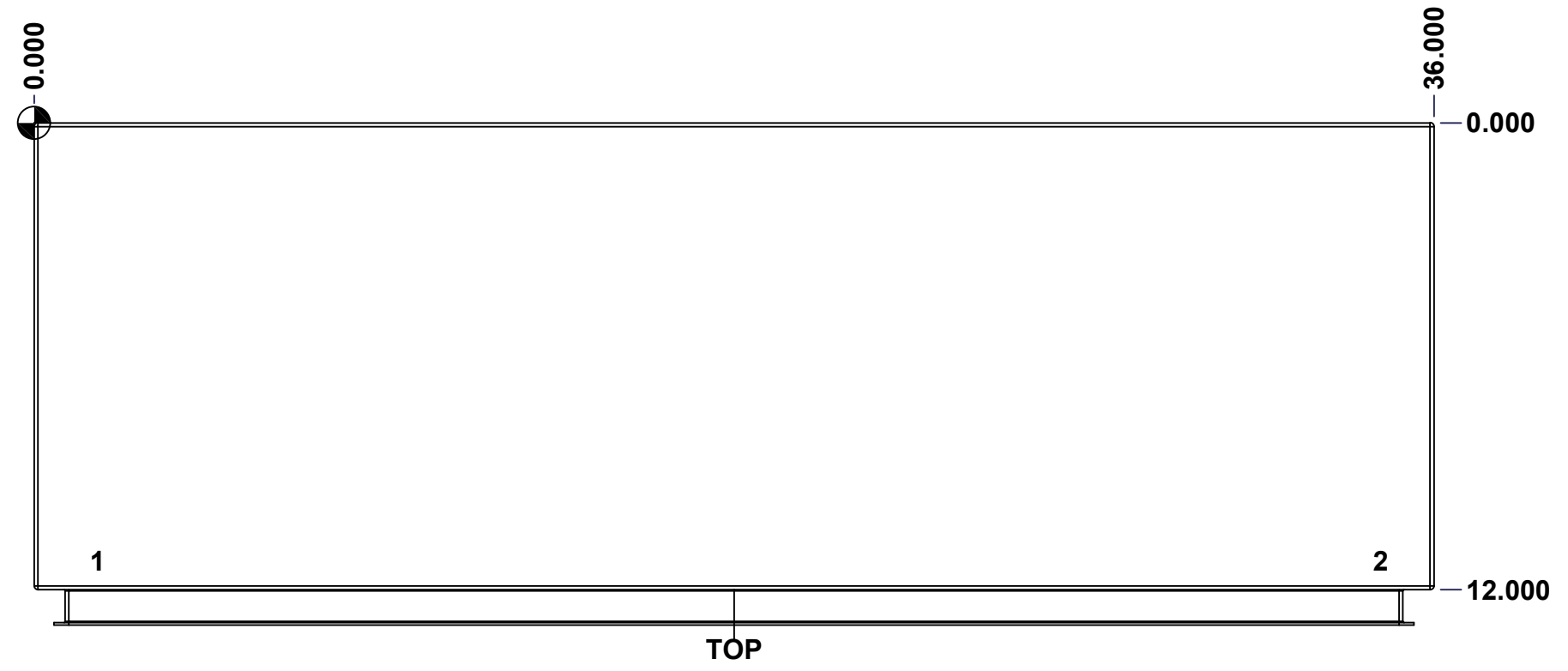

| | | | |
|--|--------------------------------|----------|----|
| | Description | Status | |
| | 5412ESSQT 72" x 36" x 12" Body | (NULL) | |
| | Part Number Numéro Pièce | Rev. | 4 |
| | 5412ESSQT7236126THB | 0 | 16 |

This drawing is confidential and must not be reproduced or used without the consent of EXM

Ce dessin est confidentiel et ne doit pas être reproduit ou utilisé sans le consentement de EXM

| STANDARD FEATURES ARE NOT LISTED IN THIS HOLE TABLE | | | |
|--|--------|--------|--------------------------------|
| HOLE TABLE - BOTTOM VIEW (CUSTOM FEATURE ONLY) | | | |
| CUT-OUT | XDIM | YDIM | DESCRIPTION |
| 1 | 2.000 | 10.500 | INSUL. STUD M6 x 18mm (Inside) |
| 2 | 34.000 | 10.500 | INSUL. STUD M6 x 18mm (Inside) |

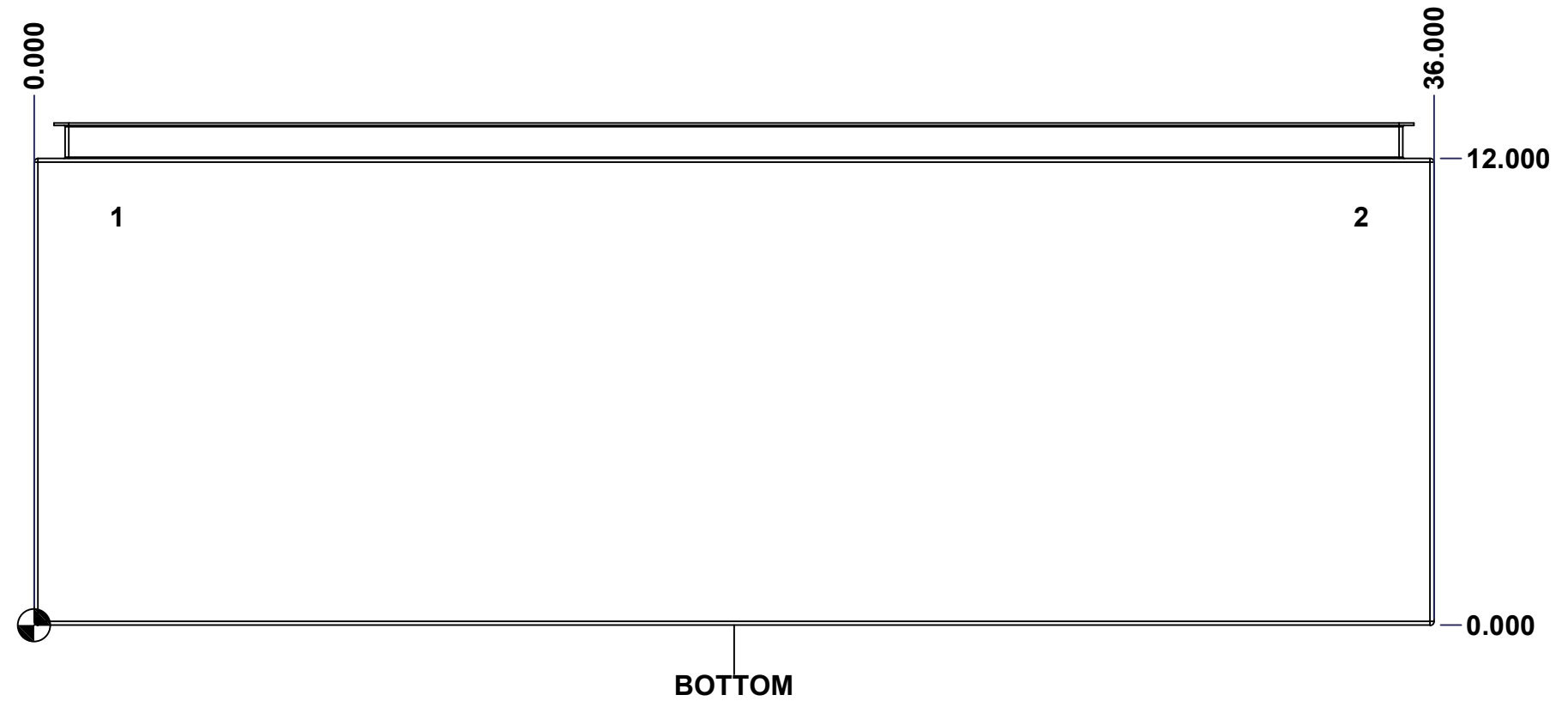

| | | |
|--|--------------------------------|----------|
| | Description | Status |
| | 5412ESSQT 72" x 36" x 12" Body | (NULL) |
| | Part Number Numéro Pièce | Rev. |
| | 5412ESSQT7236126THB | 0 |
| | | 5 |
| | | 16 |

This drawing is confidential and must not be reproduced or used without the consent of EXM

Ce dessin est confidentiel et ne doit pas être reproduit ou utilisé sans le consentement de EXM

STANDARD FEATURES ARE NOT LISTED IN THIS HOLE TABLE

HOLE TABLE - BACK VIEW (CUSTOM FEATURE ONLY)

| CUT-OUT | XDIM | YDIM | DESCRIPTION |
|---------|--------|--------|----------------------------|
| 1 | 1.875 | 1.875 | IP STUD M8 x 35mm (Inside) |
| 2 | 1.875 | 70.125 | IP STUD M8 x 35mm (Inside) |
| 3 | 34.125 | 70.125 | IP STUD M8 x 35mm (Inside) |
| 4 | 34.125 | 1.875 | IP STUD M8 x 35mm (Inside) |
| 5 | 18.000 | 1.875 | IP STUD M8 x 35mm (Inside) |
| 6 | 18.000 | 70.125 | IP STUD M8 x 35mm (Inside) |
| 7 | 1.875 | 36.000 | IP STUD M8 x 35mm (Inside) |
| 8 | 34.125 | 36.000 | IP STUD M8 x 35mm (Inside) |
| ----- | | | |
| 9 | 0.750 | 0.000 | FOOT 885 ESMF4_OPEN |
| 10 | 0.750 | 72.000 | FOOT 885 ESMF4_CLOSE |
| 11 | 35.250 | 0.000 | FOOT 885 ESMF4_OPEN |
| 12 | 35.250 | 72.000 | FOOT 885 ESMF4_CLOSE |

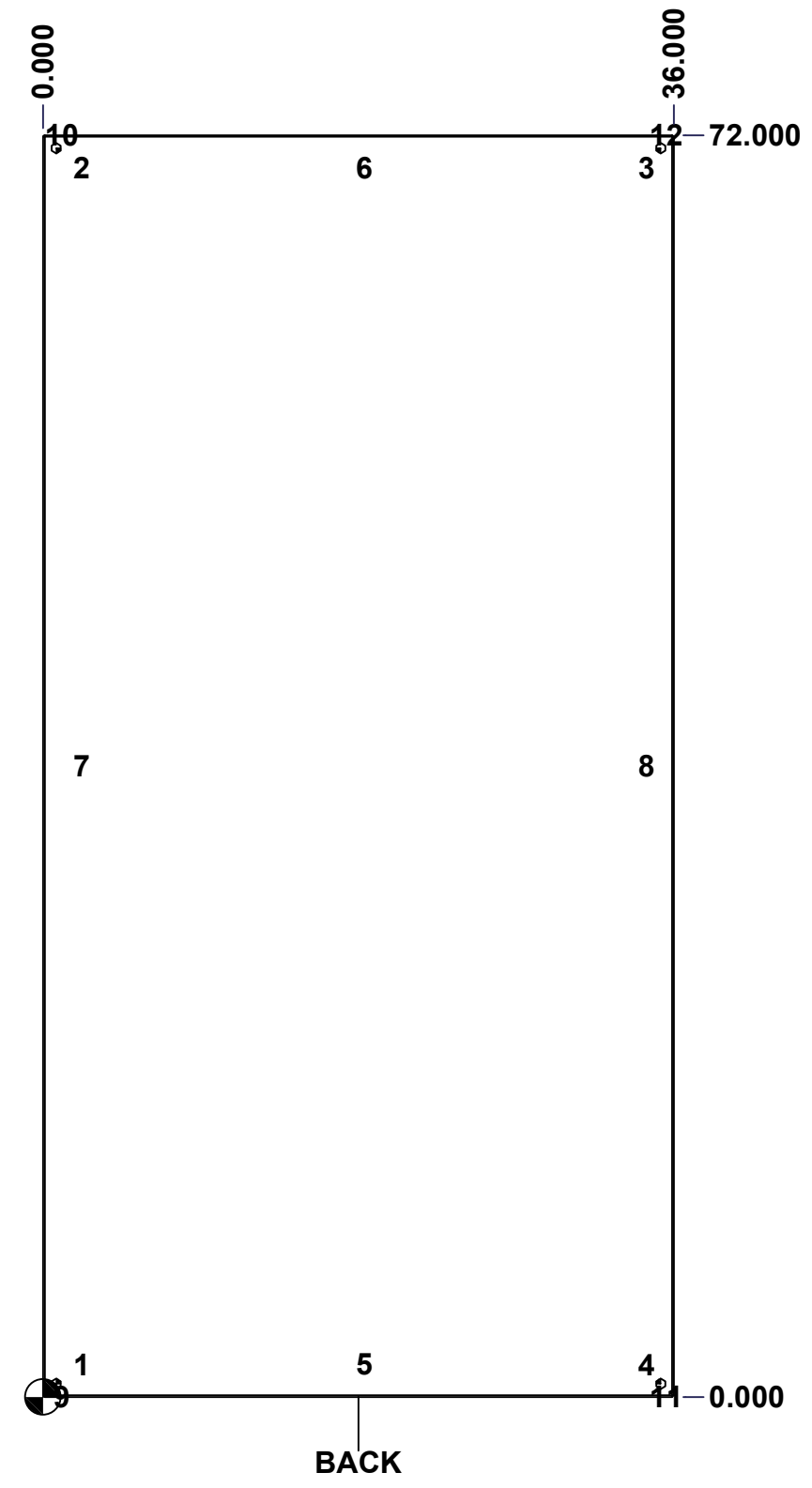

| | | |
|--|--------------------------------|--------------|
| | Description | Status |
| | 5412ESSQT 72" x 36" x 12" Body | (NULL) |
| | Part Number Numéro Pièce | Rev. |
| | 5412ESSQT7236126THB | 0 / 6 |

This drawing is confidential and must not be reproduced or used without the consent of EXM

Ce dessin est confidentiel et ne doit pas être reproduit ou utilisé sans le consentement de EXM

| No. | Revisions | Date | By/Par |
|-----|-----------|------|--------|
| | | | |
| | | | |
| | | | |
| | | | |
| | | | |

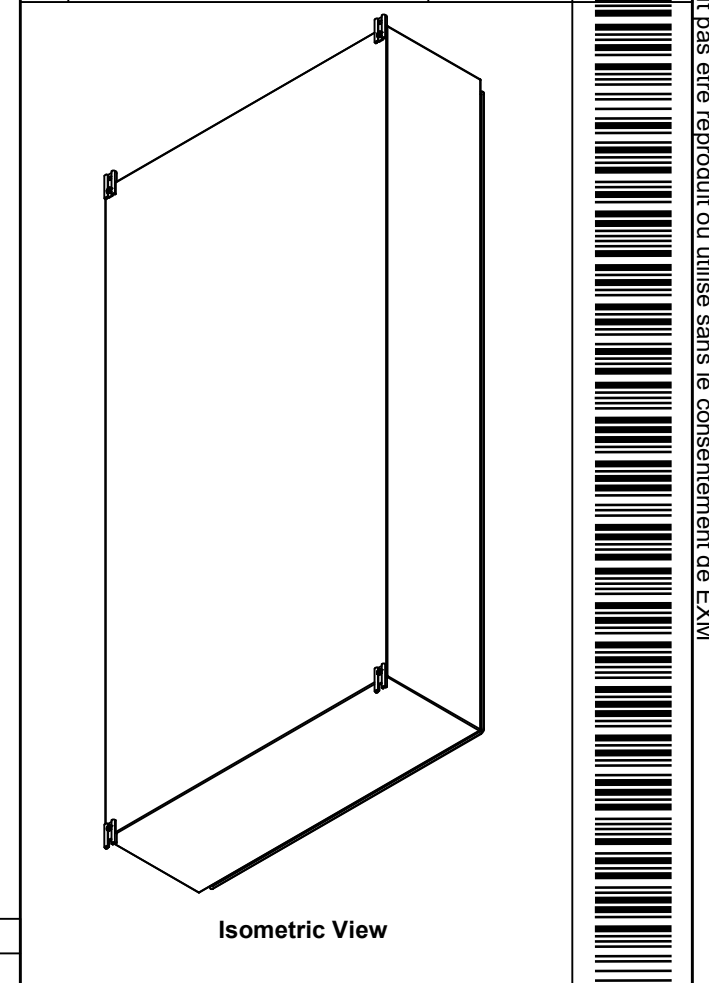

| | | | |
|------------|------------------------|-----|---|
| 1 | 885 ESMF4 | 0 | 885 ESMF4 Mounting Foot Kit |
| 1 | STK-K-70554 | 3 | 5412 ESTH Accessory Kit |
| 1 | 5412ESSQT7236126TH-RS | 0 | 5412ESSQT 72" x 36" Right Insulation |
| 1 | 5412ESSQT7236126TH-LS | 0 | 5412ESSQT 72" x 36" Left Insulation |
| 1 | 5412ESSQT7236126TH-BT | 0 | 5412ESSQT 72" x 36" Bottom Insulation |
| 1 | 5412ESSQT7236126TH-TP | 0 | 5412ESSQT 72" x 36" Top Insulation |
| 1 | 5412ESSQT7236126TH-B | 0 | 5412ESSQT 72" x 36" Back Insulation |
| 4 | STK-Q-16070 | 1 | Stud M6 x 18mm Stainless steel |
| 4 | RIVET_NUT_SS_M10_FH_CE | 0 | Stainless Steel Rivet Nut M10 (Low Profile Close End) |
| 8 | STK-Q-16020 | 1 | Stud M8 x 35mm Stainless Steel |
| 1 | 5412ESSQT7236126THB-P | 0 | 5412ESSQT 72" x 36" x 12" Body Part |
| Qty | Part Number | Rev | Description |
| Parts List | | | |

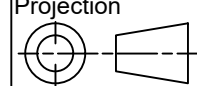
| | | |
|--|-----------------------------------|---|
|  Tél: (450) 979-4373 Fax: (450) 979-4626 www.exmweb.com | | Flatness Aplatissement Max 3.0mm Projection  |
| Customer Client | Date | |
| Drawn By Dessiné Par | BoxCad: BoxCad | Date 26-Feb-26 |
| Material Matière | 14 Ga Stainless Steel 316 (1.7mm) | |
| Color Couleur | Unpainted | Finish Fini Brushed |
| Description 5412ESSQT 72" x 36" x 12" Body | | Detail Rev. |
| Part Number Numéro Pièce | Rev. 0 | 7 16 |
| 5412ESSQT7236126THB | | |

This drawing is confidential and must not be reproduced or used without the consent of EXM

Ce dessin est confidentiel et ne doit pas être reproduit ou utilisé sans le consentement de EXM

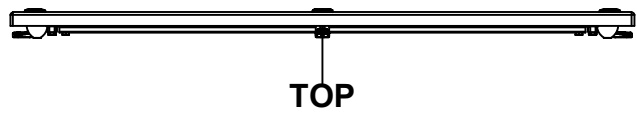

TOP

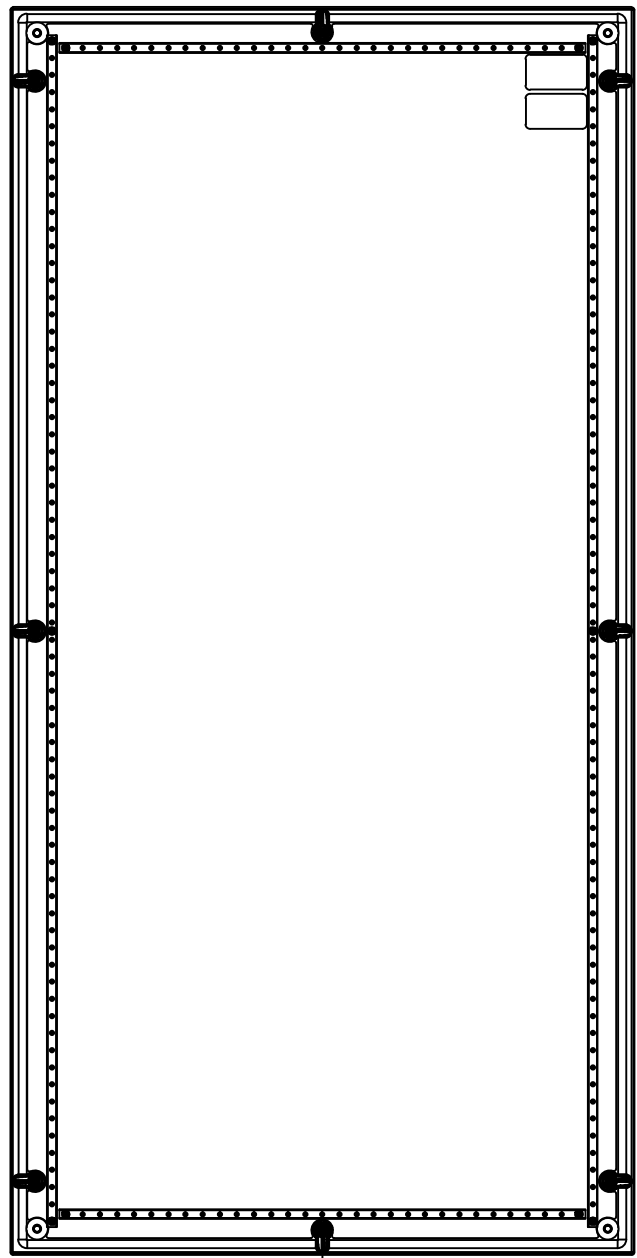

BACK



BOTTOM

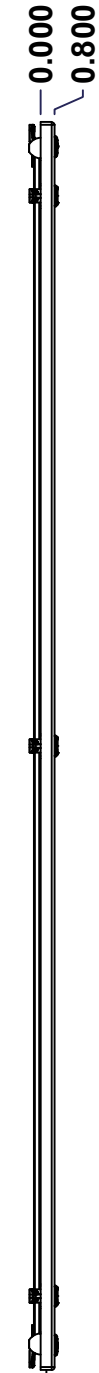

LEFT

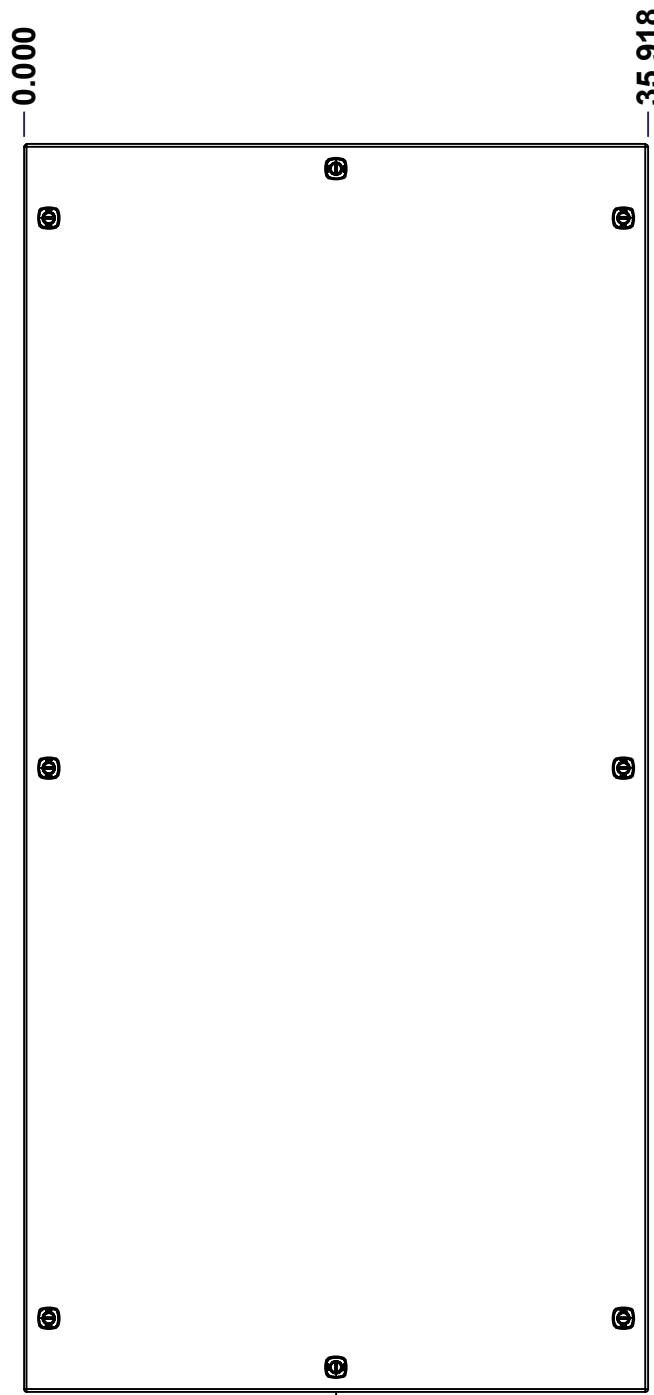

FRONT

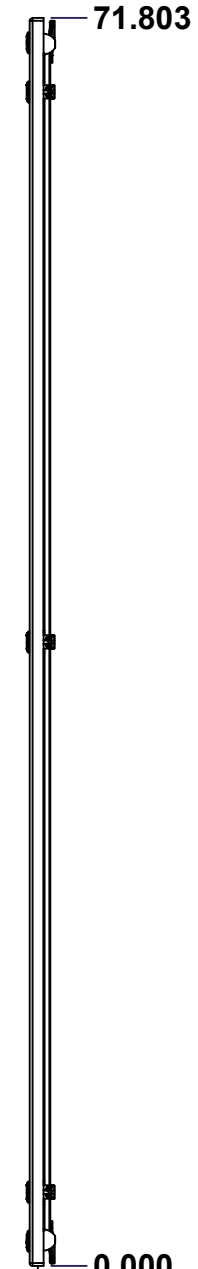

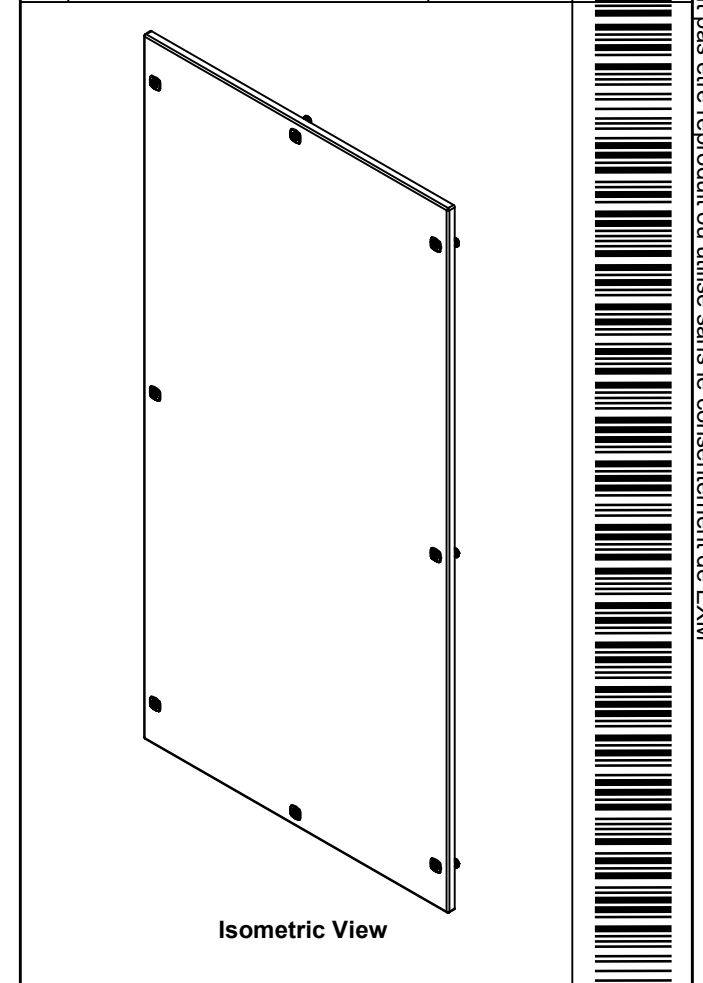

RIGHT

| No. | Revisions | Date | By/Par |
|-----|-----------|------|--------|
| | | | |
| | | | |
| | | | |
| | | | |

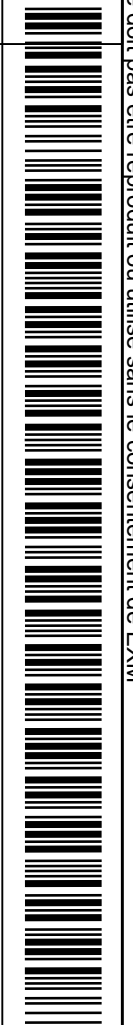

Isometric View

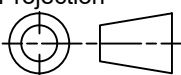

| | | |
|--|-----------------------------------|---|
|  Tél: (450) 979-4373 Fax: (450) 979-4626 www.exmweb.com | | Flatness Aplatissement Max 3.0mm Projection  |
| Customer Client | Date | |
| Drawn By Dessiné Par | BoxCad: BoxCad | Date 26-Feb-26 |
| Material Matière | 14 Ga Stainless Steel 316 (1.7mm) | |
| Color Couleur | Unpainted | Finish Fini Brushed |
| Description | Detail Rev. | |
| 5412ESSQT 72" x 36" Cover | | |
| Part Number Numéro Pièce | Rev. 0 | 8 / 16 |

SEE BILL OF MATERIAL ON LAST PAGE **5412ESSQT7236126THC**

This drawing is confidential and must not be reproduced or used without the consent of EXM

Ce dessin est confidentiel et ne doit pas être reproduit ou utilisé sans le consentement de EXM

STANDARD FEATURES ARE NOT LISTED IN THIS HOLE TABLE

HOLE TABLE - FRONT VIEW (CUSTOM FEATURE ONLY)

| CUT-OUT | XDIM | YDIM | DESCRIPTION |
|---------|--------|--------|------------------------------|
| 1 | 2.401 | 1.945 | STUD M6 x 18mm (Inside) |
| 2 | 2.401 | 69.858 | STUD M6 x 18mm (Inside) |
| 3 | 33.517 | 69.858 | STUD M6 x 18mm (Inside) |
| 4 | 33.517 | 1.945 | STUD M6 x 18mm (Inside) |
| 5 | 2.401 | 35.902 | STUD M6 x 18mm (Inside) |
| 6 | 33.517 | 35.902 | STUD M6 x 18mm (Inside) |
| 7 | 3.195 | 2.350 | STUD M6 x 18mm (Inside) |
| 8 | 3.195 | 71.803 | STUD M6 x 18mm (Inside) |
| 9 | 32.723 | 71.803 | STUD M6 x 18mm (Inside) |
| 10 | 32.723 | 2.350 | STUD M6 x 18mm (Inside) |
| 11 | 1.550 | 1.500 | STUD M6 x 18mm (Inside) |
| 12 | 34.368 | 1.500 | STUD M6 x 18mm (Inside) |
| 13 | 1.550 | 70.303 | STUD M6 x 18mm (Inside) |
| 14 | 34.368 | 70.303 | STUD M6 x 18mm (Inside) |
| ----- | | | |
| 15 | 1.424 | 4.250 | LOCK 880 SCQ4-SLSS6 @ 180.0° |
| 16 | 1.424 | 35.902 | LOCK 880 SCQ4-SLSS6 @ 180.0° |
| 17 | 1.424 | 67.553 | LOCK 880 SCQ4-SLSS6 @ 180.0° |
| 18 | 17.959 | 1.424 | LOCK 880 SCQ4-SLSS6 @ 270.0° |
| 19 | 17.959 | 70.379 | LOCK 880 SCQ4-SLSS6 @ 90.0° |
| 20 | 34.494 | 4.250 | LOCK 880 SCQ4-SLSS6 @ 0.0° |
| 21 | 34.494 | 35.902 | LOCK 880 SCQ4-SLSS6 @ 0.0° |
| 22 | 34.494 | 67.553 | LOCK 880 SCQ4-SLSS6 @ 0.0° |

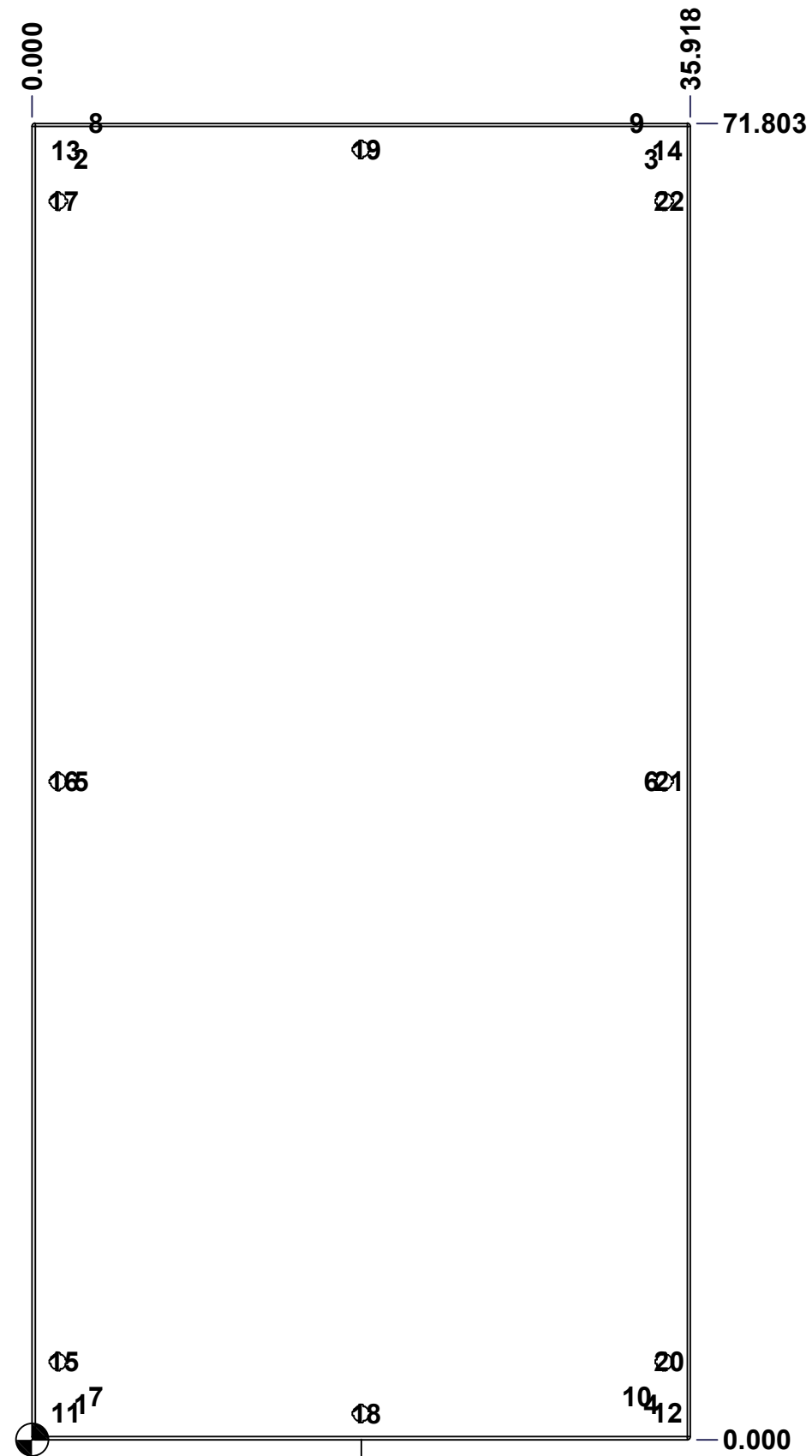

FRONT

| | | |
|--|-----------------------------|--------------|
| | Description | Status |
| | 5412ESSQT 72" x 36" Cover | (NULL) |
| | Part Number Numéro Pièce | Rev. |
| | 5412ESSQT7236126THC | 0 / 9 |
| | | 16 |

This drawing is confidential and must not be reproduced or used without the consent of EXM

Ce dessin est confidentiel et ne doit pas être reproduit ou utilisé sans le consentement de EXM

| No. | Revisions | Date | By/Par |
|-----|-----------|------|--------|
| | | | |
| | | | |
| | | | |
| | | | |
| | | | |

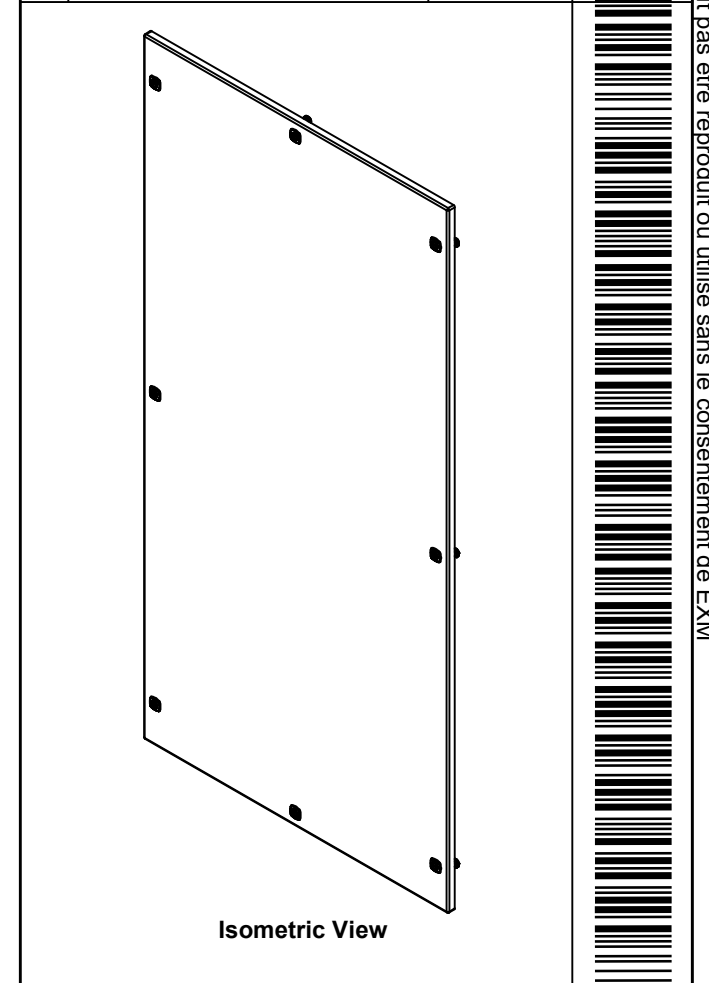

| | | | |
|------------|-----------------------|-----|---|
| 2 | STK-Q-46025-36-3 | 6 | 5412 ES Horizontal Door Stiffener 36" (3 Pts) |
| 10 | STK-Q-07250 | 2 | M6 x 16mm Collar Nut |
| 2 | STK-Q-46020-72 | 5 | 5412 ES Vertical Door Stiffener 72" |
| 2 | STK-S-00100 | 0 | 3.5" x 2" Silver Milar Flexcon Sticker |
| 1 | 5412ESSQT7236126THI-C | 0 | 5412ESSQT 72" x 36" Cover Insulation |
| 8 | STK-K-12590 | 7 | 5412 ESS 1/4 Turn Lock |
| 14 | STK-Q-16070 | 1 | Stud M6 x 18mm Stainless steel |
| 1 | 5412ESSQT7236126THG | 0 | 5412ESSQT 72" x 36" Cover Gasket Part |
| 1 | 5412ESSQT7236126THC-P | 0 | 5412ESSQT 72" x 36" Cover Part |
| 4 | STK-Q-46515 | 3 | 5412 ES Door Support with Brass Insert |
| QTY | Part Number | Rev | Description |
| Parts List | | | |

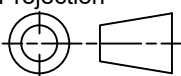
| | | |
|--|-----------------------------------|---|
|  Tél: (450) 979-4373 Fax: (450) 979-4626 www.exmweb.com | | Flatness Aplatissement Max 3.0mm Projection  |
| Customer Client | Date | |
| Drawn By Dessiné Par | BoxCad: BoxCad | Date 26-Feb-26 |
| Material Matière | 14 Ga Stainless Steel 316 (1.7mm) | |
| Color Couleur | Unpainted | Finish Fini Brushed |
| Description | | Detail Rev. |
| 5412ESSQT 72" x 36" Cover | | |
| Part Number Numéro Pièce | Rev. | 10 |
| 5412ESSQT7236126THC | 0 | 16 |

This drawing is confidential and must not be reproduced or used without the consent of EXM

Ce dessin est confidentiel et ne doit pas être reproduit ou utilisé sans le consentement de EXM

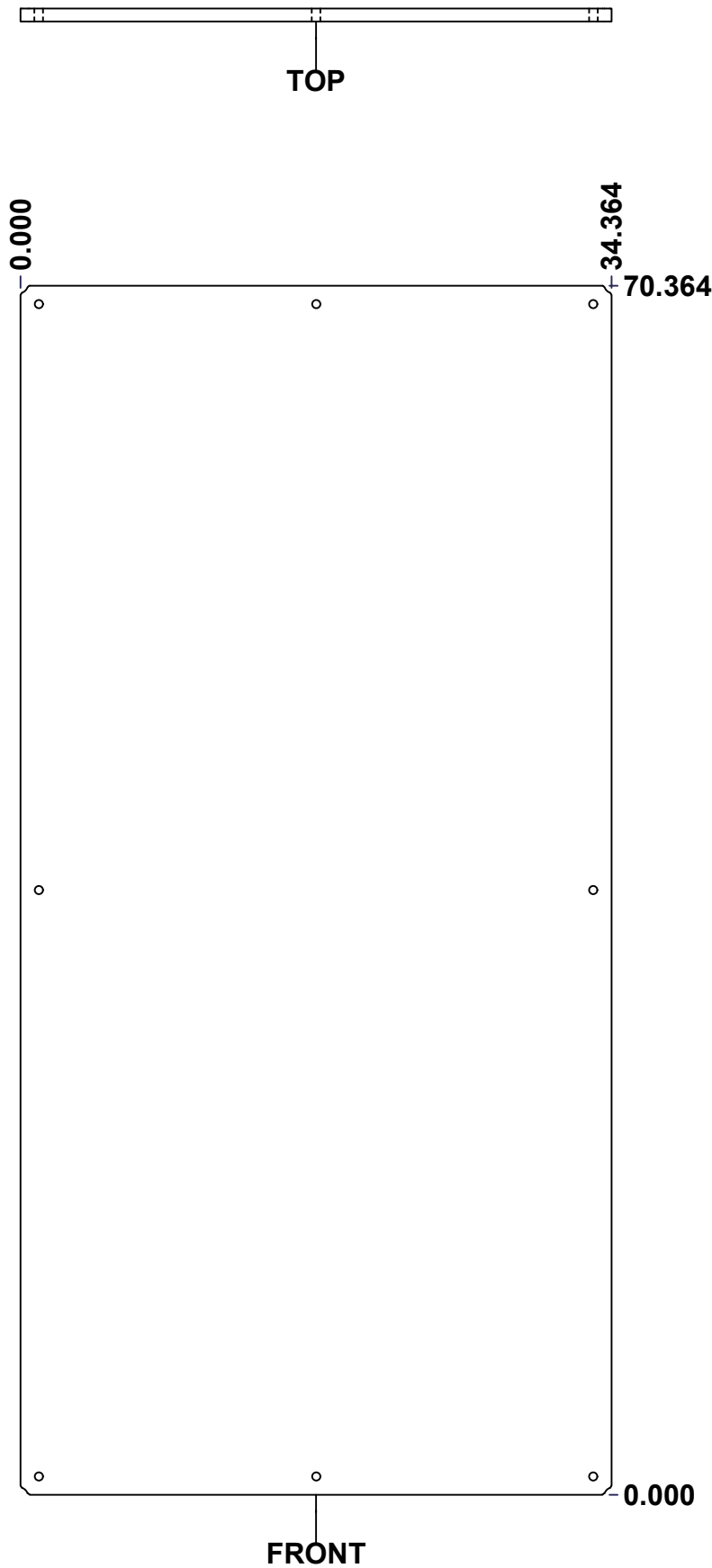

| No. | Revisions | Date | By/Par |
|-----|-----------|------|--------|
| | | | |
| | | | |
| | | | |
| | | | |

Isometric View

| | | |
|---|---------------------------|---------------------------|
| <p>Tél: (450) 979-4373 Fax: (450) 979-4626 www.exmweb.com</p> | | Flatness Aplatissement |
| | | Max 3.0mm |
| Projection | | |
| Customer Client | Date | |
| Drawn By Dessiné Par | BoxCad: Patrick Deschenes | Date 23-Jan-07 |
| Material Matière Polyisocyanurate | | |
| Color Couleur | Aluminum | Finish Fini N/A |
| Description 5412ESSQT 72" x 36" Back Insulation | | Detail Rev. |
| Part Number Numéro Pièce | Rev. 0 | 11 / 16 |

SEE BILL OF MATERIAL ON LAST PAGE

This drawing is confidential and must not be reproduced or used without the consent of EXM

Ce dessin est confidentiel et ne doit pas être reproduit ou utilisé sans le consentement de EXM

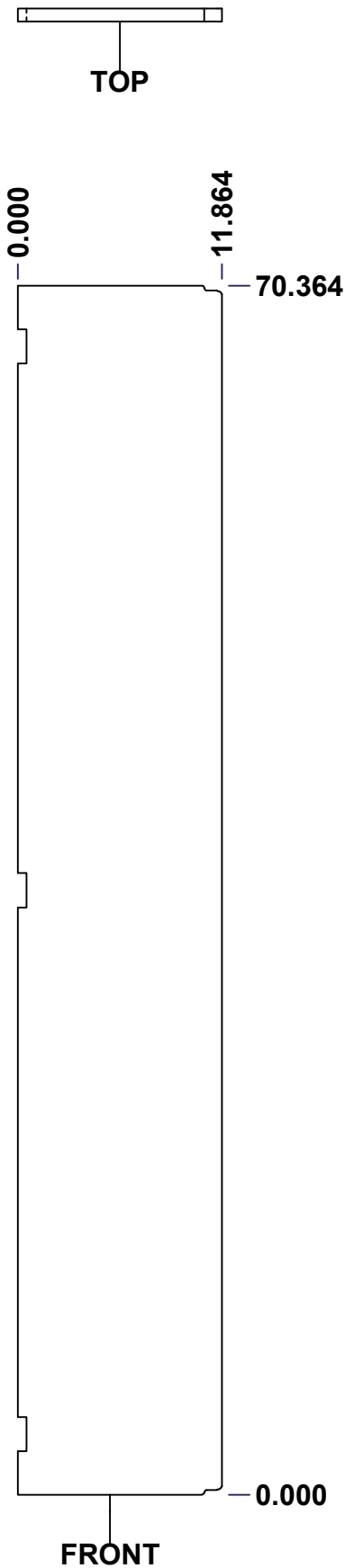

| No. | Revisions | Date | By/Par |
|-----|-----------|------|--------|
| | | | |
| | | | |
| | | | |
| | | | |
| | | | |

Isometric View

| | | | |
|---|----------|---------------------------|-----|
| <p>Tél: (450) 979-4373 Fax: (450) 979-4626 www.exmweb.com</p> | | Flatness Aplatissement | |
| | | Max 3.0mm | |
| Customer Client | | Date | |
| Drawn By Dessiné Par | | Date 23-Jan-07 | |
| Material Matière | | Polyisocyanurate | |
| Color Couleur | Aluminum | Finish Fini | N/A |
| Description | | Detail Rev. | |
| 5412ESSQT 72" x 36" Left Insulation | | | |
| Part Number Numéro Pièce | | Rev. | 12 |
| SEE BILL OF MATERIAL ON LAST PAGE 5412ESSQT7236126THI-LS | | 0 | 16 |

This drawing is confidential and must not be reproduced or used without the consent of EXM

Ce dessin est confidentiel et ne doit pas être reproduit ou utilisé sans le consentement de EXM

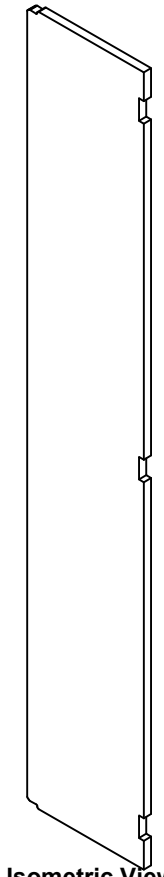
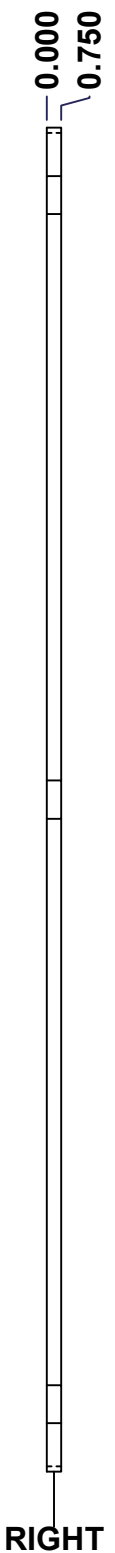
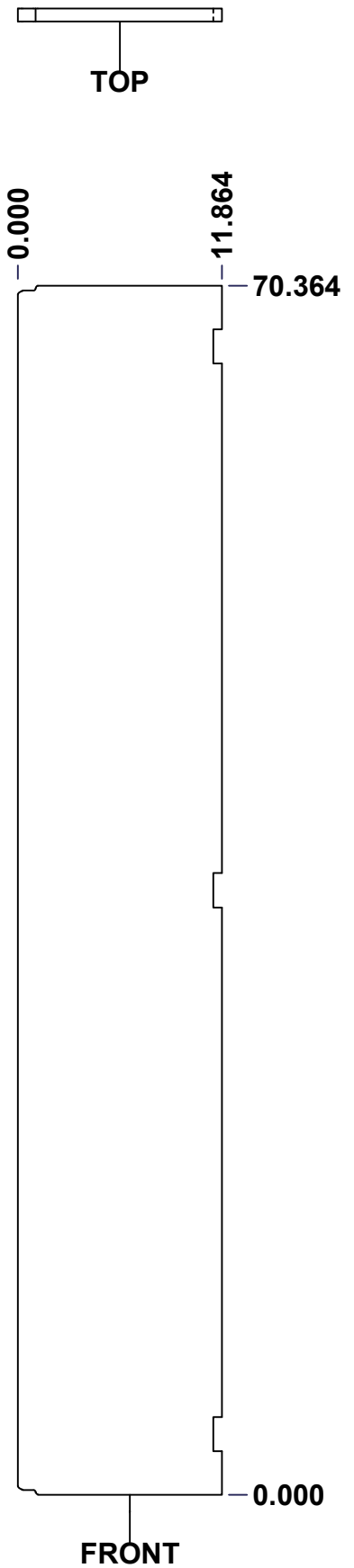

Isometric View

| No. | Revisions | Date | By/Par |
|-----|-----------|------|--------|
| | | | |
| | | | |
| | | | |
| | | | |

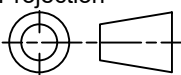

| | | |
|--|---------------------------|--|
|  Tél: (450) 979-4373 Fax: (450) 979-4626 www.exmweb.com | | Flatness Aplatissement Max 3.0mm |
| Projection  | | Date 23-Jan-07 |
| Customer Client | Date | |
| Drawn By Dessiné Par | BoxCad: Patrick Deschenes | Date 23-Jan-07 |
| Material Matière | Polyisocyanurate | |
| Color Couleur | Aluminum | Finish Fini N/A |
| Description | Detail Rev. | |
| 5412ESSQT 72" x 36" Right Insulation | | |
| Part Number Numéro Pièce | Rev. 0 | 13 / 16 |

SEE BILL OF MATERIAL ON LAST PAGE 5412ESSQT7236126THI-RS

This drawing is confidential and must not be reproduced or used without the consent of EXM

Ce dessin est confidentiel et ne doit pas être reproduit ou utilisé sans le consentement de EXM

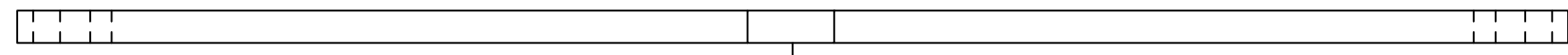

TOP

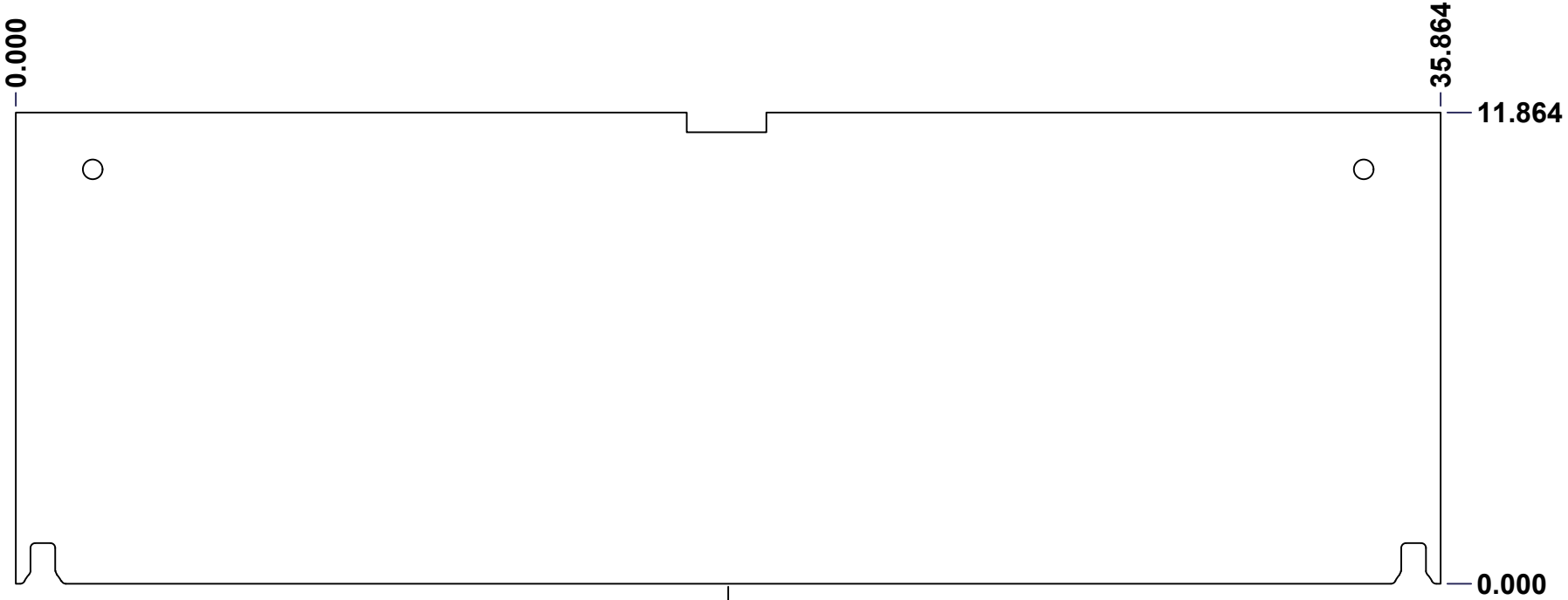

FRONT

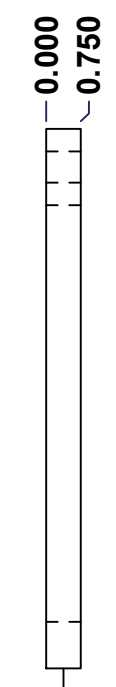

RIGHT

| No. | Revisions | Date | By/Par |
|-----|-----------|------|--------|
| | | | |
| | | | |
| | | | |
| | | | |

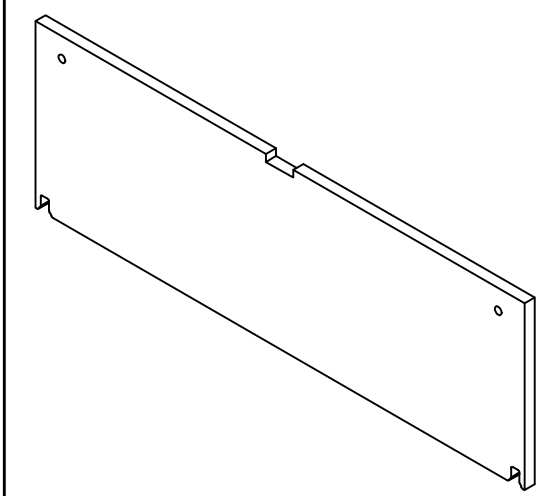
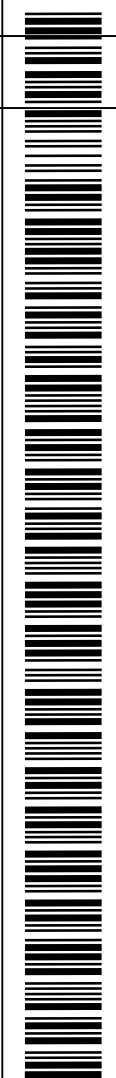

Isometric View

 Tél: (450) 979-4373
 Fax: (450) 979-4626
www.exmweb.com

Flatness / Aplatissement: Max 3.0mm
 Projection: 

| | |
|--|------------------------|
| Customer Client | Date |
| Drawn By / Dessiné Par: BoxCad: BoxCad | Date: 4/3/2024 |
| Material / Matière: Polyisocyanurate | |
| Color / Couleur: Aluminum | Finish / Fini: Brushed |
| Description: 5412ESSQT 72" x 36" Top Insulation | Detail Rev. |
| Part Number / Numéro Pièce: 5412ESSQT7236126THI-TP | Rev. 14 |
| SEE BILL OF MATERIAL ON LAST PAGE | 0 |

SEE BILL OF MATERIAL ON LAST PAGE 5412ESSQT7236126THI-TP 0 16

This drawing is confidential and must not be reproduced or used without the consent of EXM

Ce dessin est confidentiel et ne doit pas être reproduit ou utilisé sans le consentement de EXM

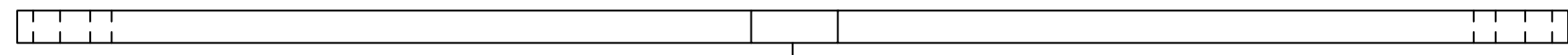

TOP

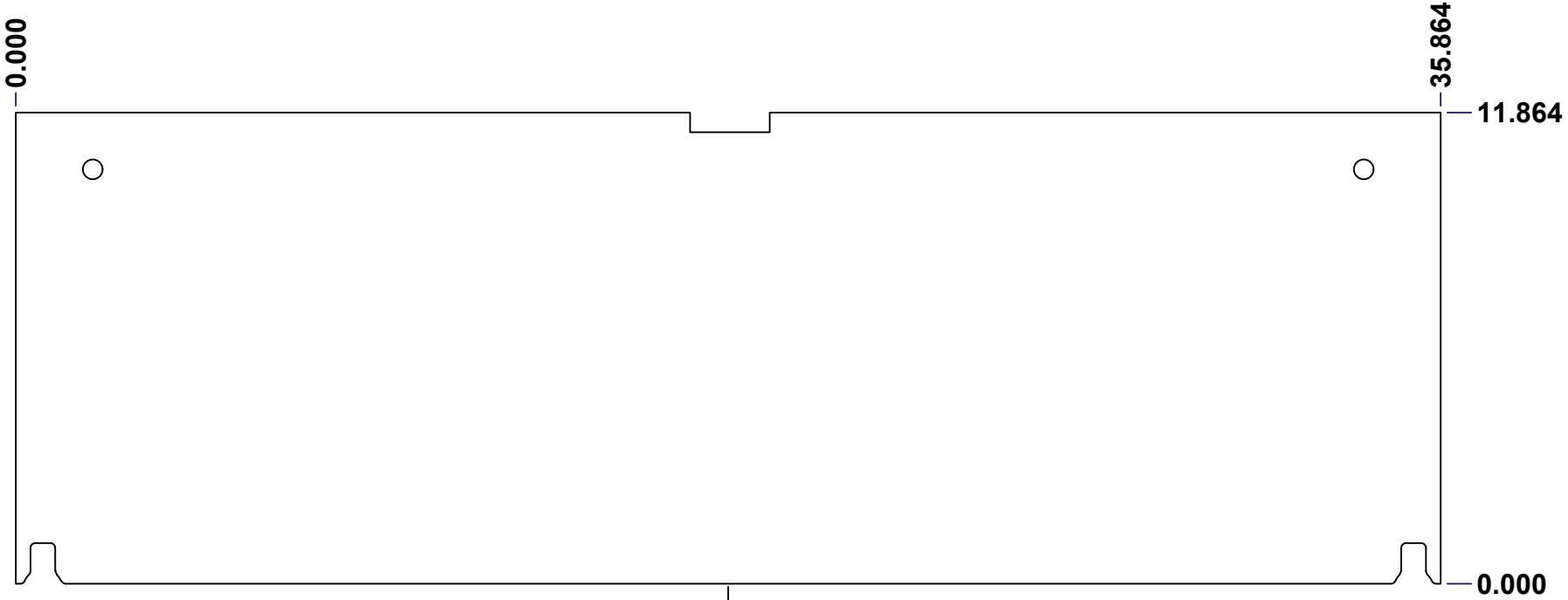

FRONT

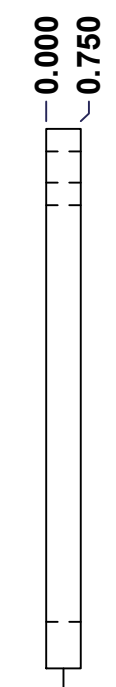

RIGHT

| No. | Revisions | Date | By/Par |
|-----|-----------|------|--------|
| | | | |
| | | | |
| | | | |
| | | | |

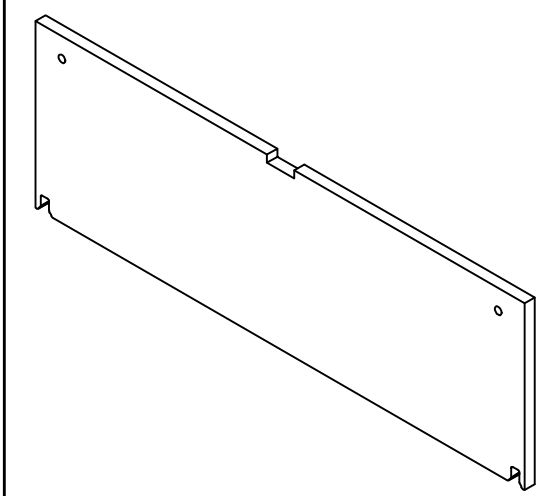
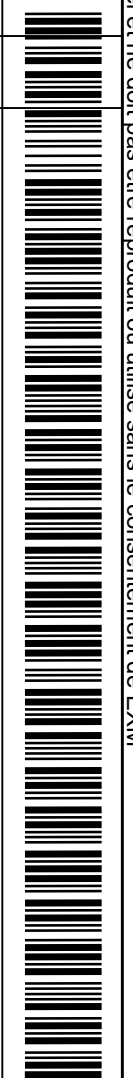

Isometric View



Tél: (450) 979-4373
 Fax: (450) 979-4626
www.exmweb.com

Flatness
Aplatissement
Max 3.0mm
Projection

| | |
|--|------------------------|
| Customer Client | Date |
| Drawn By / Dessiné Par: BoxCad: BoxCad | Date: 4/3/2024 |
| Material / Matière: Polyisocyanurate | |
| Color / Couleur: Aluminum | Finish / Fini: Brushed |
| Description: 5412ESSQT 72" x 36"Bottom Insulation | Detail Rev. |
| Part Number / Numéro Pièce: 5412ESSQT7236126THI-BT | Rev. 15 |
| SEE BILL OF MATERIAL ON LAST PAGE | 0 |

SEE BILL OF MATERIAL ON LAST PAGE 5412ESSQT7236126THI-BT 0 16

This drawing is confidential and must not be reproduced or used without the consent of EXM

Ce dessin est confidentiel et ne doit pas être reproduit ou utilisé sans le consentement de EXM

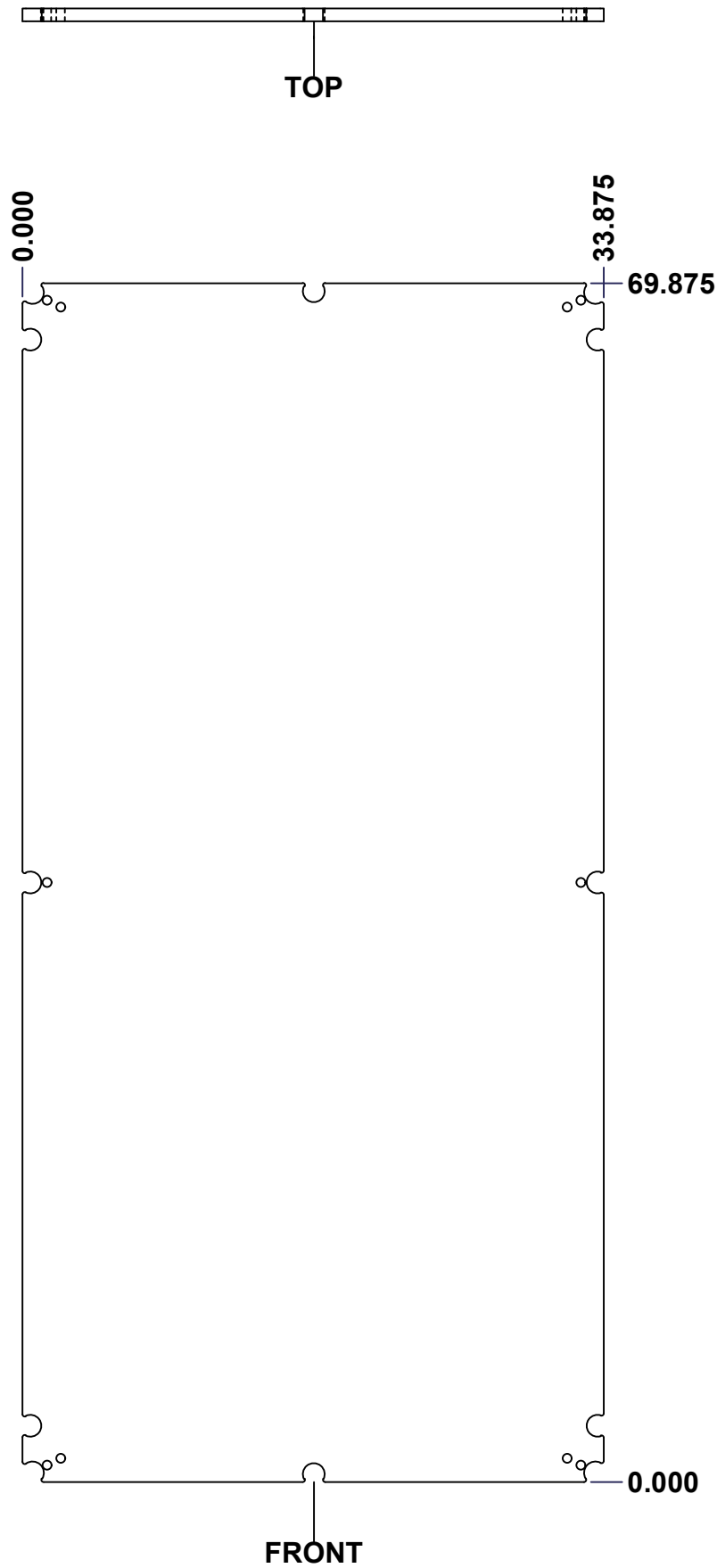

0.000
0.750

| No. | Revisions | Date | By/Par |
|-----|-----------|------|--------|
| | | | |
| | | | |
| | | | |
| | | | |

Isometric View

| | | |
|--|---------------------------|---------------------------|
| Tél: (450) 979-4373 Fax: (450) 979-4626 www.exmweb.com | | Flatness Aplatissement |
| | | Max 3.0mm |
| Projection | | Date |
| Customer Client | Date | 23-Jan-07 |
| Drawn By Dessiné Par | BoxCad: Patrick Deschenes | Date |
| Material Matière | Polyisocyanurate | |
| Color Couleur | Aluminum | Finish Fini N/A |
| Description | Detail Rev. | |
| 5412ESSQT 72" x 36" Cover Insulation | | |
| Part Number Numéro Pièce | Rev. | 16 |
| 5412ESSQT7236126THI-C | 0 | 16 |

SEE BILL OF MATERIAL ON LAST PAGE

This drawing is confidential and must not be reproduced or used without the consent of EXM

Ce dessin est confidentiel et ne doit pas être reproduit ou utilisé sans le consentement de EXM

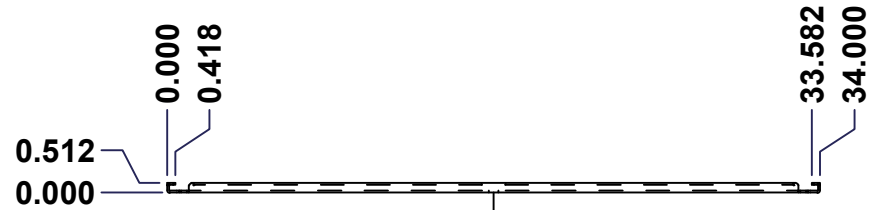

TOP

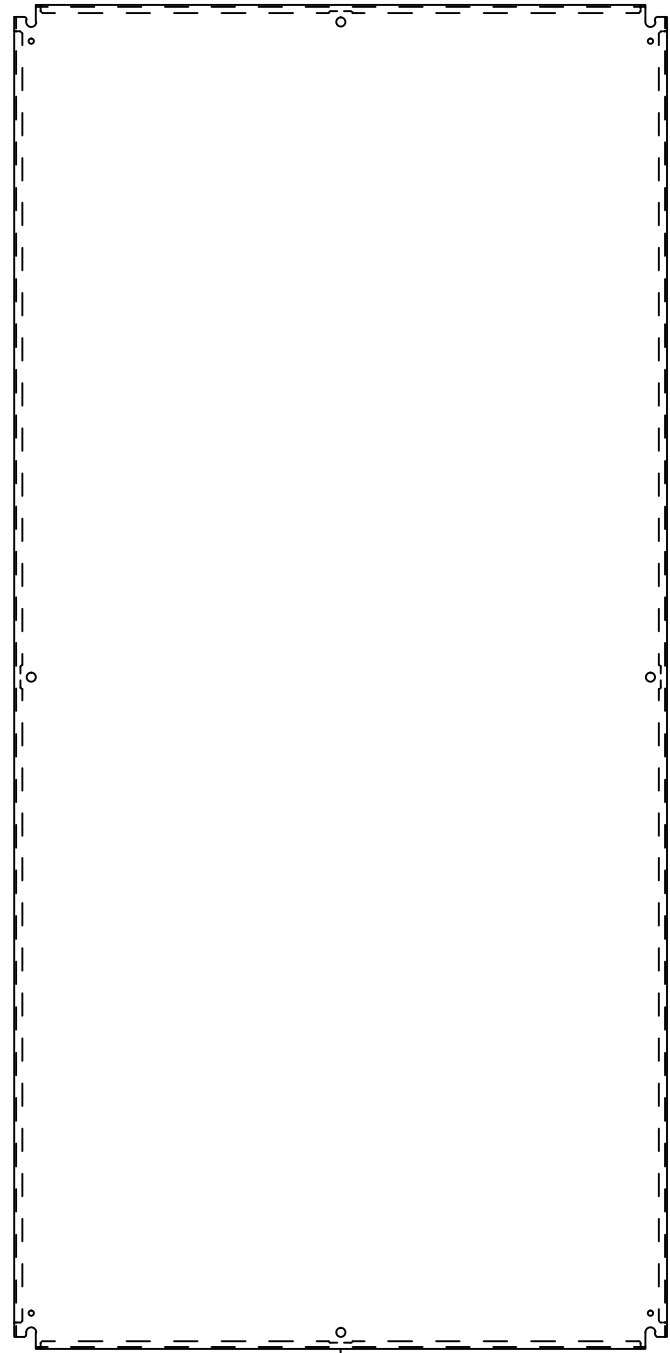

FRONT

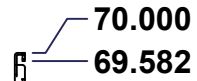

RIGHT

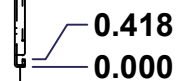

| No. | Revisions | Date | By/Par |
|-----|-----------|------|--------|
| | | | |
| | | | |
| | | | |
| | | | |
| | | | |

Isometric View

| | | |
|--|------------------------------|---------------------------|
| Tél: (450) 979-4373 Fax: (450) 979-4626 www.exmweb.com | | Flatness Aplatissement |
| | | Max 3.0mm |
| Projection | | |
| Customer Client | | Date |
| Drawn By / Dessiné Par: BoxCad | | Date: 23-Jan-07 |
| Material / Matière: See Part List | | |
| Color / Couleur: See Part List | Finish / Fini: See Part List | |
| Description: 881 SP - Inner Panel | | Detail Rev. |
| Part Number / Numéro Pièce: 881 SP7236G | | Rev. 1/2 |

| Qty | Part Number | Rev | Description | Material | Color | Finish |
|-----|---------------|-----|---------------------------|------------------|-----------|------------|
| 1 | 881 SP7236G-P | 0 | 881 SP - Inner Panel Part | 12 Ga Galvanized | Unpainted | Galvanized |

Parts List

This drawing is confidential and must not be reproduced or used without the consent of EXM

Ce dessin est confidentiel et ne doit pas être reproduit ou utilisé sans le consentement de EXM

| Table 1 | | | FRONT VIEW |
|---------|--------|--------|----------------------------|
| CUT-OUT | XDIM | YDIM | DESCRIPTION |
| 1 | 17.000 | 0.875 | MTG STUD HOLE (RND Ø0.500) |
| 2 | 0.875 | 35.000 | MTG STUD HOLE (RND Ø0.500) |
| 3 | 33.125 | 35.000 | MTG STUD HOLE (RND Ø0.500) |
| 4 | 17.000 | 69.125 | MTG STUD HOLE (RND Ø0.500) |
| 5 | 0.875 | 1.875 | GROUND HOLE (RND Ø0.290) |
| 6 | 33.125 | 1.875 | GROUND HOLE (RND Ø0.290) |
| 7 | 0.875 | 68.125 | GROUND HOLE (RND Ø0.290) |
| 8 | 33.125 | 68.125 | GROUND HOLE (RND Ø0.290) |

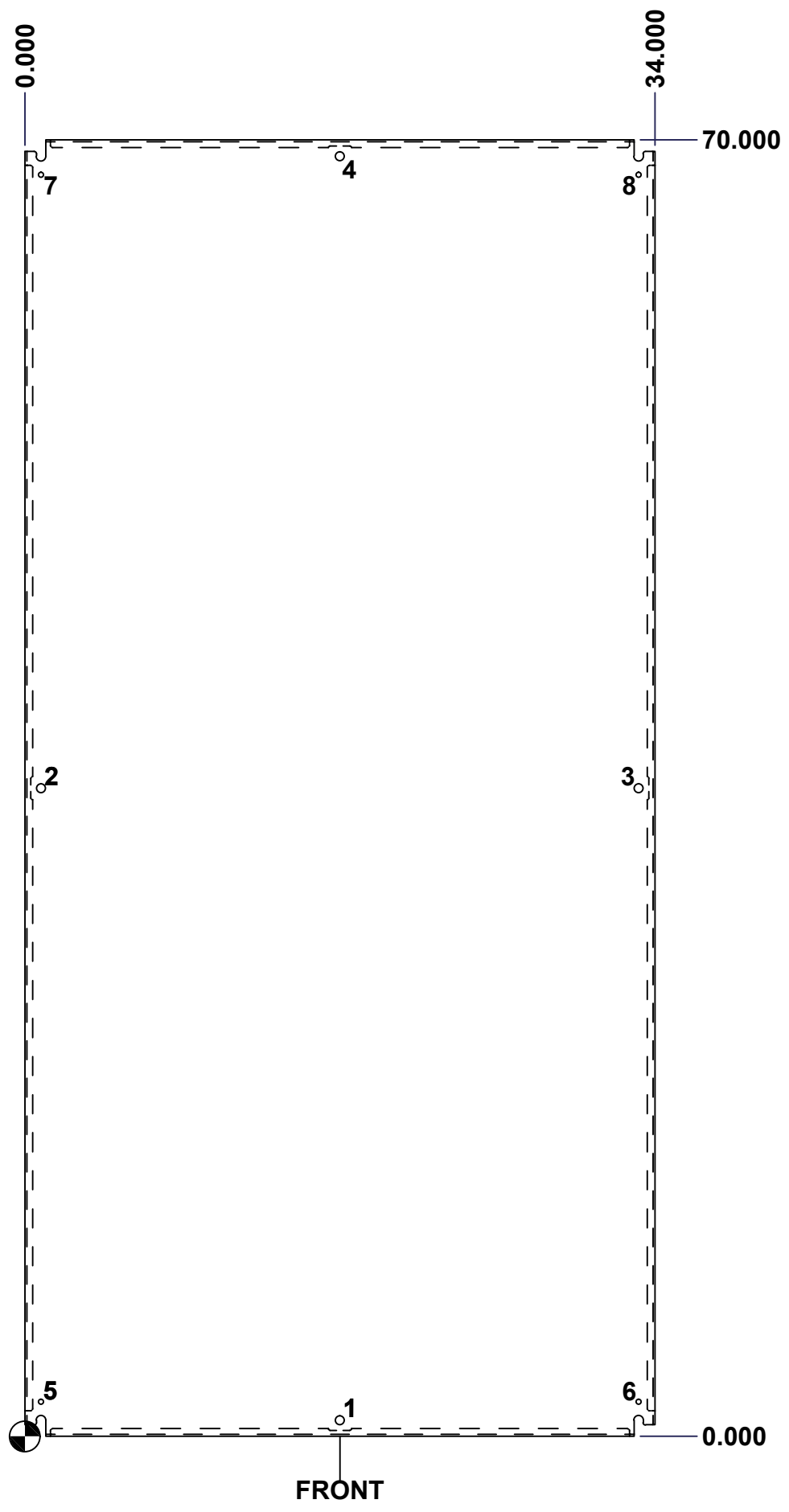

All knockouts are actual size / Les disques défonçables sont grandeur réel

| No. | Revisions | Date | By/Par |
|-----|-----------|------|--------|
| | | | |
| | | | |
| | | | |
| | | | |
| | | | |

Isometric View

| | | | | | |
|---|--|--|--|--|--|
| | | Tél: (450) 979-4373 Fax: (450) 979-4626 www.exmweb.com | | Flatness Aplatissement Max 3.0mm | |
| Customer Client | | Date | | Projection | |
| Drawn By Dessiné Par BoxCad | | Date 23-Jan-07 | | Material Matière See Part List | |
| Color Couleur See Part List | | Finish Fini See Part List | | Description 881 SP - Inner Panel | |
| Part Number Numéro Pièce 881 SP7236G | | Rev. 0 | | Detail Rev. 2 | |