

This drawing is confidential and must not be reproduced or used without the consent of EXM

Ce dessin est confidentiel et ne doit pas être reproduit ou utilisé sans le consentement de EXM

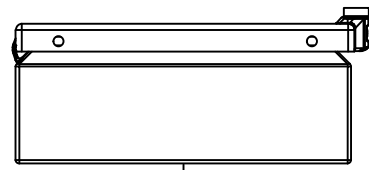

TOP

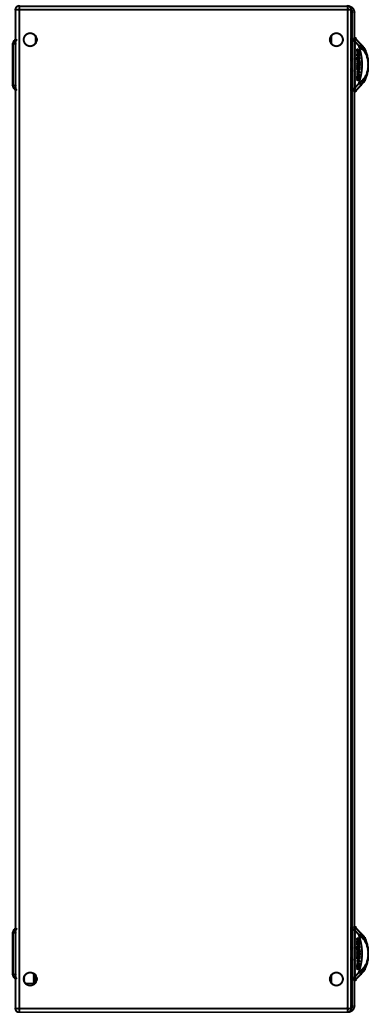

BACK

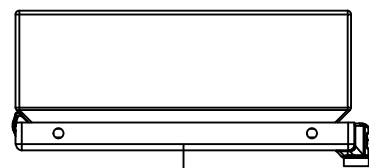

BOTTOM

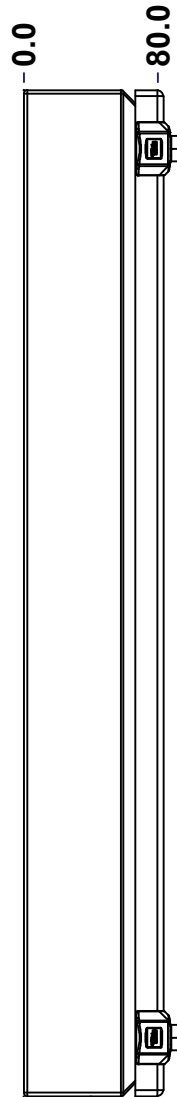

LEFT

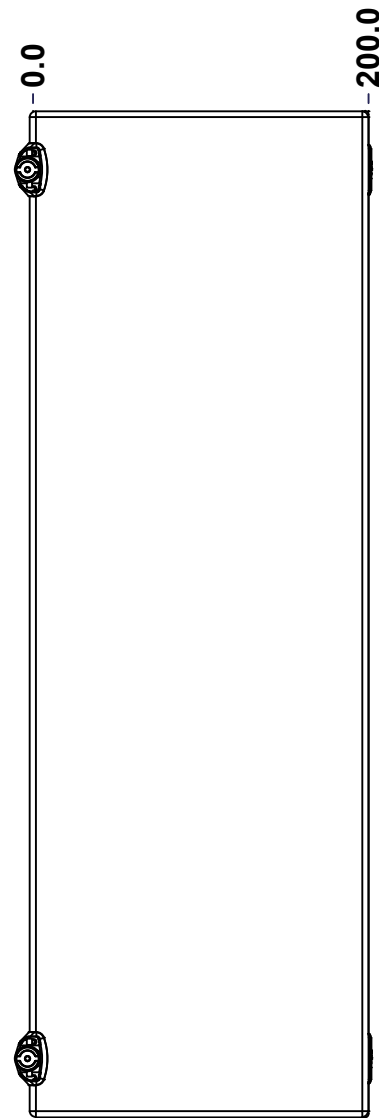

FRONT

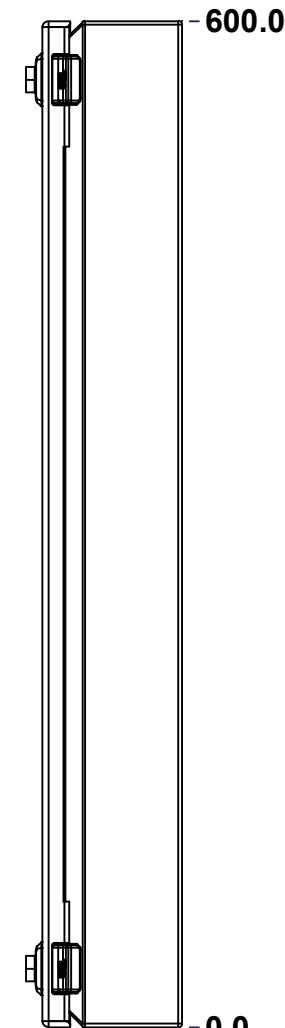

RIGHT

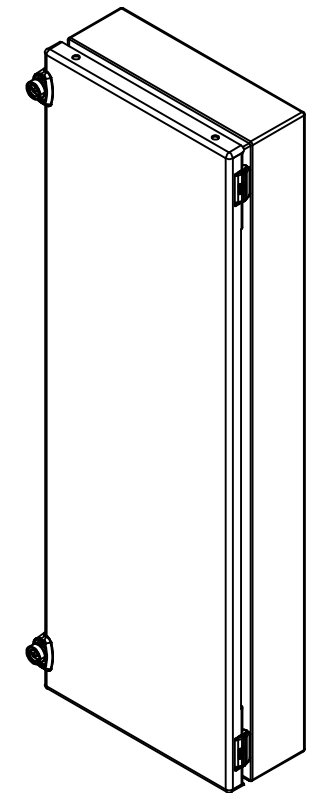

Isometric View

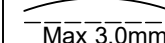
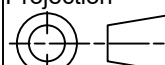

No.	Revisions	Date	By/Par

 Tél: (450) 979-4373 Fax: (450) 979-4626 www.exmweb.com		Flatness Aplatissement  Max 3.0mm Projection 
Customer Client		Date
Drawn By Dessiné Par	BoxCad: BoxCad	Date 08-Jan-25
Material Matière	16 Ga Cold Rolled A1008 CS Type B (1.4mm)	
Color Couleur	Light Grey RAL7035	Finish Fini Textured
Description 6412ESCHTB 600mm x 200mm x 80mm Assembly		Detail Rev.
Part Number Numéro Pièce	6412ESCHTB206008	Rev. 1 0

SEE BILL OF MATERIAL ON LAST PAGE

This drawing is confidential and must not be reproduced or used without the consent of EXM

Ce dessin est confidentiel et ne doit pas être reproduit ou utilisé sans le consentement de EXM

NOTE	
ITEM	DESCRIPTION
1	NEMA 4, 12 Enclosure (IP66)
2	C/W Standard ground standoffs on box and cover
3	W/O Standard door stiffener
4	W/O Inner panel
5	C/W Standard inner panel mounting standoffs

No.	Revisions	Date	By/Par

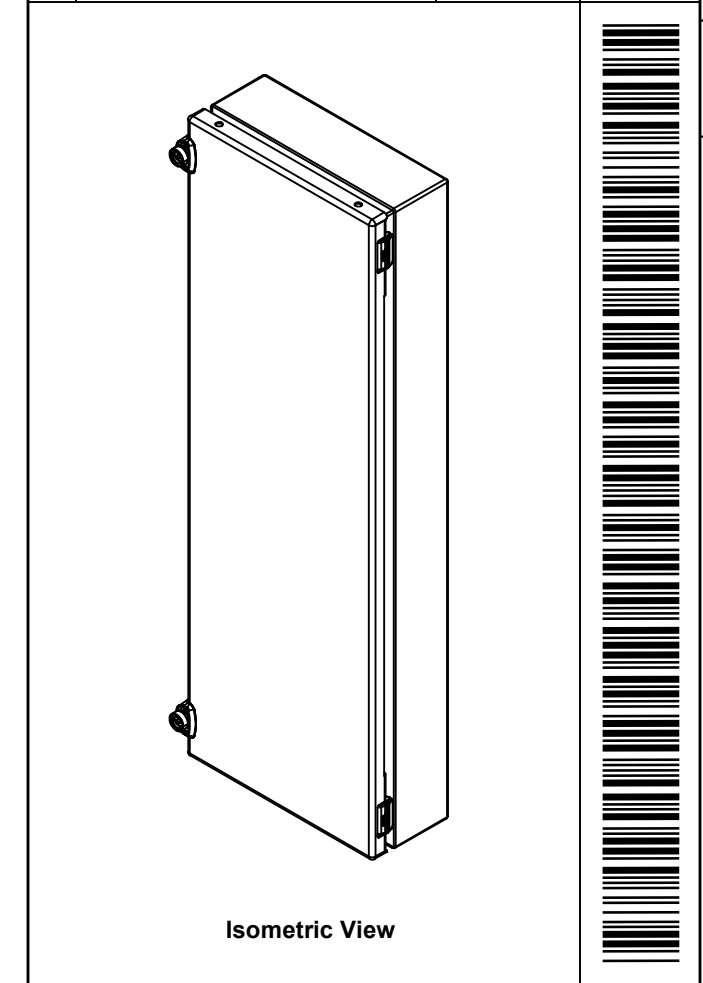

	Tél: (450) 979-4373 Fax: (450) 979-4626 www.exmweb.com	Flatness Aplatissement Max 3.0mm
		Projection
Customer Client		Date
Drawn By Dessiné Par	BoxCad: BoxCad	Date 08-Jan-25
Material Matière	16 Ga Cold Rolled A1008 CS Type B (1.4mm)	

PACKING		
ITEM	QTY	DESCRIPTION
Cardboard sleeve	2	Top and Bottom
Cardboard strip	2	Between back of enclosure and inner panel
Plastic bag	1	To protect cover surface and inside gasket
Plastic strap - Black	2	To Squeeze the 2 cardboard sleeve together
Packaging label	1	White label with product number

1	6412ESCHTB206008C	0	6412ESCHTB 600mm x 200mm Cover
2	6412ESCHTB206008BR-P	0	6412ESCHTB 200mm Bracket Part
1	STK-K-02910	3	5412 ESCH Accessory Kit
1	6412ESCHTB206008B	0	6412ESCHTB 600mm x 200mm x 80mm Body
2	STK-A-08126	0	M5 Stainless Steel 316 Nylon Insert Lock Nut with Incorporated Sealing Washer
Qty	Part Number	Rev	Description
Parts List			

Color Couleur	Light Grey RAL7035	Finish Fini	Textured
Description	6412ESCHTB 600mm x 200mm x 80mm Assembly		Detail Rev.
Part Number Numéro Pièce	6412ESCHTB206008		Rev. 2 0

This drawing is confidential and must not be reproduced or used without the consent of EXM

Ce dessin est confidentiel et ne doit pas être reproduit ou utilisé sans le consentement de EXM

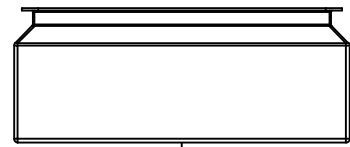

TOP

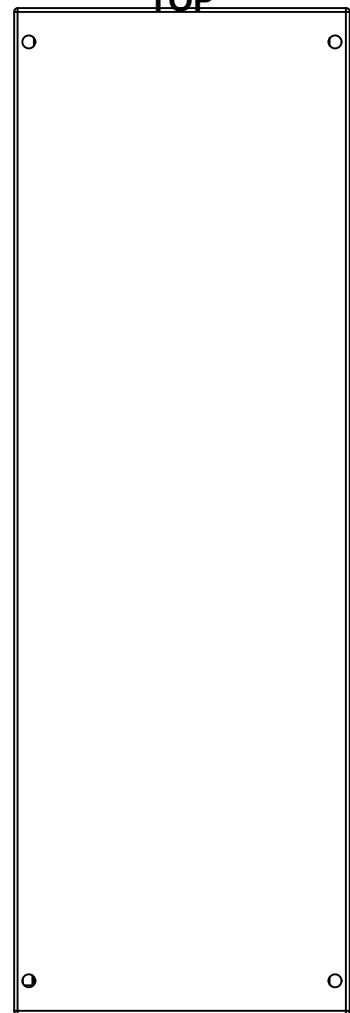

BACK

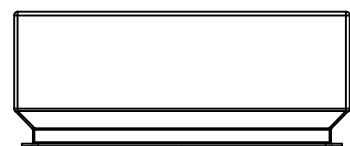

BOTTOM

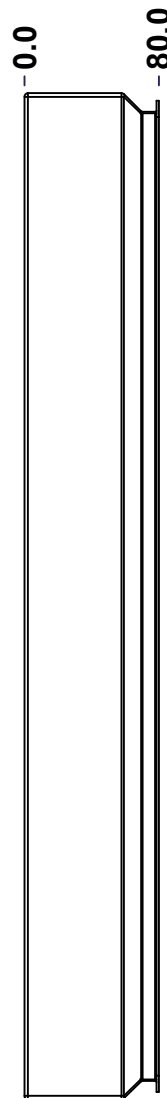

LEFT

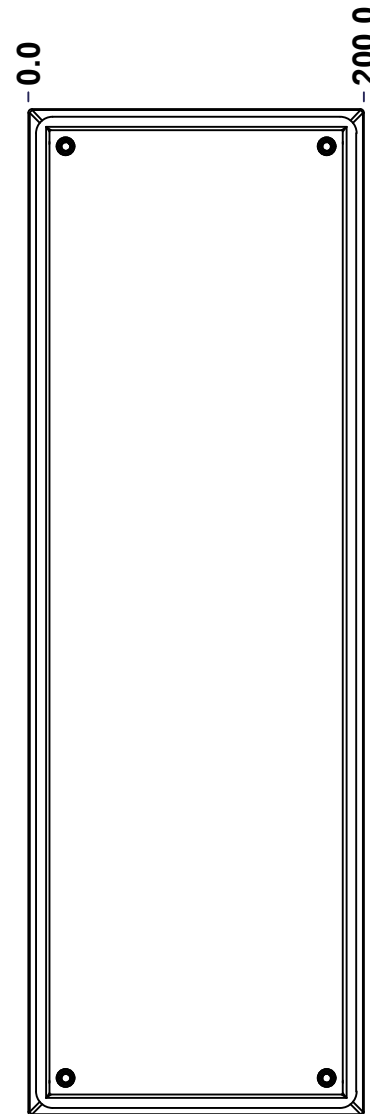

FRONT

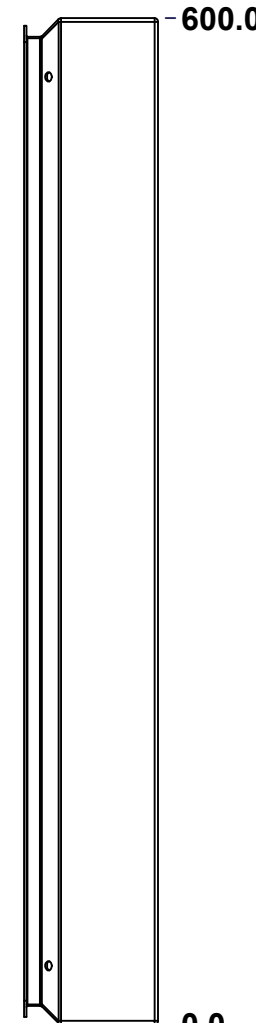

RIGHT

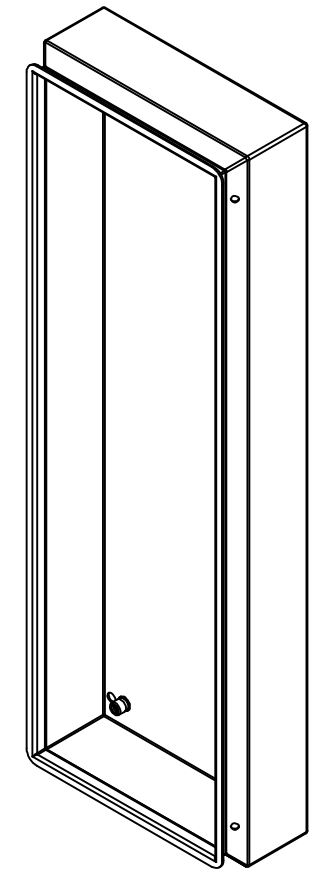

Isometric View

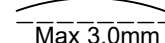

No.	Revisions	Date	By/Par

 Tél: (450) 979-4373 Fax: (450) 979-4626 www.exmweb.com		Flatness Aplatissement  Max 3.0mm
Customer Client		Date
Drawn By Dessiné Par BoxCad: BoxCad		Date 08-Jan-25
Material Matière 16 Ga Cold Rolled A1008 CS Type B (1.4mm)		
Color Couleur Light Grey RAL7035	Finish Fini Textured	
Description 6412ESCHTB 600mm x 200mm x 80mm Body		Detail Rev.
Part Number Numéro Pièce 6412ESCHTB206008B		Rev. 0 / 3

SEE BILL OF MATERIAL ON LAST PAGE

This drawing is confidential and must not be reproduced or used without the consent of EXM

Ce dessin est confidentiel et ne doit pas être reproduit ou utilisé sans le consentement de EXM

STANDARD FEATURES ARE NOT LISTED IN THIS HOLE TABLE			
HOLE TABLE - RIGHT VIEW (CUSTOM FEATURE ONLY)			
CUT-OUT	XDIM	YDIM	DESCRIPTION
1	37.2	22.2	STANDOFF M6 x 10mm (Inside)

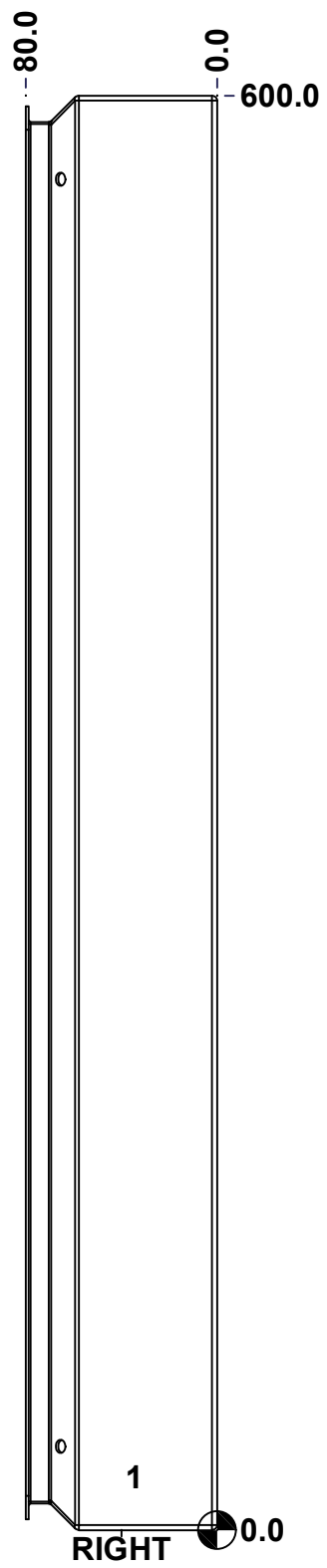

	Description 6412ESCHTB 600mm x 200mm x 72.1mm Body	Status (NULL)
	Part Number Numéro Pièce 6412ESCHTB206008B	Rev. 4 0 / 9

This drawing is confidential and must not be reproduced or used without the consent of EXM

Ce dessin est confidentiel et ne doit pas être reproduit ou utilisé sans le consentement de EXM

STANDARD FEATURES ARE NOT LISTED IN THIS HOLE TABLE

HOLE TABLE - BACK VIEW (CUSTOM FEATURE ONLY)

CUT-OUT	XDIM	YDIM	DESCRIPTION
1	22.2	22.2	IP STANDOFF M6 x 10mm (Inside)
2	22.2	577.8	IP STANDOFF M6 x 10mm (Inside)
3	177.8	577.8	IP STANDOFF M6 x 10mm (Inside)
4	177.8	22.2	IP STANDOFF M6 x 10mm (Inside)

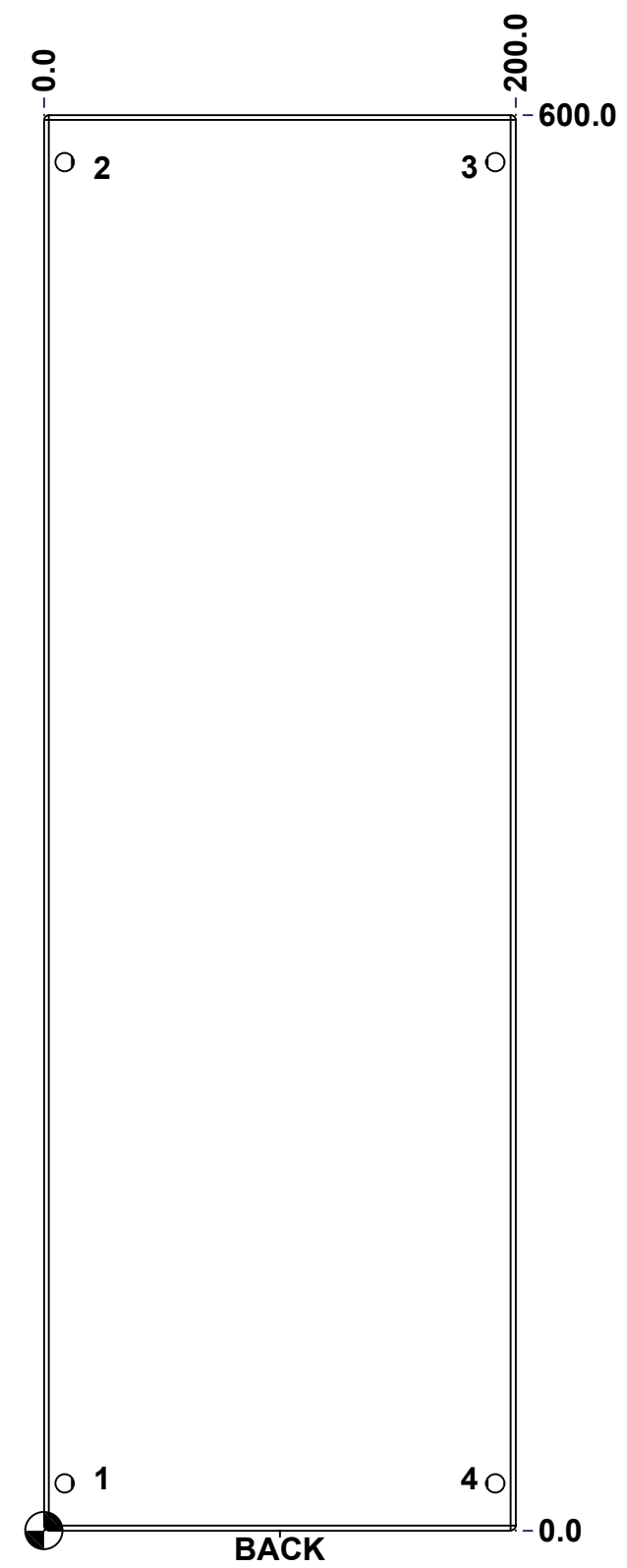



	Description 6412ESCHTB 600mm x 200mm x 72.1mm Body		Status (NULL)	
	Part Number Numéro Pièce 6412ESCHTB206008B		Rev. 0	5 9

This drawing is confidential and must not be reproduced or used without the consent of EXM

Ce dessin est confidentiel et ne doit pas être reproduit ou utilisé sans le consentement de EXM

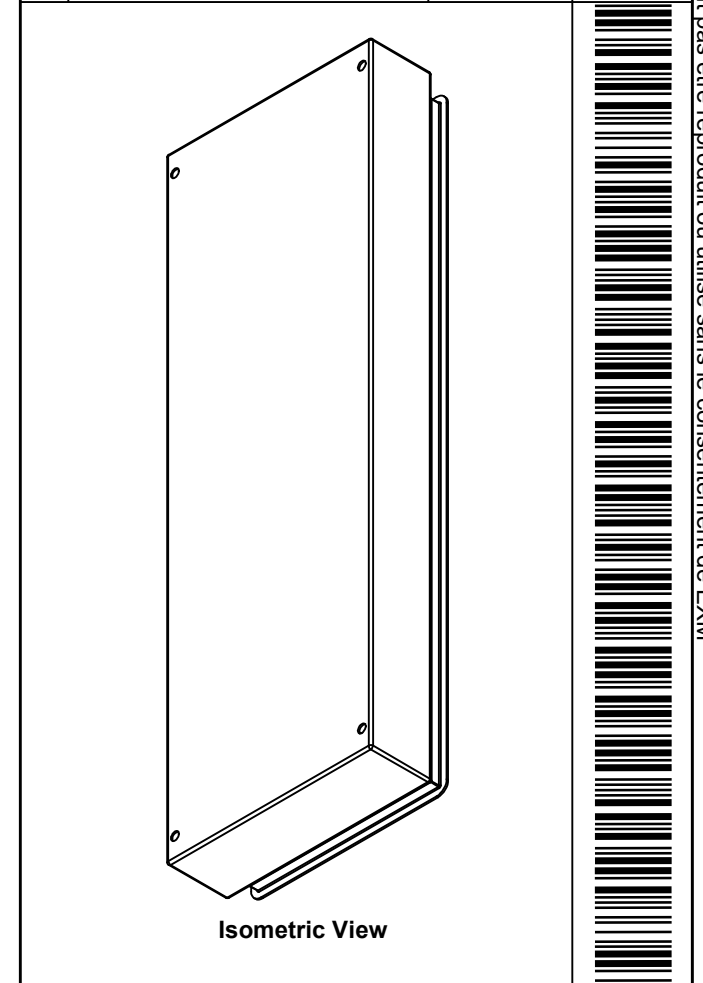
No.	Revisions	Date	By/Par

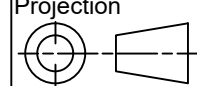

 Tél: (450) 979-4373 Fax: (450) 979-4626 www.exmweb.com		Flatness Aplatissement Max 3.0mm
Customer Client		Projection 
Drawn By Dessiné Par BoxCad: BoxCad		Date 08-Jan-25
Material Matière 16 Ga Cold Rolled A1008 CS Type B (1.4mm)		
Color Couleur Light Grey RAL7035	Finish Fini Textured	
Description 6412ESCHTB 600mm x 200mm x 80mm Body		Detail Rev.
Part Number Numéro Pièce 6412ESCHTB206008B		Rev. 6 0

Qty	Part Number	Rev	Description
1	STK-P-03820R	0	Powder Paint (Light Grey / Rough Textured)
1	6412ESCHTB206008B-P	0	6412ESCHTB 600mm x 200mm x 72.1mm Body Part
5	STK-Q-08350	5	Standoff M6 x 10mm
Parts List			

This drawing is confidential and must not be reproduced or used without the consent of EXM

Ce dessin est confidentiel et ne doit pas être reproduit ou utilisé sans le consentement de EXM

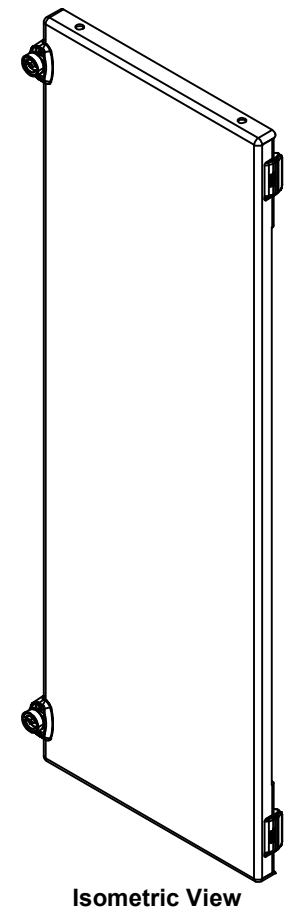
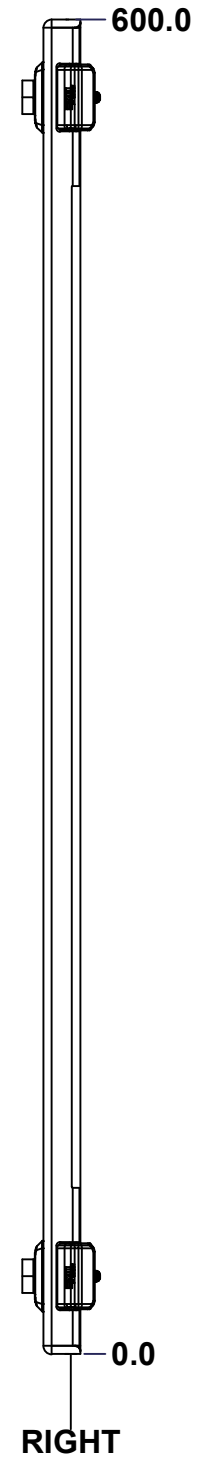
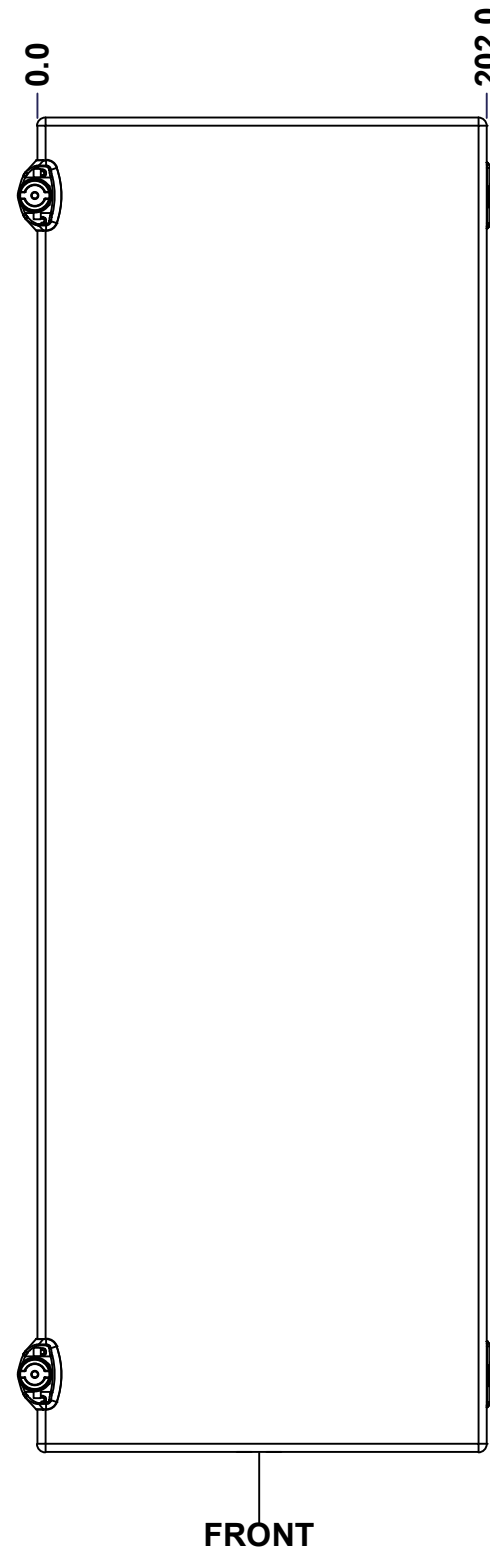
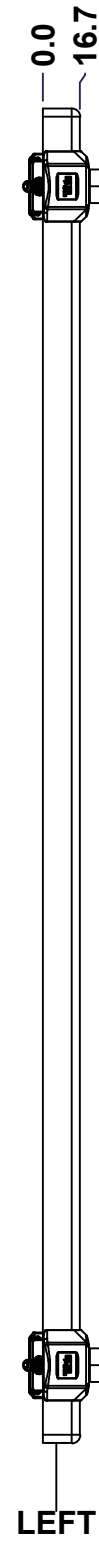
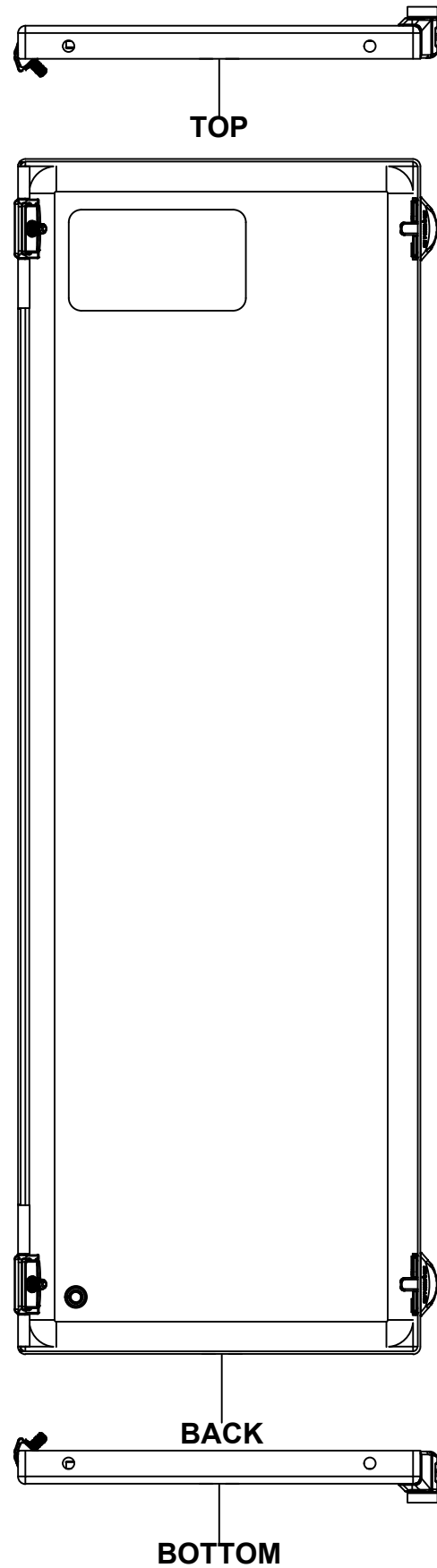

No.	Revisions	Date	By/Par

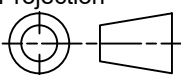
 Tél: (450) 979-4373 Fax: (450) 979-4626 www.exmweb.com		Flatness Aplatissement Max 3.0mm Projection 
Customer Client	Date	
Drawn By Dessiné Par	BoxCad: BoxCad	Date 08-Jan-25
Material Matière	16 Ga Cold Rolled A1008 CS Type B (1.4mm)	
Color Couleur	Light Grey RAL7035	Finish Fini Textured
Description	Detail Rev.	
6412ESCHTB 600mm x 200mm Cover		
Part Number Numéro Pièce	Rev.	7
6412ESCHTB206008C	0	9

SEE BILL OF MATERIAL ON LAST PAGE

This drawing is confidential and must not be reproduced or used without the consent of EXM

Ce dessin est confidentiel et ne doit pas être reproduit ou utilisé sans le consentement de EXM

STANDARD FEATURES ARE NOT LISTED IN THIS HOLE TABLE			
HOLE TABLE - FRONT VIEW (CUSTOM FEATURE ONLY)			
CUT-OUT	XDIM	YDIM	DESCRIPTION
1	29.1	28.6	STANDOFF M6 x 10mm (Inside)
2	69.9	549.2	LABEL_EXM
3	202.0	565.0	LOCK 880 SCQ2-DB @ 180.0°
4	202.0	35.0	LOCK 880 SCQ2-DB @ 180.0°

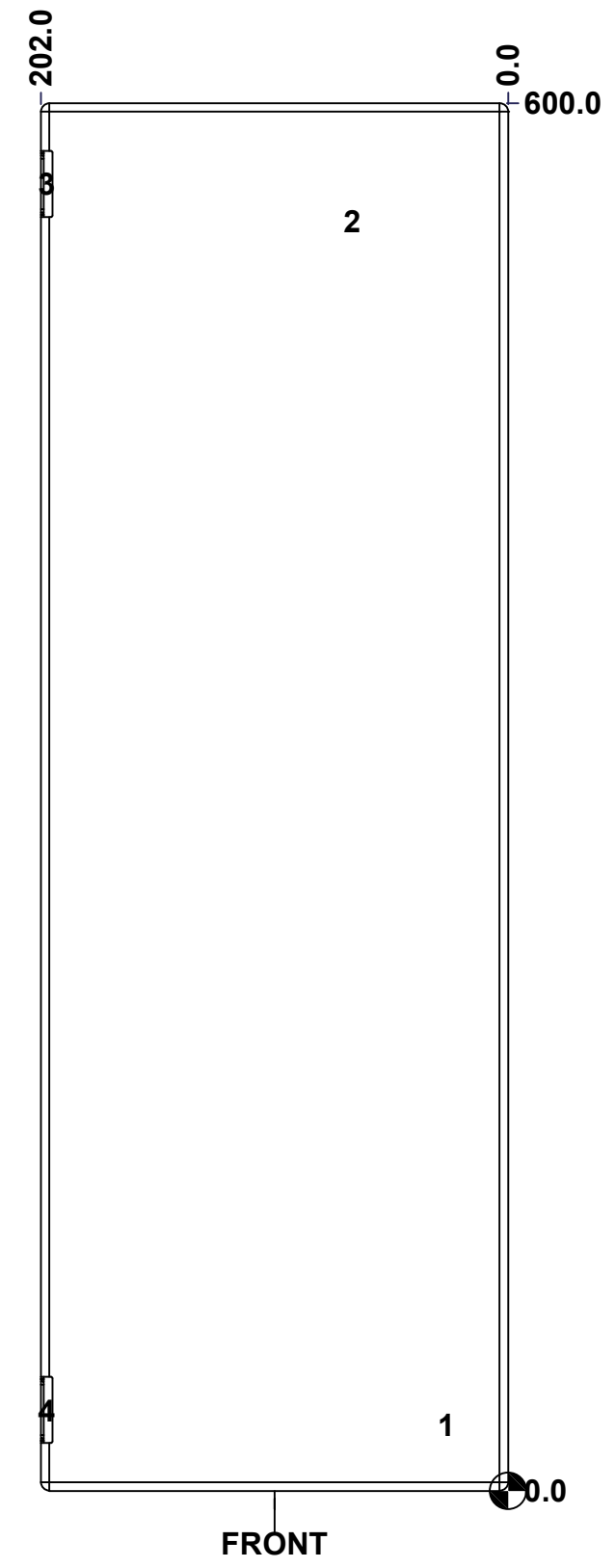

	Description	Status
	6412ESCHTB 600mm x 200mm Cover	(NULL)
	Part Number Numéro Pièce	Rev.
	6412ESCHTB206008C	0 / 8 / 9

This drawing is confidential and must not be reproduced or used without the consent of EXM

Ce dessin est confidentiel et ne doit pas être reproduit ou utilisé sans le consentement de EXM

No.	Revisions	Date	By/Par

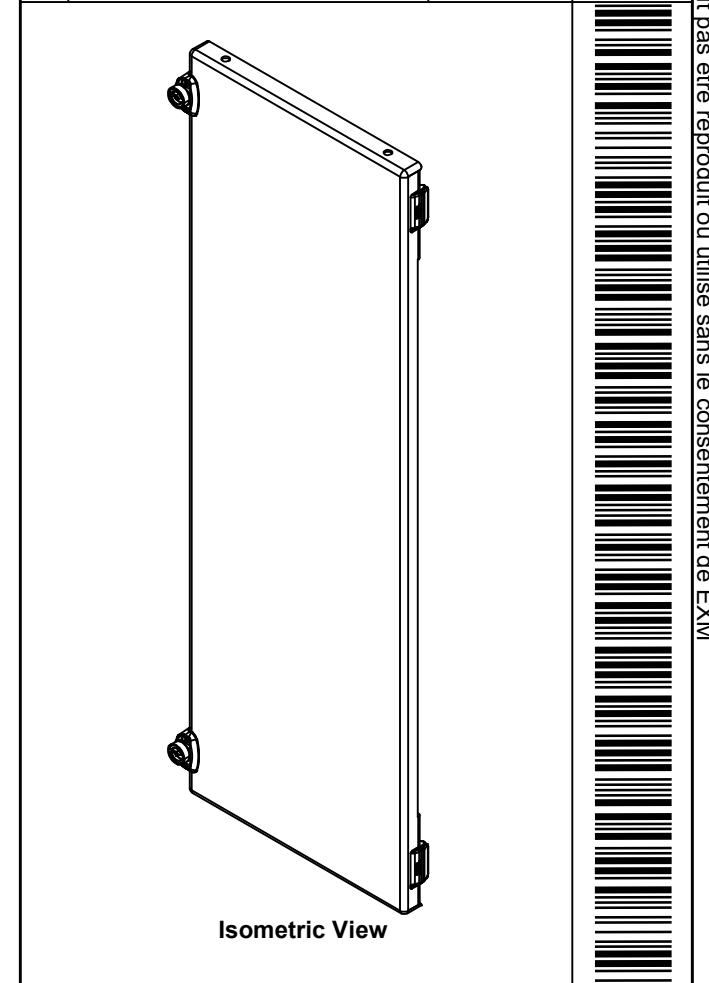

Tél: (450) 979-4373 Fax: (450) 979-4626 www.exmweb.com		Flatness Aplatissement	
		Max 3.0mm	
Customer Client		Date	
Drawn By Dessiné Par		Date	
Material Matière		Projection	
16 Ga Cold Rolled A1008 CS Type B (1.4mm)			
Color Couleur		Finish Fini	
Light Grey RAL7035		Textured	
Description			Detail Rev.
6412ESCHTB 600mm x 200mm Cover			
Part Number Numéro Pièce		Rev.	
6412ESCHTB206008C		0	9

Qty	Part Number	Rev	Description
1	STK-S-00100	0	3.5" x 2" Silver Milar Flexcon Sticker
1	STK-Q-08350	5	Standoff M6 x 10mm
1	6412ESCHTB206008G	0	6412ESCHTB 600mm x 200mm Gasket
1	STK-P-03820R	0	Powder Paint (Light Grey / Rough Textured)
1	6412ESCHTB206008C-P	0	6412ESCHTB 600mm x 200mm Cover Part
2	STK-A-33033	4	5412 ESMCH Hinge
2	STK-A-79967	4	5412 ESMCH - External Lock Assy - Double Bit Lock
Parts List			