

This drawing is confidential and must not be reproduced or used without the consent of EXM

Ce dessin est confidentiel et ne doit pas être reproduit ou utilisé sans le consentement de EXM

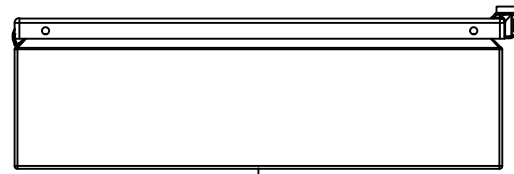

TOP

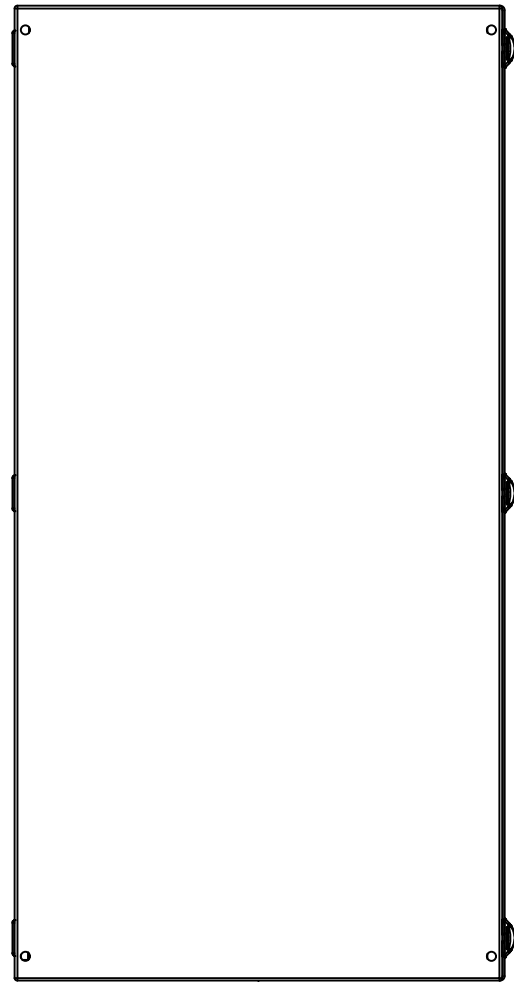

BACK

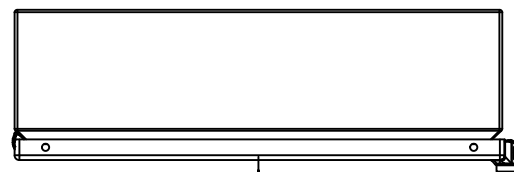

BOTTOM

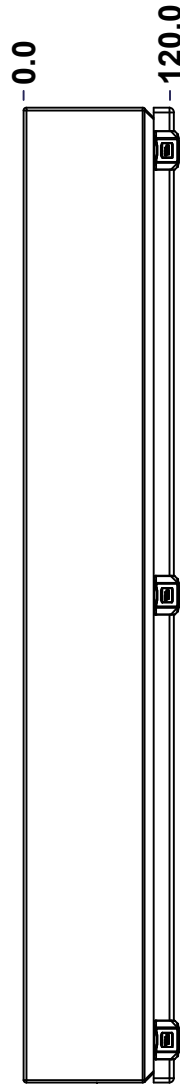

LEFT

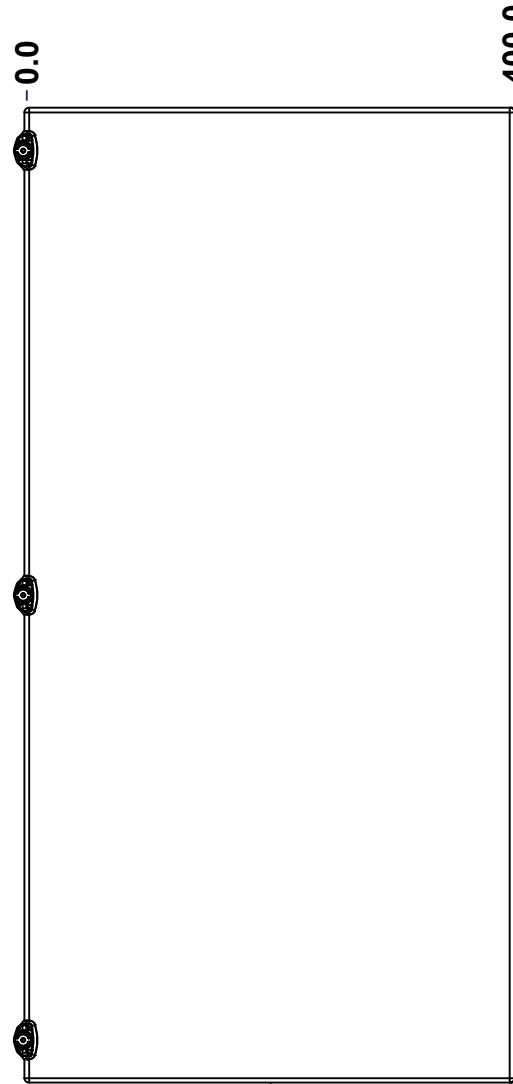

FRONT

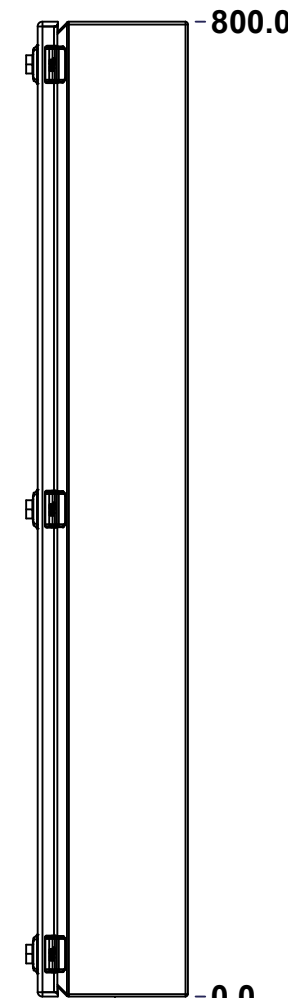

RIGHT

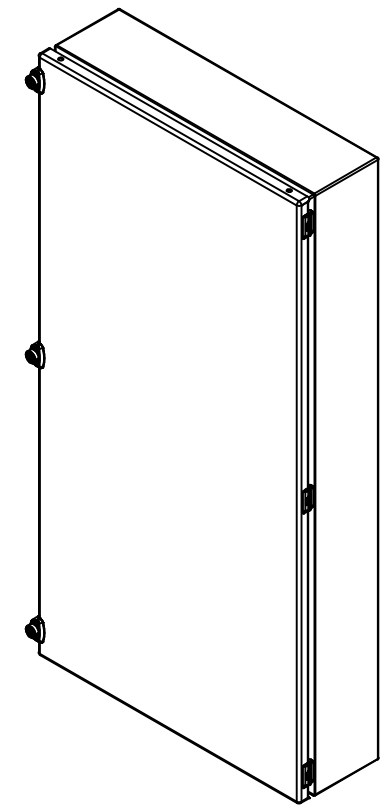

Isometric View

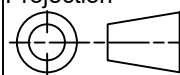

No.	Revisions	Date	By/Par

 Tél: (450) 979-4373 Fax: (450) 979-4626 <a href="http://www.exmweb.com">www.exmweb.com</a>		Flatness Aplatissement Max 3.0mm Projection 
Customer Client	Date	
Drawn By Dessiné Par	BoxCad: BoxCad	Date 07-Jan-25
Material Matière	16 Ga Cold Rolled A1008 CS Type B (1.4mm)	
Color Couleur	Light Grey RAL7035	Finish Fini Textured
Description	6412ESCHTB 800mm x 400mm x 120mm Assembly	
Part Number Numéro Pièce	6412ESCHTB408012	Detail Rev. Rev. 1 0 9

SEE BILL OF MATERIAL ON LAST PAGE

This drawing is confidential and must not be reproduced or used without the consent of EXM

Ce dessin est confidentiel et ne doit pas être reproduit ou utilisé sans le consentement de EXM

NOTE	
ITEM	DESCRIPTION
1	NEMA 4, 12 Enclosure (IP66)
2	C/W Standard ground standoffs on box and cover
3	W/O Standard door stiffener
4	W/O Inner panel
5	C/W Standard inner panel mounting standoffs

No.	Revisions	Date	By/Par

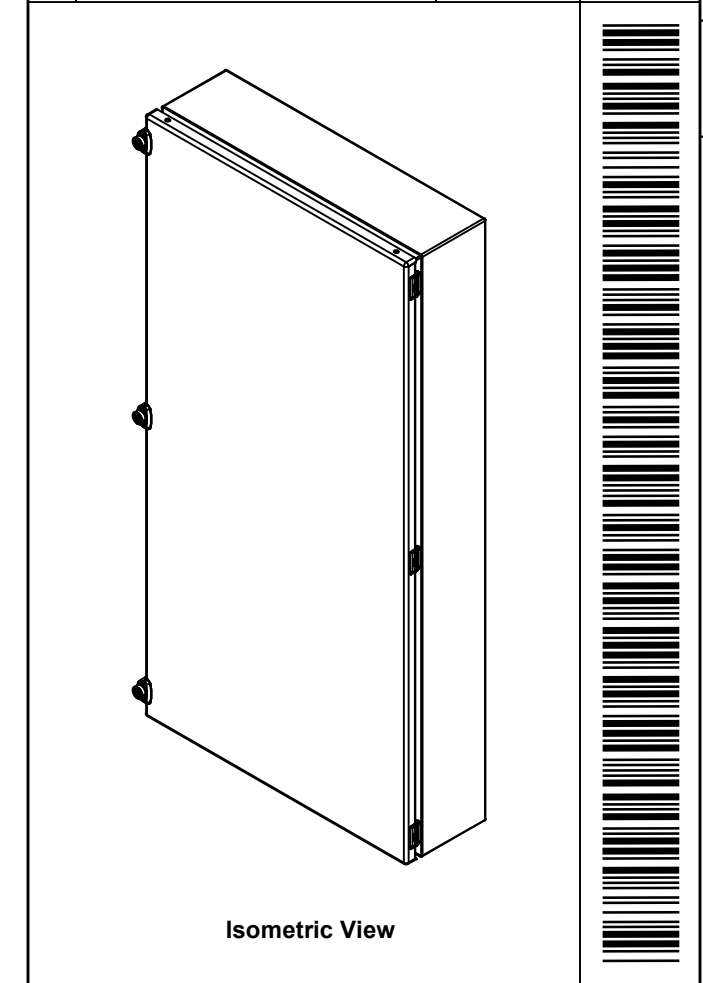

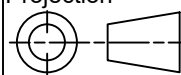
 Tél: (450) 979-4373 Fax: (450) 979-4626 <a href="http://www.exmweb.com">www.exmweb.com</a>	Flatness Aplatissement Max 3.0mm
	Projection 
Customer Client	Date
Drawn By Dessiné Par BoxCad: BoxCad	Date 07-Jan-25
Material Matière 16 Ga Cold Rolled A1008 CS Type B (1.4mm)	

PACKING		
ITEM	QTY	DESCRIPTION
Cardboard sleeve	2	Top and Bottom
Cardboard strip	2	Between back of enclosure and inner panel
Plastic bag	1	To protect cover surface and inside gasket
Plastic strap - Black	2	To Squeeze the 2 cardboard sleeve together
Packaging label	1	White label with product number

1	6412ESCHTB408012C	0	6412ESCHTB 800mm x 400mm Cover
2	6412ESCHTB408012BR-P	0	6412ESCHTB 400mm Bracket Part
1	STK-K-02910	3	5412 ESCH Accessory Kit
1	6412ESCHTB408012B	0	6412ESCHTB 800mm x 400mm x 120mm Body
3	STK-A-08126	0	M5 Stainless Steel 316 Nylon Insert Lock Nut with Incorporated Sealing Washer
Qty	Part Number	Rev	Description
Parts List			

Color Couleur Light Grey RAL7035	Finish Fini Textured
Description 6412ESCHTB 800mm x 400mm x 120mm Assembly	
Part Number Numéro Pièce <b>6412ESCHTB408012</b>	Detail Rev. Rev. 2 <b>0</b> / 9

This drawing is confidential and must not be reproduced or used without the consent of EXM

Ce dessin est confidentiel et ne doit pas être reproduit ou utilisé sans le consentement de EXM

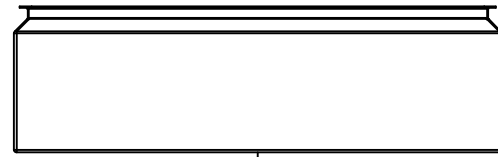

TOP



BACK



BOTTOM

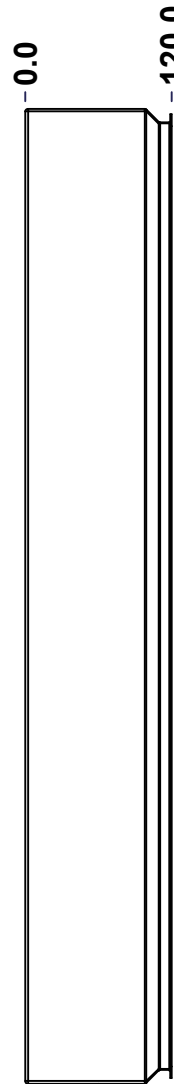

LEFT

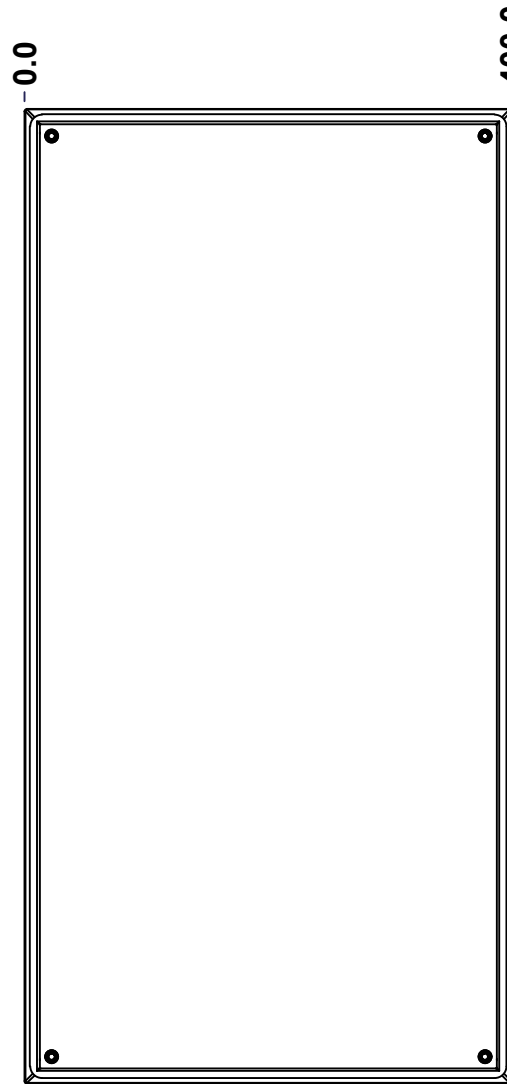

FRONT

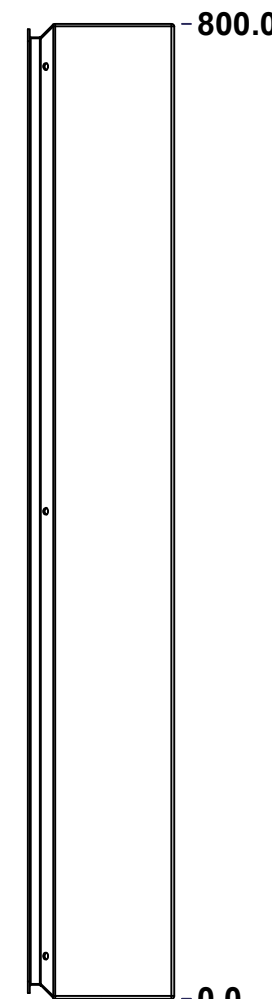

RIGHT

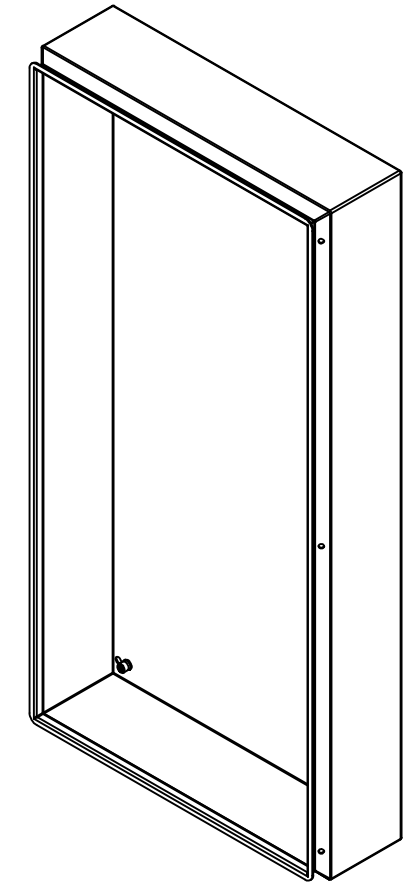

Isometric View

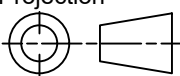

No.	Revisions	Date	By/Par

 Tél: (450) 979-4373 Fax: (450) 979-4626 <a href="http://www.exmweb.com">www.exmweb.com</a>		Flatness Aplatissement Max 3.0mm Projection 
Customer Client	Date	
Drawn By Dessiné Par	BoxCad: BoxCad	Date 07-Jan-25
Material Matière	16 Ga Cold Rolled A1008 CS Type B (1.4mm)	
Color Couleur	Light Grey RAL7035	Finish Fini Textured
Description	Detail Rev.	
6412ESCHTB 800mm x 400mm x 120mm Body		
Part Number Numéro Pièce	Rev.	3
<b>6412ESCHTB408012B</b>	<b>0</b>	9

SEE BILL OF MATERIAL ON LAST PAGE

This drawing is confidential and must not be reproduced or used without the consent of EXM

Ce dessin est confidentiel et ne doit pas être reproduit ou utilisé sans le consentement de EXM

**STANDARD FEATURES ARE NOT LISTED IN THIS HOLE TABLE**

**HOLE TABLE - RIGHT VIEW (CUSTOM FEATURE ONLY)**

CUT-OUT	XDIM	YDIM	DESCRIPTION
1	77.2	22.2	STANDOFF M6 x 10mm (Inside)

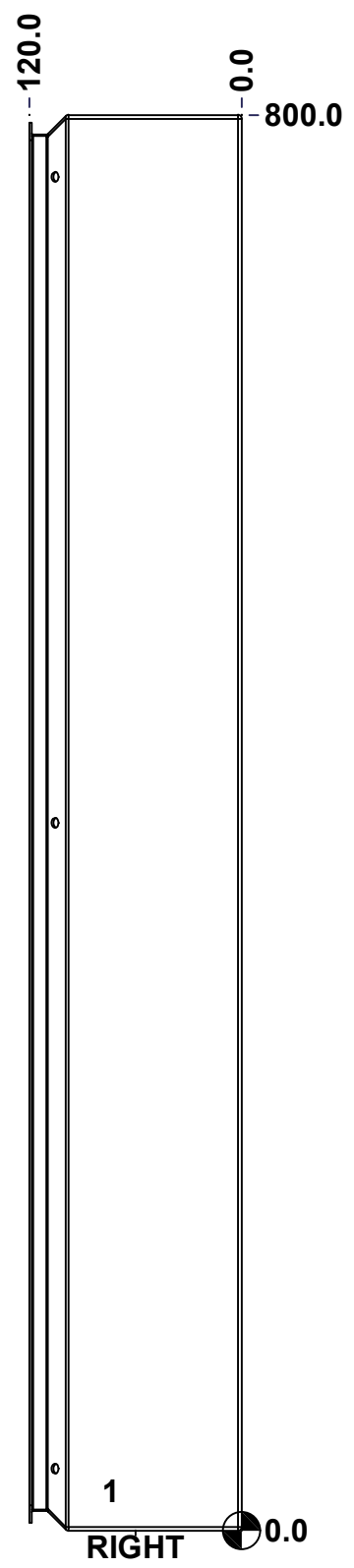

	Description 6412ESCHTB 800mm x 400mm x 112.1mm Body	Status (NULL)
	Part Number Numéro Pièce <b>6412ESCHTB408012B</b>	Rev. 4 <b>0</b> / 9

This drawing is confidential and must not be reproduced or used without the consent of EXM

Ce dessin est confidentiel et ne doit pas être reproduit ou utilisé sans le consentement de EXM

**STANDARD FEATURES ARE NOT LISTED IN THIS HOLE TABLE**

**HOLE TABLE - BACK VIEW (CUSTOM FEATURE ONLY)**

CUT-OUT	XDIM	YDIM	DESCRIPTION
1	22.2	22.2	IP STANDOFF M6 x 10mm (Inside)
2	22.2	777.8	IP STANDOFF M6 x 10mm (Inside)
3	377.8	777.8	IP STANDOFF M6 x 10mm (Inside)
4	377.8	22.2	IP STANDOFF M6 x 10mm (Inside)



	Description 6412ESCHTB 800mm x 400mm x 112.1mm Body		Status (NULL)
	Part Number Numéro Pièce <b>6412ESCHTB408012B</b>		Rev. 5 <b>0</b> / 9

This drawing is confidential and must not be reproduced or used without the consent of EXM

Ce dessin est confidentiel et ne doit pas être reproduit ou utilisé sans le consentement de EXM

No.	Revisions	Date	By/Par

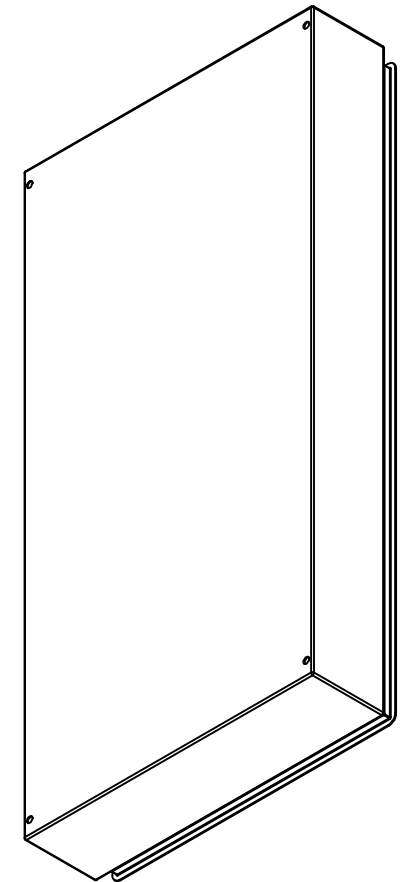

Isometric View

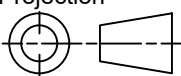

 Tél: (450) 979-4373 Fax: (450) 979-4626 <a href="http://www.exmweb.com">www.exmweb.com</a>		Flatness Aplatissement Max 3.0mm
Customer Client		Projection 
Drawn By Dessiné Par BoxCad: BoxCad		Date 07-Jan-25
Material Matière 16 Ga Cold Rolled A1008 CS Type B (1.4mm)		
Color Couleur Light Grey RAL7035	Finish Fini Textured	
Description 6412ESCHTB 800mm x 400mm x 120mm Body		Detail Rev.
Part Number Numéro Pièce <b>6412ESCHTB408012B</b>		Rev. 6 <b>0</b>

Qty	Part Number	Rev	Description
1	STK-P-03820R	0	Powder Paint (Light Grey / Rough Textured)
1	6412ESCHTB408012B-P	0	6412ESCHTB 800mm x 400mm x 112.1mm Body Part
5	STK-Q-08350	5	Standoff M6 x 10mm
Parts List			

This drawing is confidential and must not be reproduced or used without the consent of EXM

Ce dessin est confidentiel et ne doit pas être reproduit ou utilisé sans le consentement de EXM

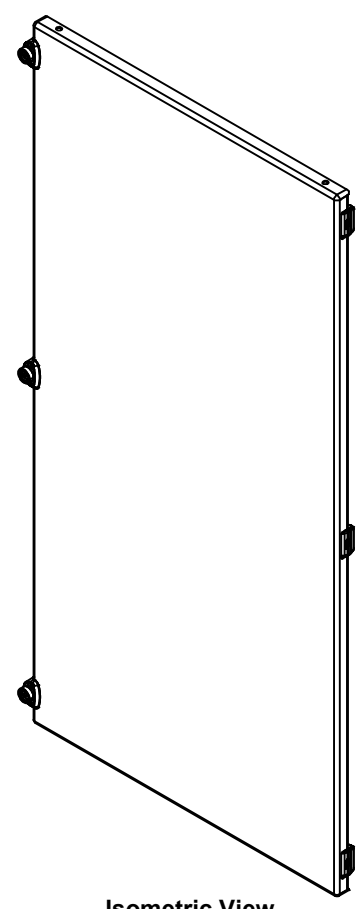
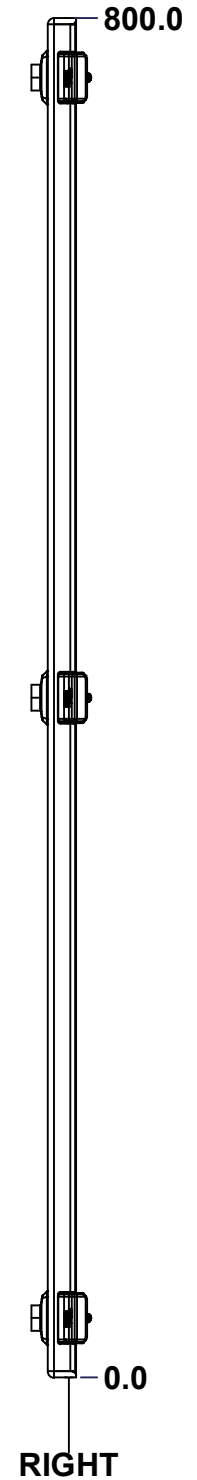
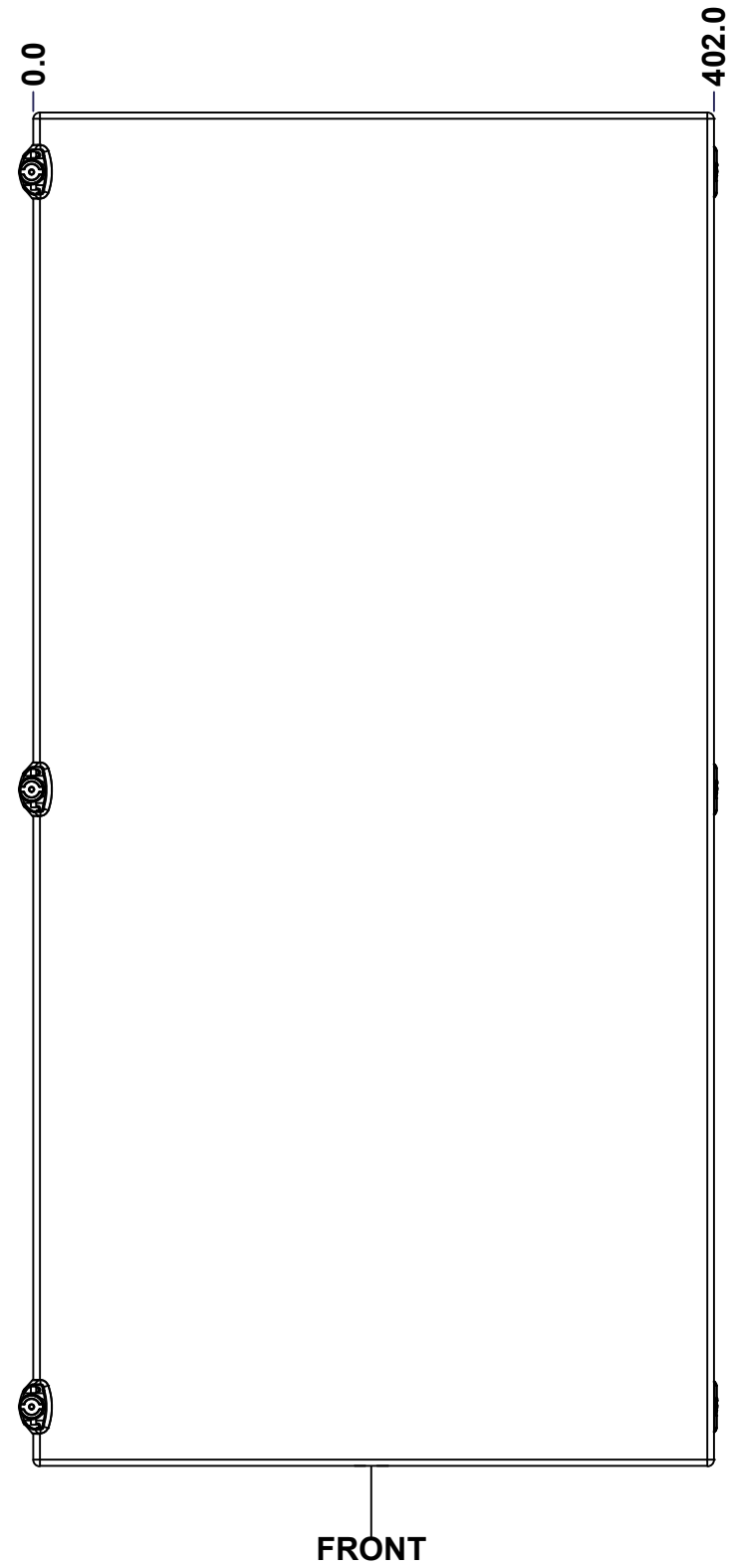
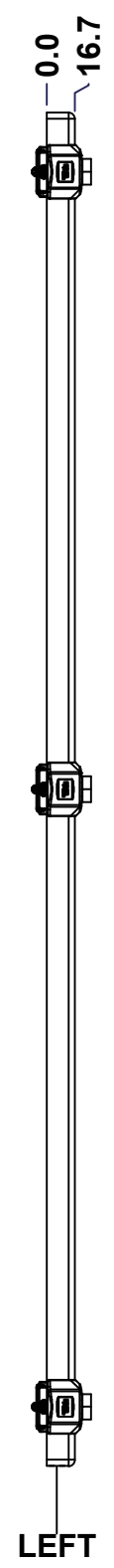
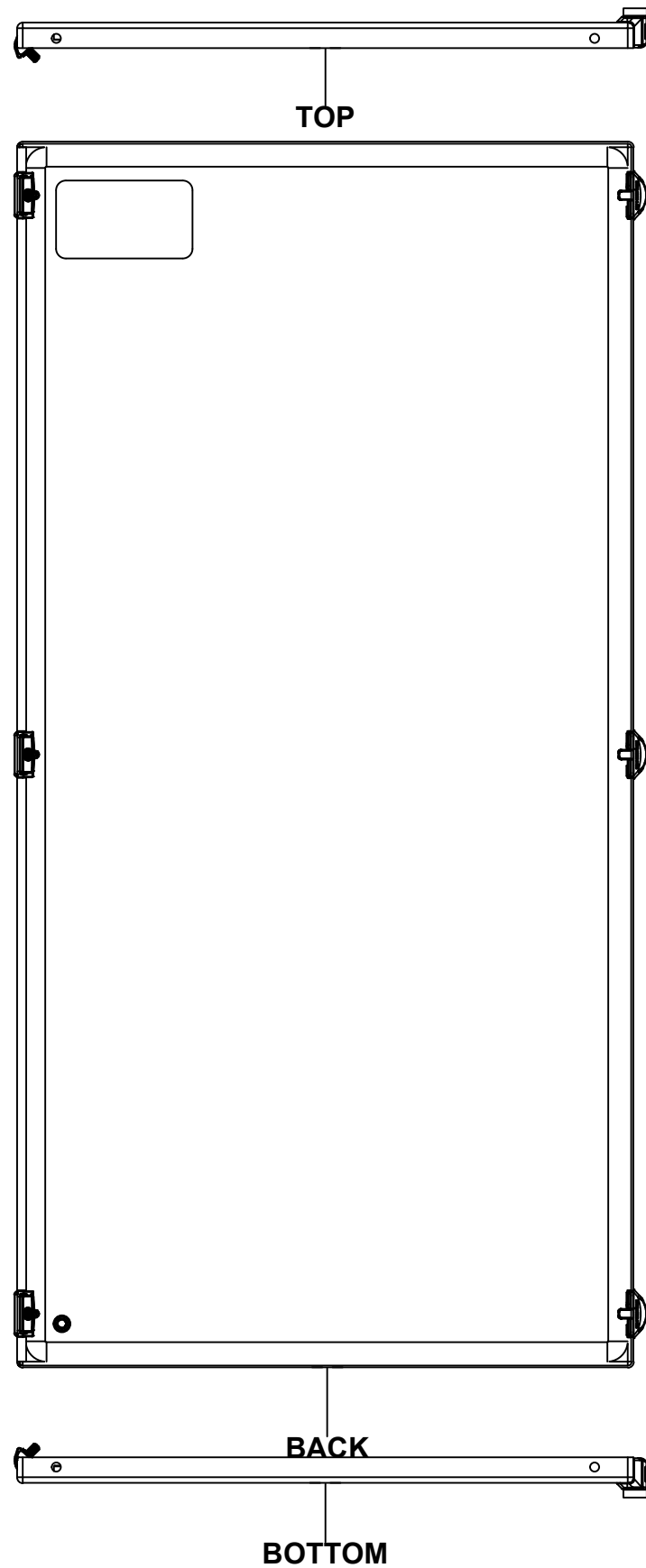

Isometric View



No.	Revisions	Date	By/Par

		Flatness Aplatissement Max 3.0mm Projection 	
Customer Client		Date	
Drawn By Dessiné Par BoxCad: BoxCad		Date 07-Jan-25	
Material Matière 16 Ga Cold Rolled A1008 CS Type B (1.4mm)			
Color Couleur Light Grey RAL7035		Finish Fini Textured	
Description 6412ESCHTB 800mm x 400mm Cover			Detail Rev.
Part Number Numéro Pièce <b>6412ESCHTB408012C</b>		Rev. <b>0</b>	7 9

SEE BILL OF MATERIAL ON LAST PAGE

This drawing is confidential and must not be reproduced or used without the consent of EXM

Ce dessin est confidentiel et ne doit pas être reproduit ou utilisé sans le consentement de EXM

**STANDARD FEATURES ARE NOT LISTED IN THIS HOLE TABLE**

**HOLE TABLE - FRONT VIEW (CUSTOM FEATURE ONLY)**

CUT-OUT	XDIM	YDIM	DESCRIPTION
1	29.1	28.6	STANDOFF M6 x 10mm (Inside)
2	69.9	749.2	LABEL_EXM
3	402.0	765.0	LOCK 880 SCQ2-DB @ 180.0°
4	402.0	400.0	LOCK 880 SCQ2-DB @ 180.0°
5	402.0	35.0	LOCK 880 SCQ2-DB @ 180.0°

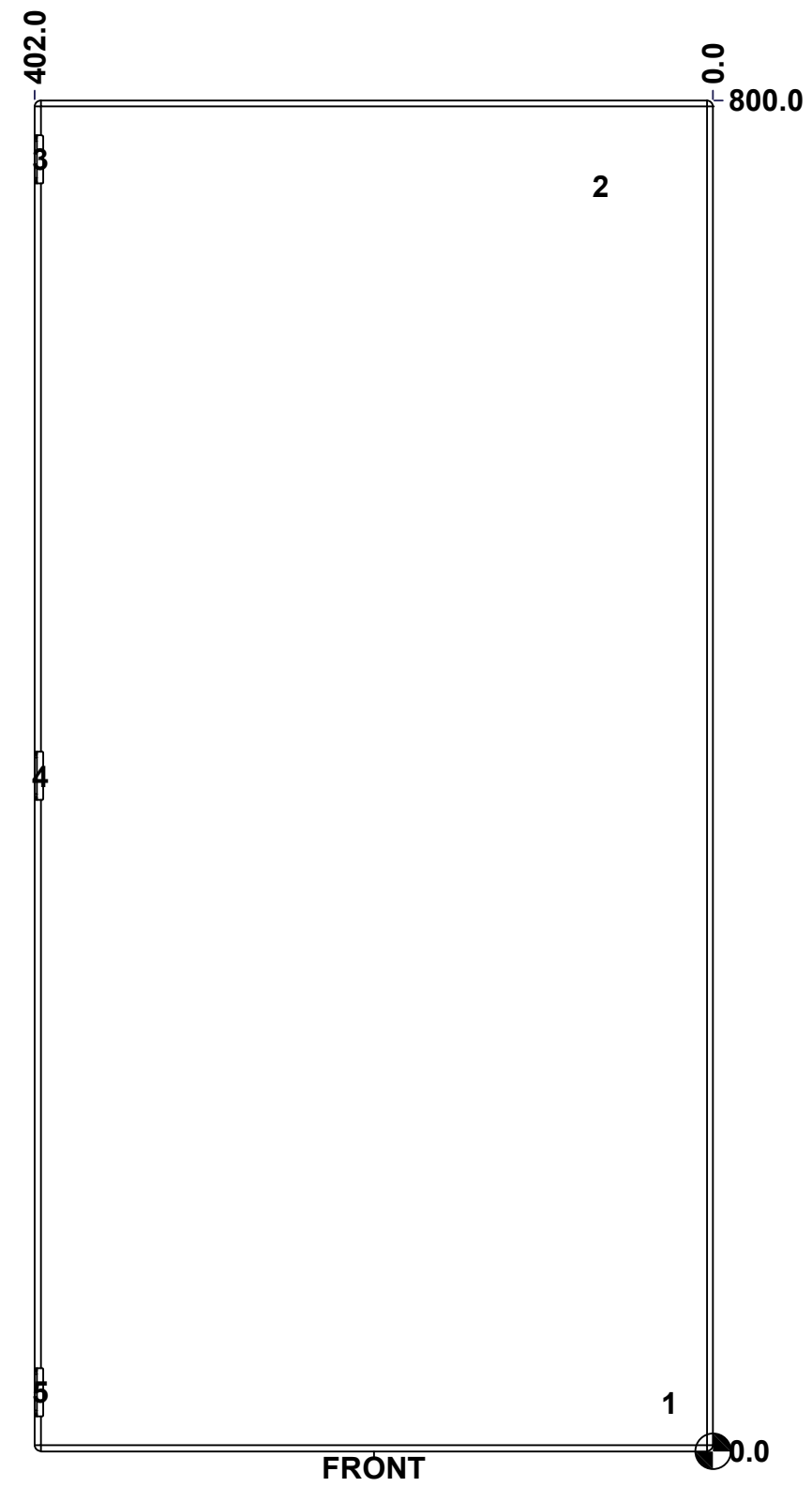



	Description	Status
	6412ESCHTB 800mm x 400mm Cover	(NULL)
	Part Number Numéro Pièce	Rev.
	<b>6412ESCHTB408012C</b>	<b>0</b> / 8 / 9

This drawing is confidential and must not be reproduced or used without the consent of EXM

Ce dessin est confidentiel et ne doit pas être reproduit ou utilisé sans le consentement de EXM

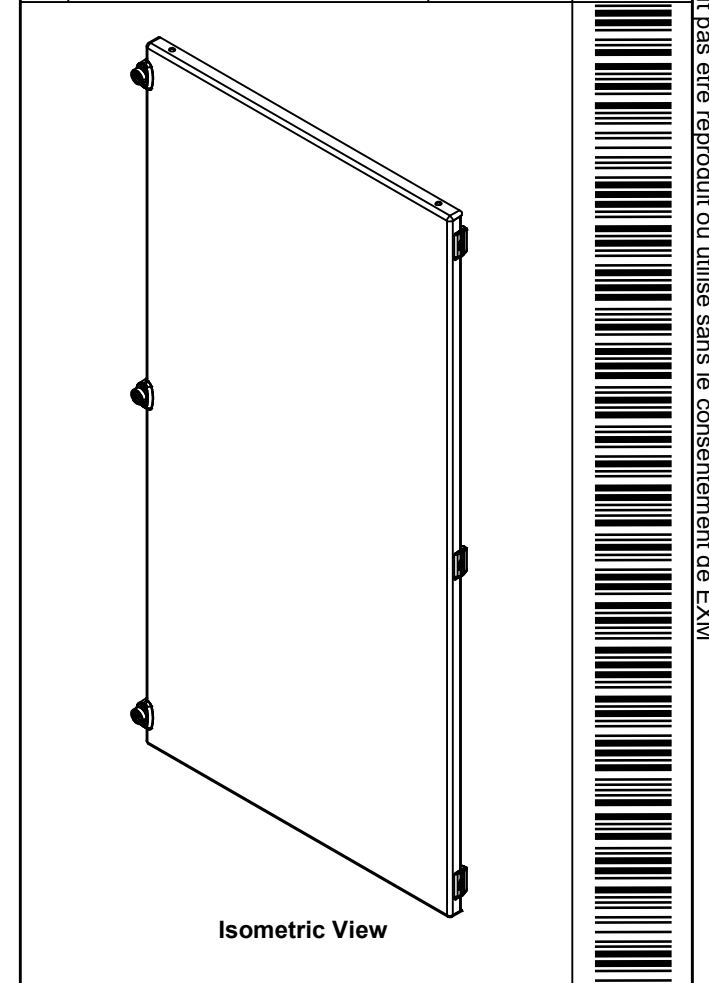
No.	Revisions	Date	By/Par

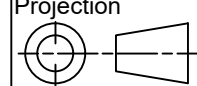

 Tél: (450) 979-4373 Fax: (450) 979-4626 <a href="http://www.exmweb.com">www.exmweb.com</a>		Flatness Aplatissement Max 3.0mm
Customer Client		Projection 
Drawn By / Dessiné Par: BoxCad: BoxCad		Date: 07-Jan-25
Material / Matière: 16 Ga Cold Rolled A1008 CS Type B (1.4mm)		
Color / Couleur: Light Grey RAL7035	Finish / Fini: Textured	
Description: 6412ESCHTB 800mm x 400mm Cover		Detail Rev.
Part Number / Numéro Pièce: <b>6412ESCHTB408012C</b>		Rev. 9 <b>0</b>

Qty	Part Number	Rev	Description
1	STK-S-00100	0	3.5" x 2" Silver Milar Flexcon Sticker
1	STK-Q-08350	5	Standoff M6 x 10mm
1	STK-P-03820R	0	Powder Paint (Light Grey / Rough Textured)
1	6412ESCHTB408012G	0	6412ESCHTB 800mm x 400mm Gasket
1	6412ESCHTB408012C-P	0	6412ESCHTB 800mm x 400mm Cover Part
3	STK-A-33033	4	5412 ESMCH Hinge
3	STK-A-79967	4	5412 ESMCH - External Lock Assy - Double Bit Lock
Parts List			