

This drawing is confidential and must not be reproduced or used without the consent of EXM

Ce dessin est confidentiel et ne doit pas être reproduit ou utilisé sans le consentement de EXM

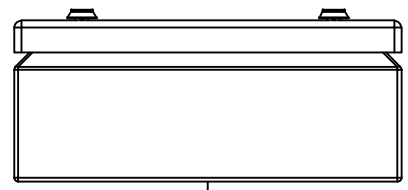

TOP

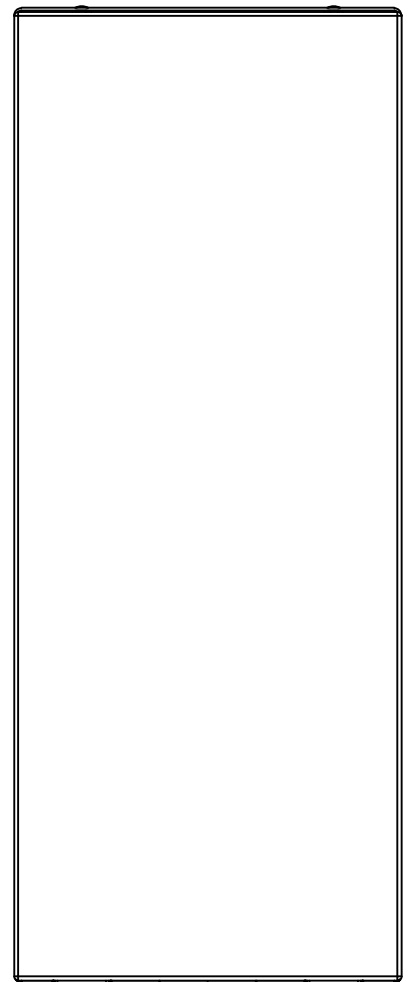

BACK

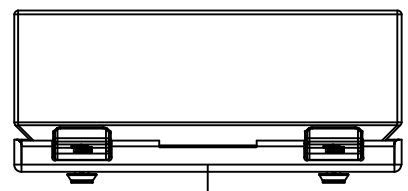

BOTTOM

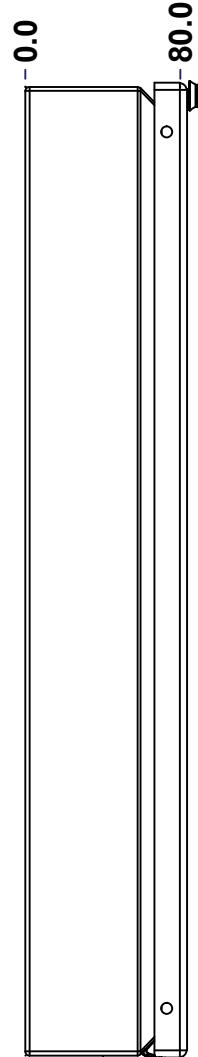

LEFT

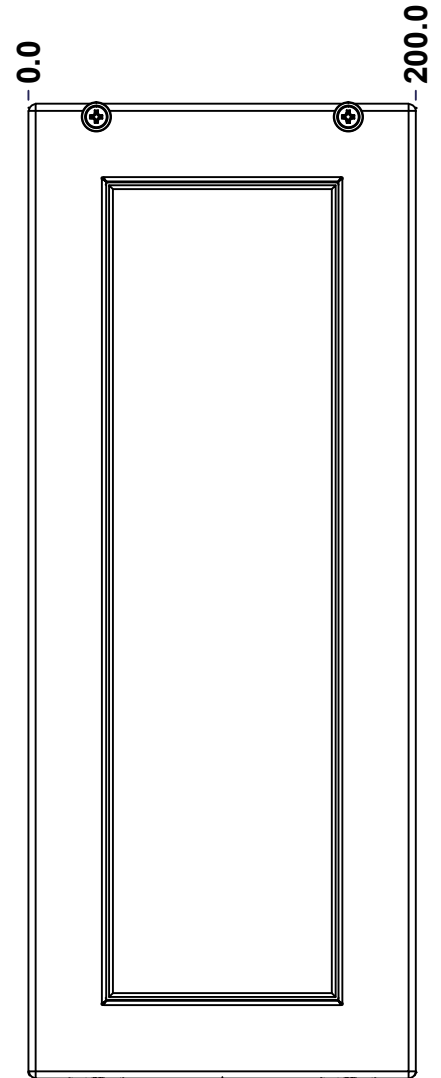

FRONT

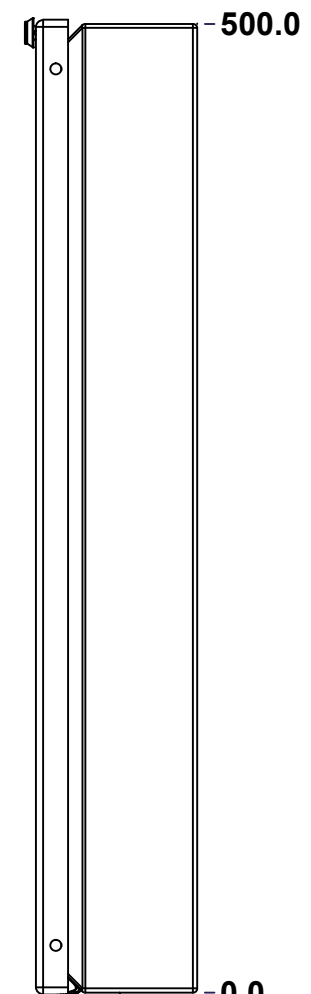

RIGHT

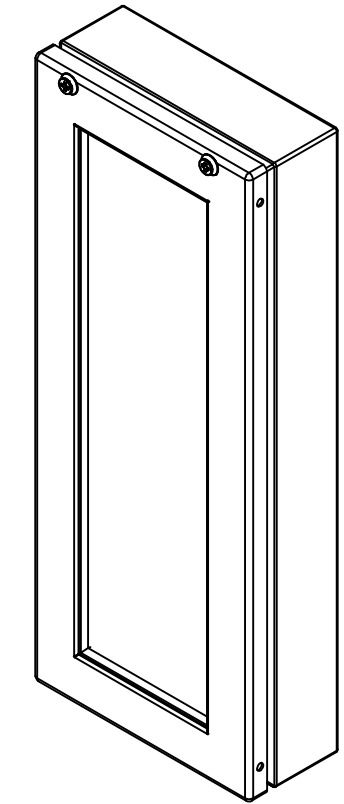

Isometric View



| No. | Revisions | Date | By/Par |
|-----|-----------|------|--------|
| | | | |
| | | | |
| | | | |
| | | | |
| | | | |

| | | |
|--|---|--|
| Tél: (450) 979-4373 Fax: (450) 979-4626 www.exmweb.com | | Flatness Aplatissement Max 3.0mm Projection |
| Customer Client | Date | |
| Drawn By Dessiné Par | BoxCad: BoxCad | Date 31-Mar-16 |
| Material Matière | 16 Ga Cold Rolled A1008 CS Type B (1.4mm) | |
| Color Couleur | Light Grey RAL7035 | Finish Fini Textured |
| Description | 6412ESCHWTB 500mm x 200mm x 80mm Assembly | |
| Part Number Numéro Pièce | 6412ESCHWTB502008 | Detail Rev. Rev. 1/9 |

SEE BILL OF MATERIAL ON LAST PAGE

This drawing is confidential and must not be reproduced or used without the consent of EXM

Ce dessin est confidentiel et ne doit pas être reproduit ou utilisé sans le consentement de EXM

| NOTE | |
|------|--|
| ITEM | DESCRIPTION |
| 1 | NEMA 4, 12 Enclosure (IP66) |
| 2 | C/W Standard ground standoffs on box and cover |
| 3 | W/O Standard door stiffener |
| 4 | W/O Inner panel |
| 5 | C/W Standard inner panel mounting standoffs |

| No. | Revisions | Date | By/Par |
|-----|-----------|------|--------|
| | | | |
| | | | |
| | | | |
| | | | |
| | | | |
| | | | |

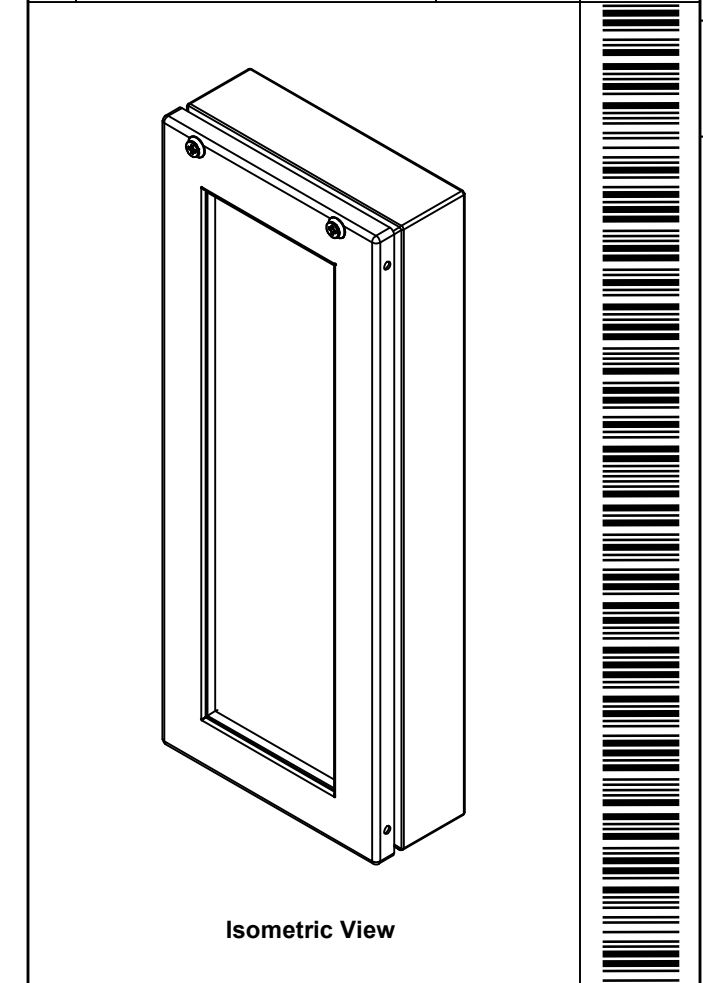

Tél: (450) 979-4373
Fax: (450) 979-4626
www.exmweb.com

Flatness
Aplatissement
Max 3.0mm

Projection

| | |
|---|----------------|
| Customer Client | Date |
| Drawn By Dessiné Par BoxCad: BoxCad | Date 31-Mar-16 |
| Material Matière 16 Ga Cold Rolled A1008 CS Type B (1.4mm) | |

| PACKING | | |
|------------------|-----|--|
| ITEM | QTY | DESCRIPTION |
| Cardboard sleeve | 2 | Top and Bottom |
| Cardboard strip | 2 | Between back of enclosure and inner panel |
| Plastic bag | 1 | To protect cover surface and inside gasket |
| Packaging label | 1 | White label with product number |

| | | | |
|------------|-----------------------|-----|---|
| 1 | 6412ESCHWTB502008C | 0 | 6412ESCHWTB 500mm x 200mm Cover |
| 2 | 6412ESCHWTB502008BR-P | 0 | 6412ESCHWTB 500mm Bracket Part |
| 1 | STK-K-02920 | 3 | 5412 ESSC Accessory Kit |
| 1 | 6412ESCHWTB502008B | 0 | 6412ESCHWTB 500mm x 200mm x 80mm Body |
| 2 | STK-A-08126 | 0 | M5 Stainless Steel 316 Nylon Insert Lock Nut with Incorporated Sealing Washer |
| Qty | Part Number | Rev | Description |
| Parts List | | | |

| | |
|--|------------------------------|
| Color Couleur Light Grey RAL7035 | Finish Fini Textured |
| Description 6412ESCHWTB 500mm x 200mm x 80mm Assembly | |
| Part Number Numéro Pièce 6412ESCHWTB502008 | Detail Rev. Rev. 0 |



This drawing is confidential and must not be reproduced or used without the consent of EXM

Ce dessin est confidentiel et ne doit pas être reproduit ou utilisé sans le consentement de EXM

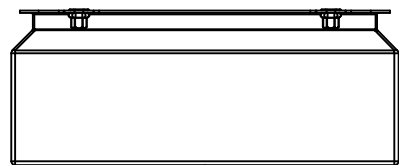

TOP

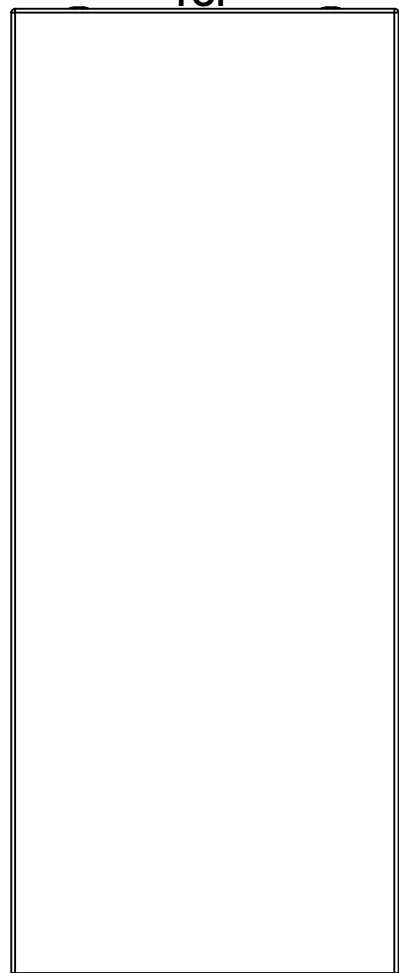

BACK



BOTTOM

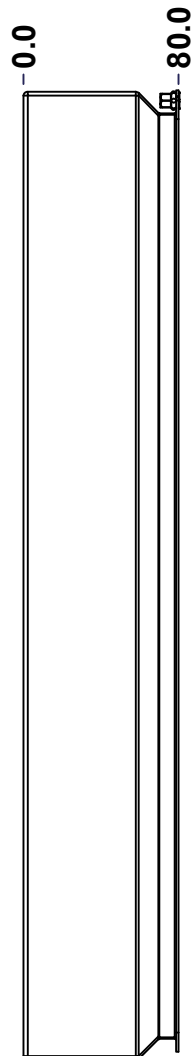

LEFT

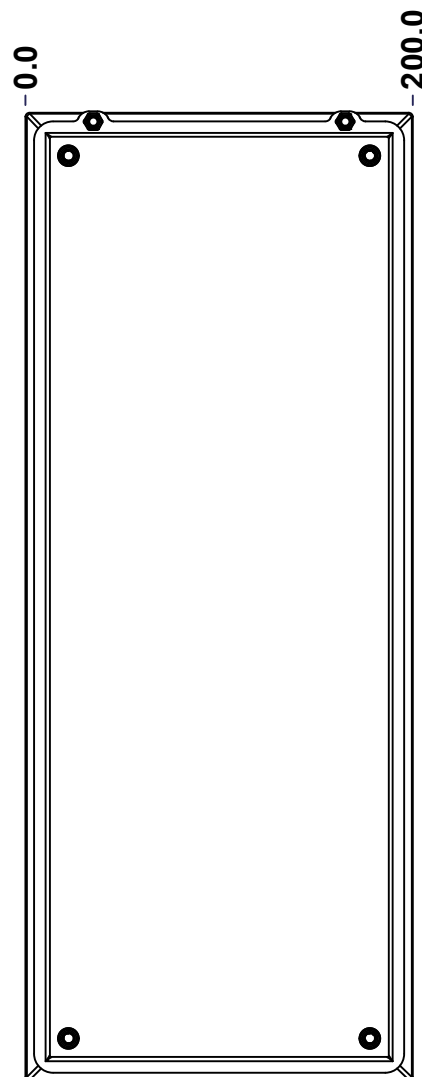

FRONT

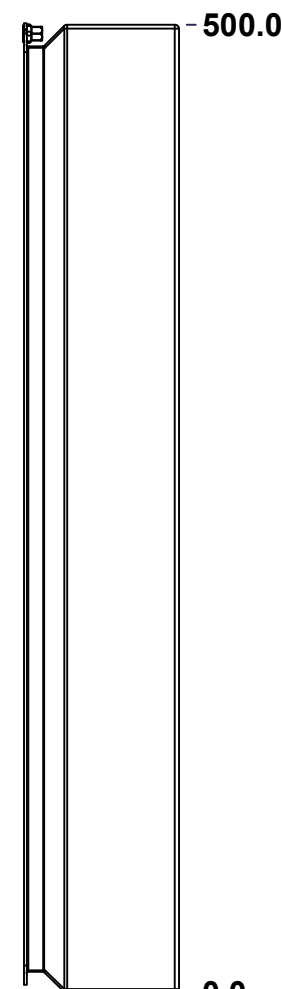

RIGHT

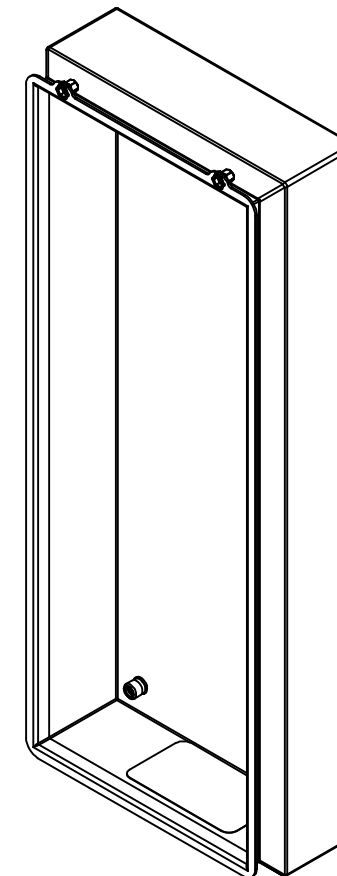

Isometric View



| No. | Revisions | Date | By/Par |
|-----|-----------|------|--------|
| | | | |
| | | | |
| | | | |
| | | | |
| | | | |

| | | |
|--|---|---|
|  Tél: (450) 979-4373 Fax: (450) 979-4626 www.exmweb.com | | Flatness Aplatissement Max 3.0mm Projection  |
| Customer Client | Date | |
| Drawn By Dessiné Par | BoxCad: BoxCad | Date 31-Mar-16 |
| Material Matière | 16 Ga Cold Rolled A1008 CS Type B (1.4mm) | |
| Color Couleur | Light Grey RAL7035 | Finish Fini Textured |
| Description | Detail Rev. | |
| 6412ESCHWTB 500mm x 200mm x 80mm Body | | |
| Part Number Numéro Pièce | Rev. | 3 |
| 6412ESCHWTB502008B | 0 | 9 |

SEE BILL OF MATERIAL ON LAST PAGE

This drawing is confidential and must not be reproduced or used without the consent of EXM

Ce dessin est confidentiel et ne doit pas être reproduit ou utilisé sans le consentement de EXM

STANDARD FEATURES ARE NOT LISTED IN THIS HOLE TABLE

HOLE TABLE - RIGHT VIEW (CUSTOM FEATURE ONLY)

| CUT-OUT | XDIM | YDIM | DESCRIPTION |
|---------|------|------|-----------------------------|
| 1 | 37.2 | 22.2 | STANDOFF M6 x 10mm (Inside) |

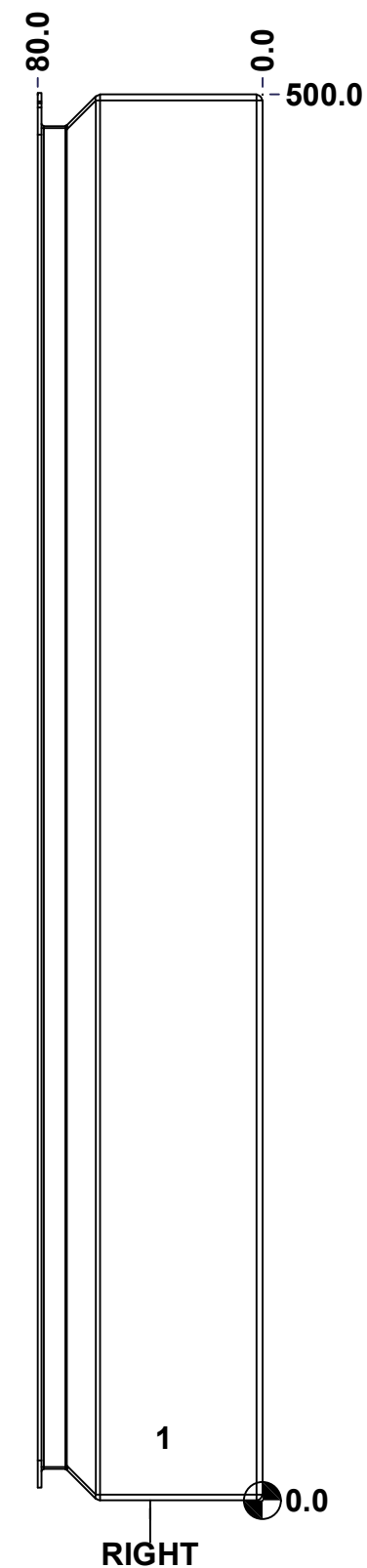

| | | |
|--|---|------------------------|
| | Description 6412ESCHWTB 500mm x 200mm x 72.1mm Body | Status (NULL) |
| | Part Number Numéro Pièce 6412ESCHWTB502008B | Rev. 4 0 / 9 |

This drawing is confidential and must not be reproduced or used without the consent of EXM

Ce dessin est confidentiel et ne doit pas être reproduit ou utilisé sans le consentement de EXM

| STANDARD FEATURES ARE NOT LISTED IN THIS HOLE TABLE | | | |
|--|-------|------|-------------|
| HOLE TABLE - BOTTOM VIEW (CUSTOM FEATURE ONLY) | | | |
| CUT-OUT | XDIM | YDIM | DESCRIPTION |
| 1 | 102.4 | 27.6 | LABEL_EXM |

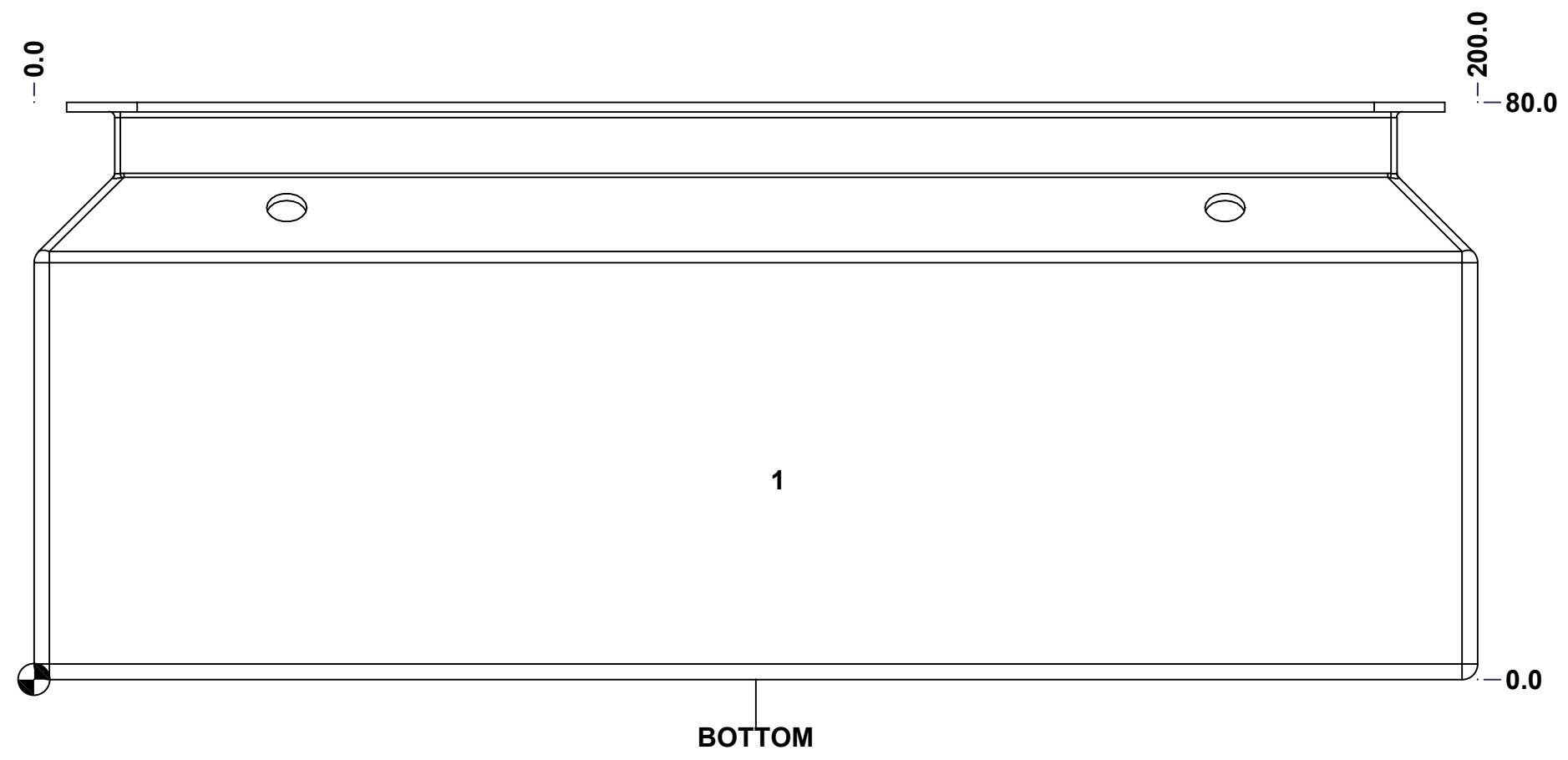

| | | |
|--|---|------------------------|
| | Description 6412ESCHWTB 500mm x 200mm x 72.1mm Body | Status (NULL) |
| | Part Number Numéro Pièce 6412ESCHWTB502008B | Rev. 5 0 / 9 |

This drawing is confidential and must not be reproduced or used without the consent of EXM

Ce dessin est confidentiel et ne doit pas être reproduit ou utilisé sans le consentement de EXM

STANDARD FEATURES ARE NOT LISTED IN THIS HOLE TABLE

HOLE TABLE - BACK VIEW (CUSTOM FEATURE ONLY)

| CUT-OUT | XDIM | YDIM | DESCRIPTION |
|---------|-------|-------|--------------------------------|
| 1 | 22.2 | 22.2 | IP STANDOFF M6 x 10mm (Inside) |
| 2 | 22.2 | 477.8 | IP STANDOFF M6 x 10mm (Inside) |
| 3 | 177.8 | 477.8 | IP STANDOFF M6 x 10mm (Inside) |
| 4 | 177.8 | 22.2 | IP STANDOFF M6 x 10mm (Inside) |

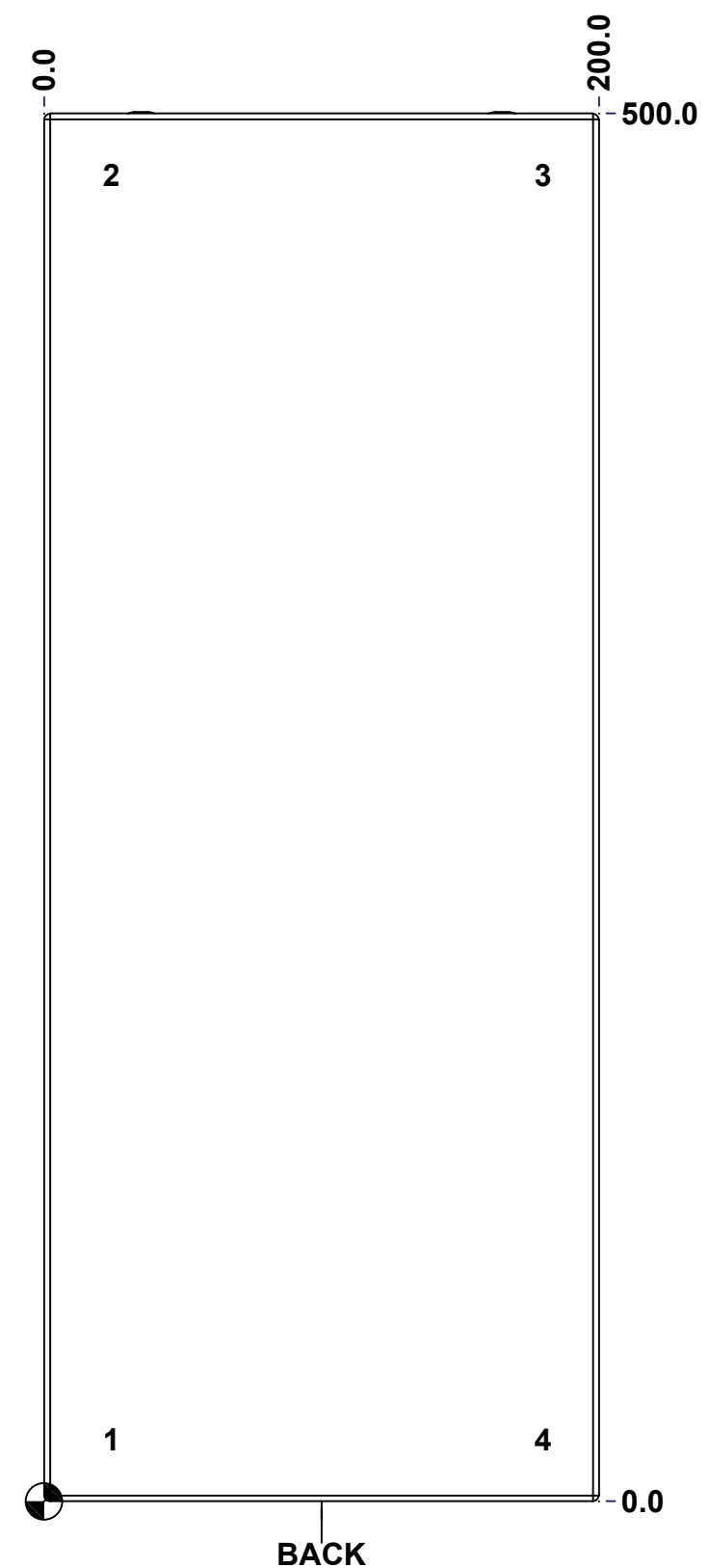



| | | | |
|--|---|--|------------------------|
| | Description 6412ESCHWTB 500mm x 200mm x 72.1mm Body | | Status (NULL) |
| | Part Number Numéro Pièce 6412ESCHWTB502008B | | Rev. 0 / 6 9 |

This drawing is confidential and must not be reproduced or used without the consent of EXM

Ce dessin est confidentiel et ne doit pas être reproduit ou utilisé sans le consentement de EXM

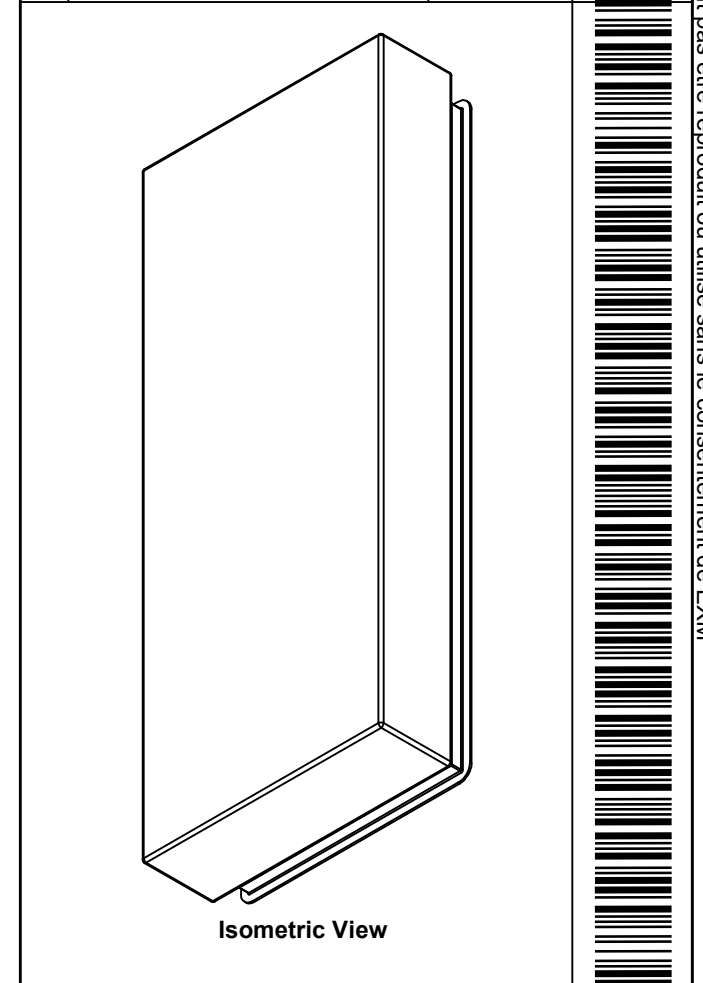
| No. | Revisions | Date | By/Par |
|-----|-----------|------|--------|
| | | | |
| | | | |
| | | | |
| | | | |
| | | | |

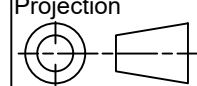

| | | |
|--|--|---|
|  Tél: (450) 979-4373 Fax: (450) 979-4626 www.exmweb.com | | Flatness Aplatissement Max 3.0mm |
| Customer Client | | Projection  |
| Drawn By Dessiné Par BoxCad: BoxCad | | Date 31-Mar-16 |
| Material Matière 16 Ga Cold Rolled A1008 CS Type B (1.4mm) | | |
| Color Couleur Light Grey RAL7035 | | Finish Fini Textured |
| Description 6412ESCHWTB 500mm x 200mm x 80mm Body | | Detail Rev. |
| Part Number Numéro Pièce 6412ESCHWTB502008B | | Rev. 0 |

| Qty | Part Number | Rev | Description |
|------------|----------------------|-----|--|
| 1 | STK-S-00100 | 0 | 3.5" x 2" Silver Milar Flexcon Sticker |
| 2 | RIVET_NUT_M5_FH_OE | 0 | Rivet Nut M5 (Low Profile Open End) |
| 1 | 6412ESCHWTB502008B-P | 0 | 6412ESCHWTB 500mm x 200mm x 72.1mm Body Part |
| 1 | STK-P-03820R | 0 | Powder Paint (Light Grey / Rough Textured) |
| 5 | STK-Q-08350 | 5 | Standoff M6 x 10mm |
| Parts List | | | |

This drawing is confidential and must not be reproduced or used without the consent of EXM

Ce dessin est confidentiel et ne doit pas être reproduit ou utilisé sans le consentement de EXM

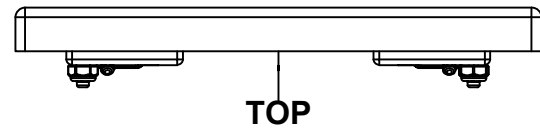

TOP

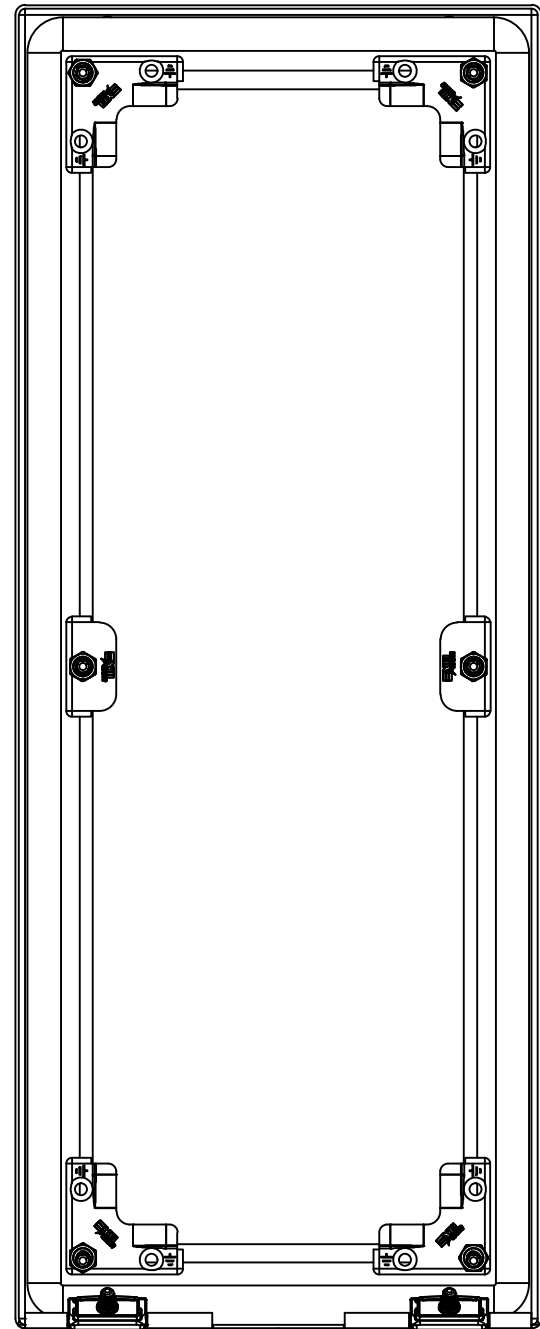

BACK



BOTTOM

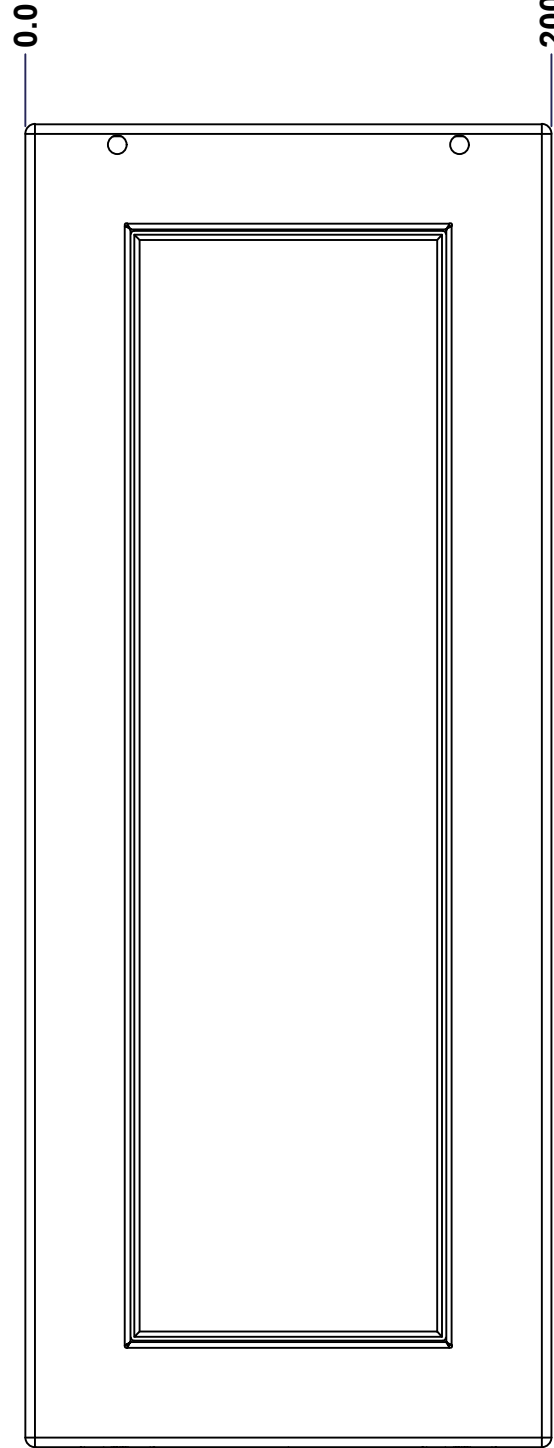
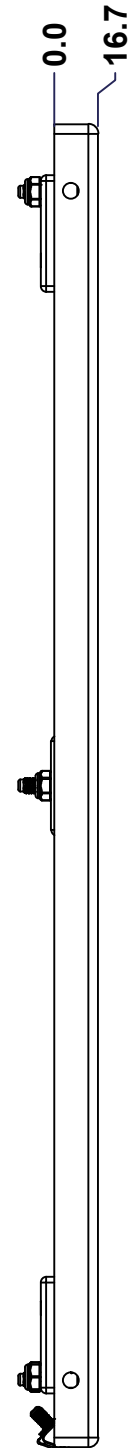

FRONT

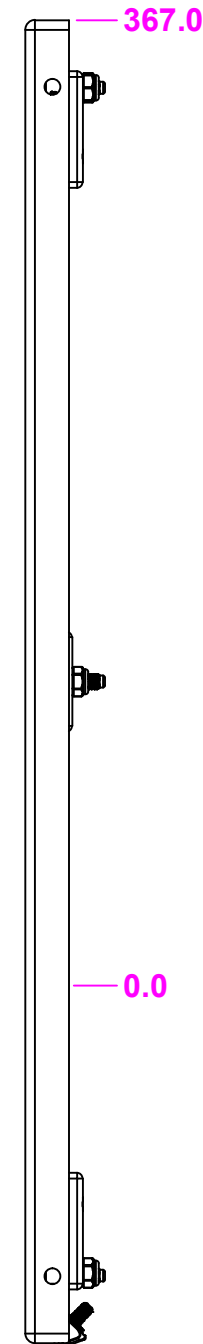

| No. | Revisions | Date | By/Par |
|-----|-----------|------|--------|
| | | | |
| | | | |
| | | | |
| | | | |

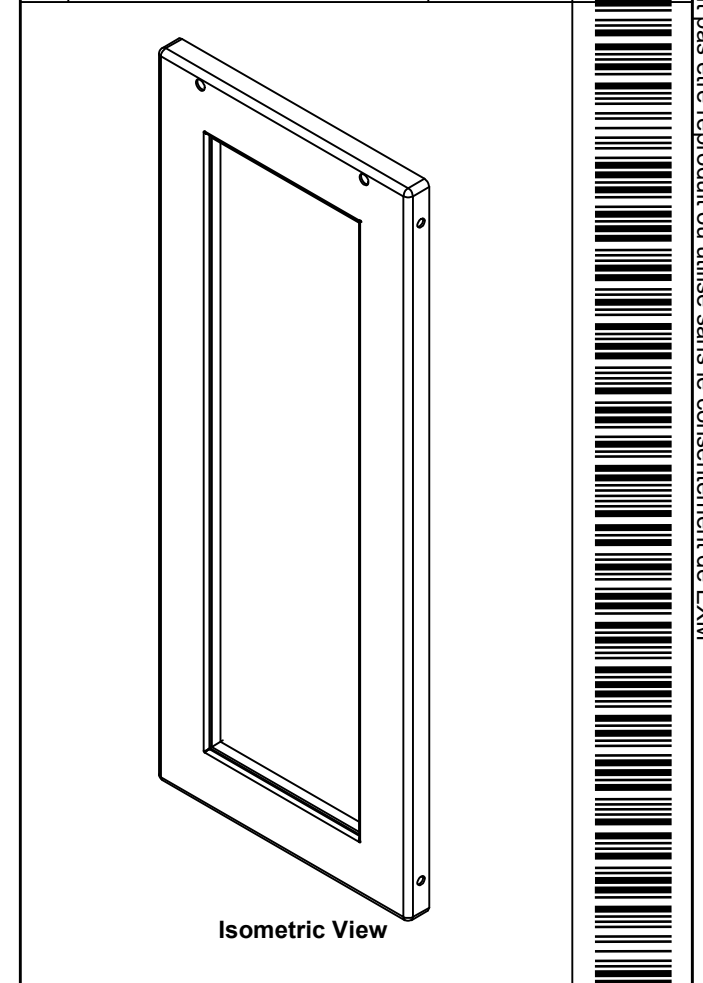

Isometric View

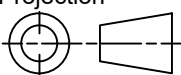

| | | |
|--|---|---|
|  Tél: (450) 979-4373 Fax: (450) 979-4626 www.exmweb.com | | Flatness Aplatissement Max 3.0mm Projection  |
| Customer Client | Date | |
| Drawn By Dessiné Par | BoxCad: BoxCad | Date 31-Mar-16 |
| Material Matière | 16 Ga Cold Rolled A1008 CS Type B (1.4mm) | |
| Color Couleur | Light Grey RAL7035 | Finish Fini Textured |
| Description | | Detail Rev. |
| 6412ESCHWTB 500mm x 200mm Cover | | |
| Part Number Numéro Pièce | Rev. | 8 |
| 6412ESCHWTB502008C | 0 | 9 |

SEE BILL OF MATERIAL ON LAST PAGE

This drawing is confidential and must not be reproduced or used without the consent of EXM

Ce dessin est confidentiel et ne doit pas être reproduit ou utilisé sans le consentement de EXM

| No. | Revisions | Date | By/Par |
|-----|-----------|------|--------|
| | | | |
| | | | |
| | | | |
| | | | |
| | | | |

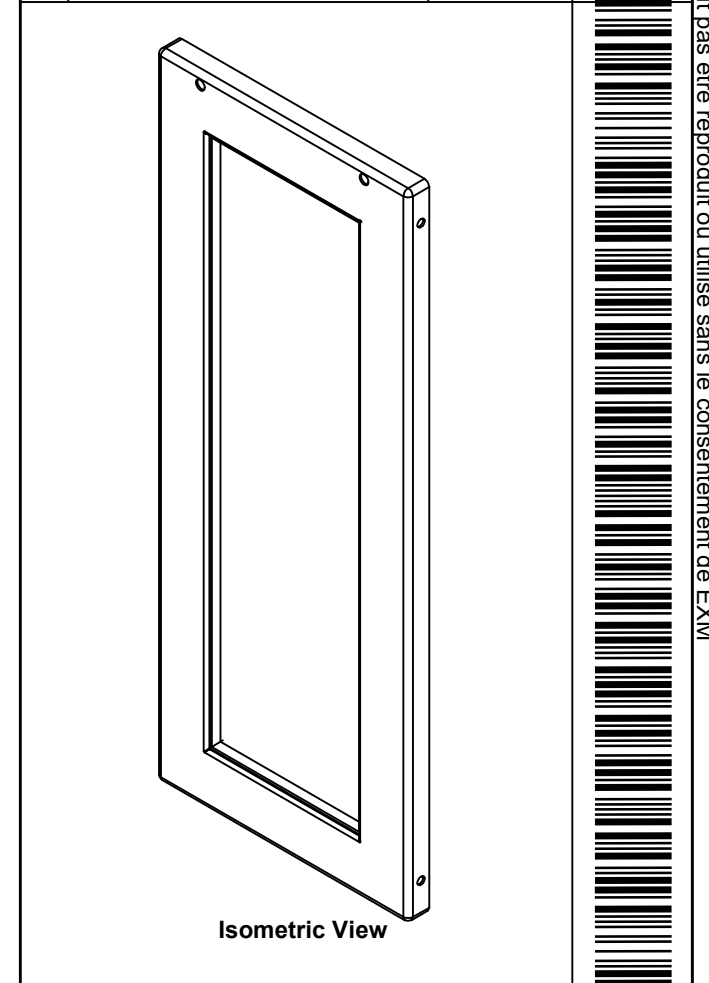

| 1 | STK-P-03820R | 0 | Powder Paint (Light Grey / Rough Textured) |
|------------|-----------------------|-----|--|
| 1 | STK-A-60703 | 0 | 5412 ESW Lexan Bracket Kit |
| 6 | STK-Q-16052 | 0 | M6 x 23mm Stud (No Paint Cap Required) |
| 1 | 6412ESCHWTB502008LX | 0 | 6412ESCHWTB Lexan 439mm x 141.1mm 6mm |
| 1 | 6412ESCHWTB502008LX G | 0 | 6412ESCHWTB 500mm x 200mm Lexan Gasket |
| 1 | STK-G-02705 | 0 | 880 HWKG - Windows Kit Gasket |
| 1 | 6412ESCHWTB502008G | 0 | 6412ESCHWTB 500mm x 200mm Gasket |
| 1 | 6412ESCHWTB502008C-P | 0 | 6412ESCHWTB 500mm x 200mm Cover Part |
| 2 | STK-A-33033 | 4 | 5412 ESMCH Hinge |
| 2 | STK-Q-60700 | 4 | 880 WK Lexan 1/4" Fixing Bracket |
| Qty | Part Number | Rev | Description |
| Parts List | | | |

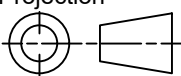
| | | |
|--|---|---|
|  Tél: (450) 979-4373 Fax: (450) 979-4626 www.exmweb.com | | Flatness Aplatissement Max 3.0mm Projection  |
| Customer Client | Date | |
| Drawn By Dessiné Par | BoxCad: BoxCad | Date 31-Mar-16 |
| Material Matière | 16 Ga Cold Rolled A1008 CS Type B (1.4mm) | |
| Color Couleur | Light Grey RAL7035 | Finish Fini Textured |
| Description | Detail Rev. | |
| 6412ESCHWTB 500mm x 200mm Cover | | |
| Part Number Numéro Pièce | Rev. | 9 |
| 6412ESCHWTB502008C | 0 | 9 |