

This drawing is confidential and must not be reproduced or used without the consent of EXM

Ce dessin est confidentiel et ne doit pas être reproduit ou utilisé sans le consentement de EXM

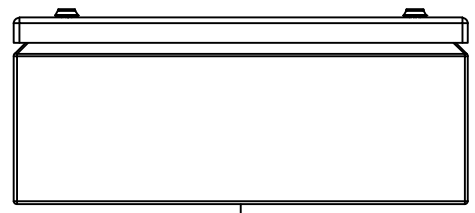

TOP

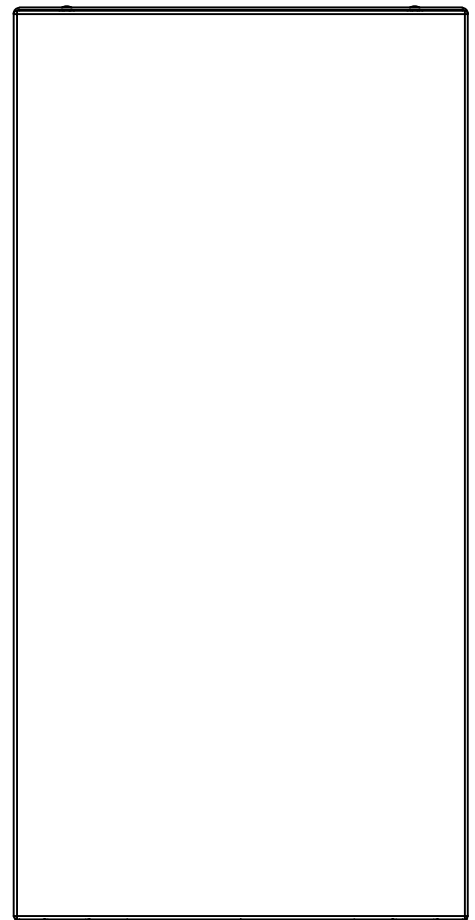

BACK

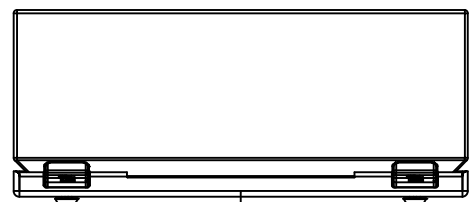

BOTTOM

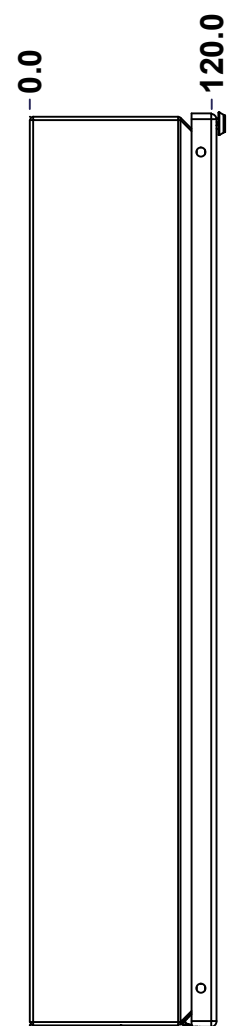

LEFT

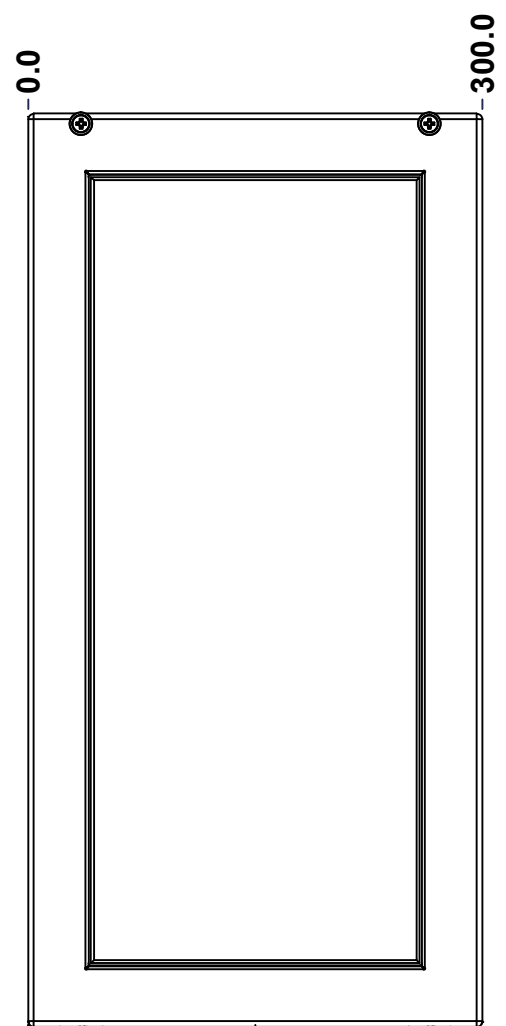

FRONT

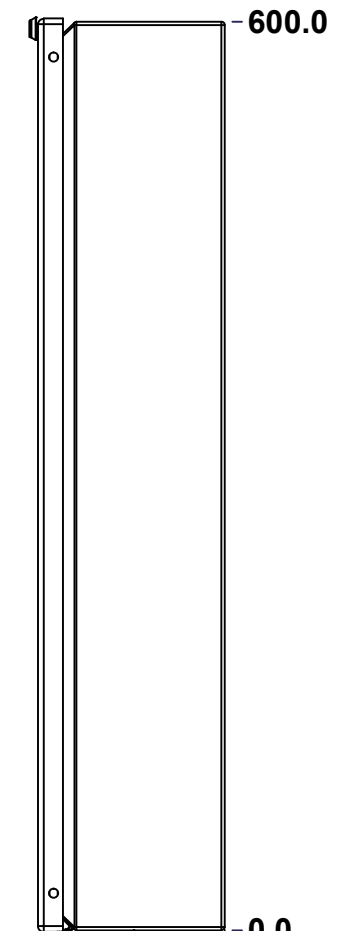

RIGHT

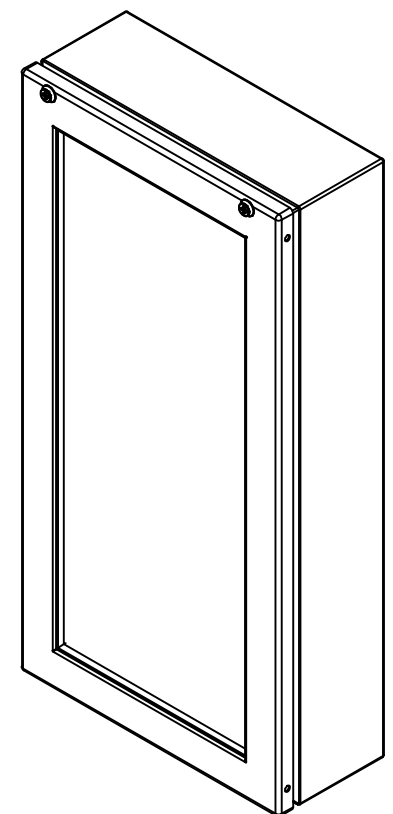

Isometric View

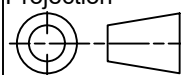

No.	Revisions	Date	By/Par

 Tél: (450) 979-4373 Fax: (450) 979-4626 www.exmweb.com		Flatness Aplatissement Max 3.0mm Projection 
Customer Client	Date	
Drawn By Dessiné Par	BoxCad: BoxCad	Date 09-Jan-25
Material Matière	16 Ga Cold Rolled A1008 CS Type B (1.4mm)	
Color Couleur	Light Grey RAL7035	Finish Fini Textured
Description 6412ESCHWTB 600mm x 300mm x 120mm Assembly		Detail Rev.
Part Number Numéro Pièce	6412ESCHWTB603012	Rev. 1 0

SEE BILL OF MATERIAL ON LAST PAGE

This drawing is confidential and must not be reproduced or used without the consent of EXM

Ce dessin est confidentiel et ne doit pas être reproduit ou utilisé sans le consentement de EXM

NOTE	
ITEM	DESCRIPTION
1	NEMA 4, 12 Enclosure (IP66)
2	C/W Standard ground standoffs on box and cover
3	W/O Standard door stiffener
4	W/O Inner panel
5	C/W Standard inner panel mounting standoffs

No.	Revisions	Date	By/Par

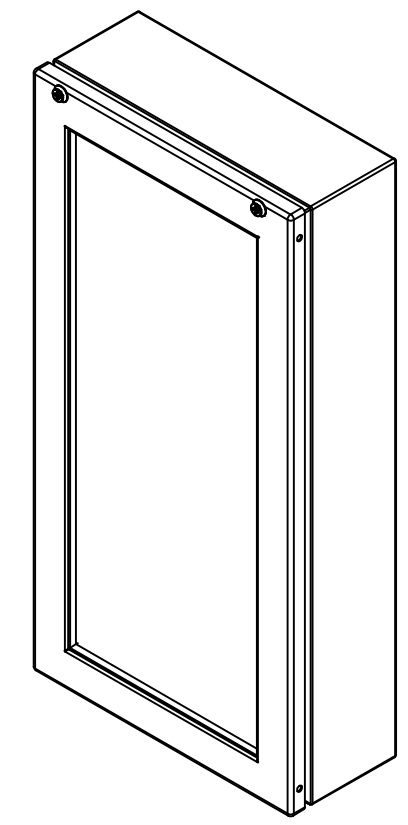

Isometric View



Tél: (450) 979-4373
 Fax: (450) 979-4626
www.exmweb.com



Customer Client	Date
Drawn By / Dessiné Par: BoxCad: BoxCad	Date: 09-Jan-25
Material / Matière: 16 Ga Cold Rolled A1008 CS Type B (1.4mm)	

Color / Couleur: Light Grey RAL7035	Finish / Fini: Textured
Description: 6412ESCHWTB 600mm x 300mm x 120mm Assembly	
Part Number / Numéro Pièce: 6412ESCHWTB603012	Rev. 0

PACKING		
ITEM	QTY	DESCRIPTION
Cardboard sleeve	2	Top and Bottom
Cardboard strip	2	Between back of enclosure and inner panel
Plastic bag	1	To protect cover surface and inside gasket
Packaging label	1	White label with product number

Qty	Part Number	Rev	Description
1	6412ESCHWTB603012C	0	6412ESCHWTB 600mm x 300mm Cover
2	6412ESCHWTB603012BR-P	0	6412ESCHWTB 600mm Bracket Part
1	STK-K-02920	3	5412 ESSC Accessory Kit
1	6412ESCHWTB603012B	0	6412ESCHWTB 600mm x 300mm x 120mm Body
2	STK-A-08126	0	M5 Stainless Steel 316 Nylon Insert Lock Nut with Incorporated Sealing Washer

Parts List

This drawing is confidential and must not be reproduced or used without the consent of EXM

Ce dessin est confidentiel et ne doit pas être reproduit ou utilisé sans le consentement de EXM

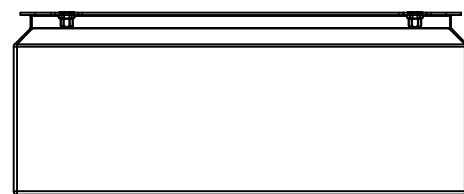

TOP

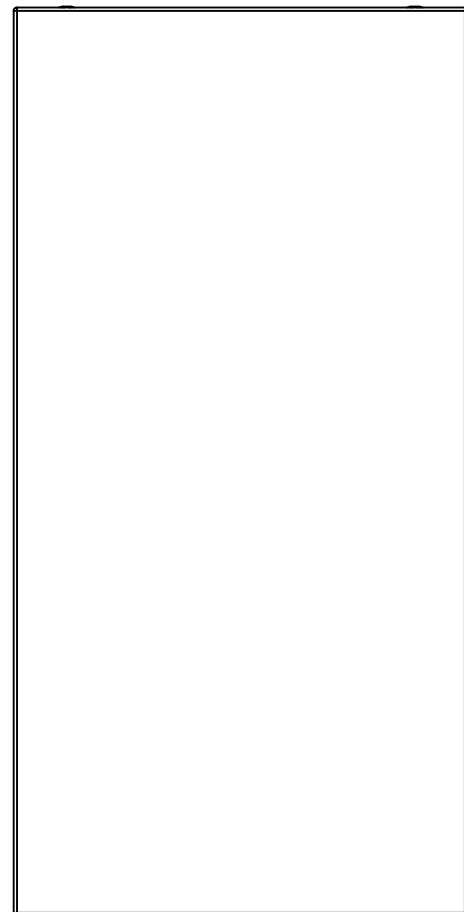

BACK

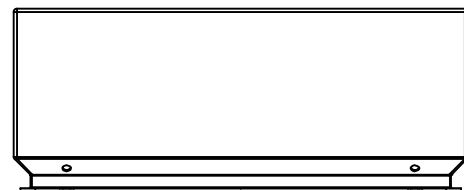

BOTTOM

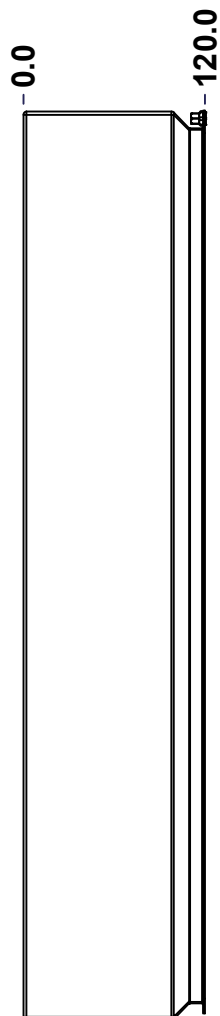

LEFT

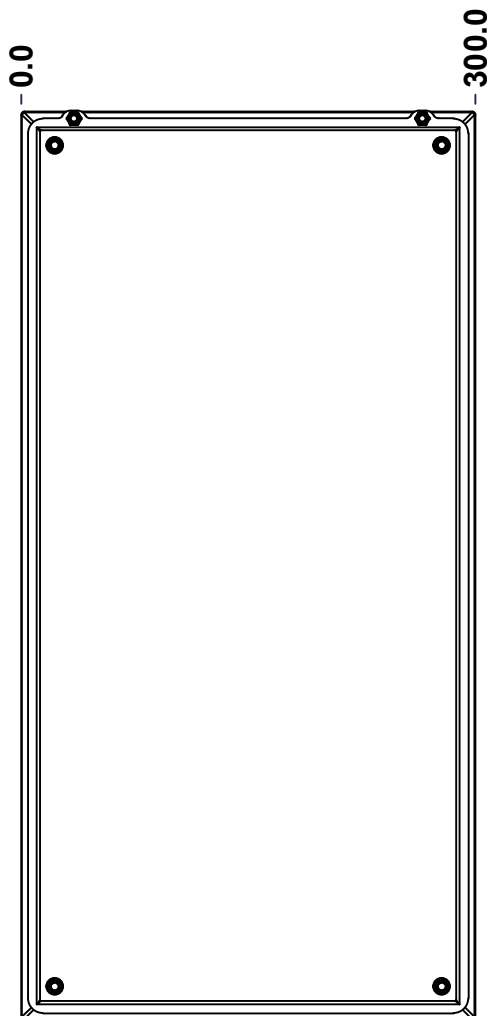

FRONT

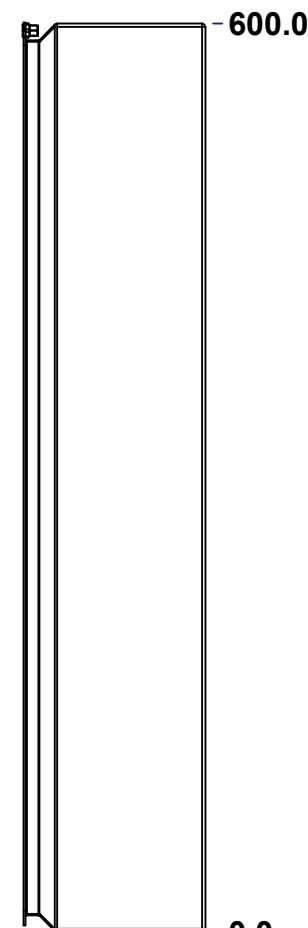

RIGHT

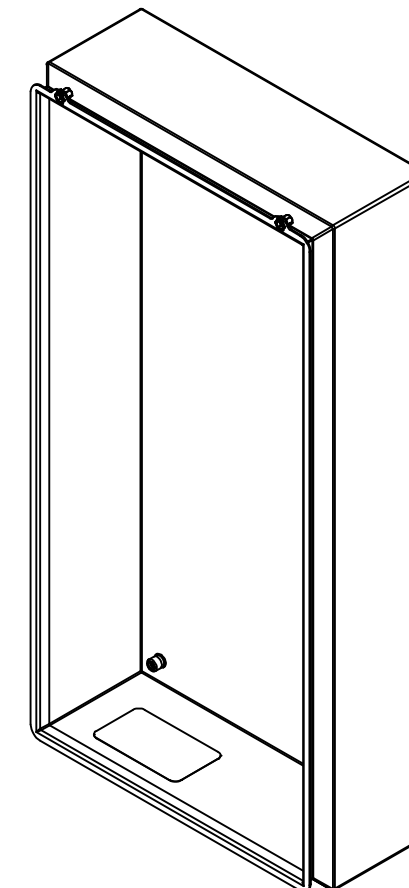

Isometric View

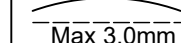

No.	Revisions	Date	By/Par

 Tél: (450) 979-4373 Fax: (450) 979-4626 www.exmweb.com		Flatness Aplatissement  Max 3.0mm
Customer Client		Date
Drawn By Dessiné Par BoxCad: BoxCad		Date 09-Jan-25
Material Matière 16 Ga Cold Rolled A1008 CS Type B (1.4mm)		
Color Couleur Light Grey RAL7035	Finish Fini Textured	
Description 6412ESCHWTB 600mm x 300mm x 120mm Body		Detail Rev.
Part Number Numéro Pièce 6412ESCHWTB603012B		Rev. 3 0

SEE BILL OF MATERIAL ON LAST PAGE

This drawing is confidential and must not be reproduced or used without the consent of EXM

Ce dessin est confidentiel et ne doit pas être reproduit ou utilisé sans le consentement de EXM

STANDARD FEATURES ARE NOT LISTED IN THIS HOLE TABLE			
HOLE TABLE - RIGHT VIEW (CUSTOM FEATURE ONLY)			
CUT-OUT	XDIM	YDIM	DESCRIPTION
1	77.2	22.2	STANDOFF M6 x 10mm (Inside)

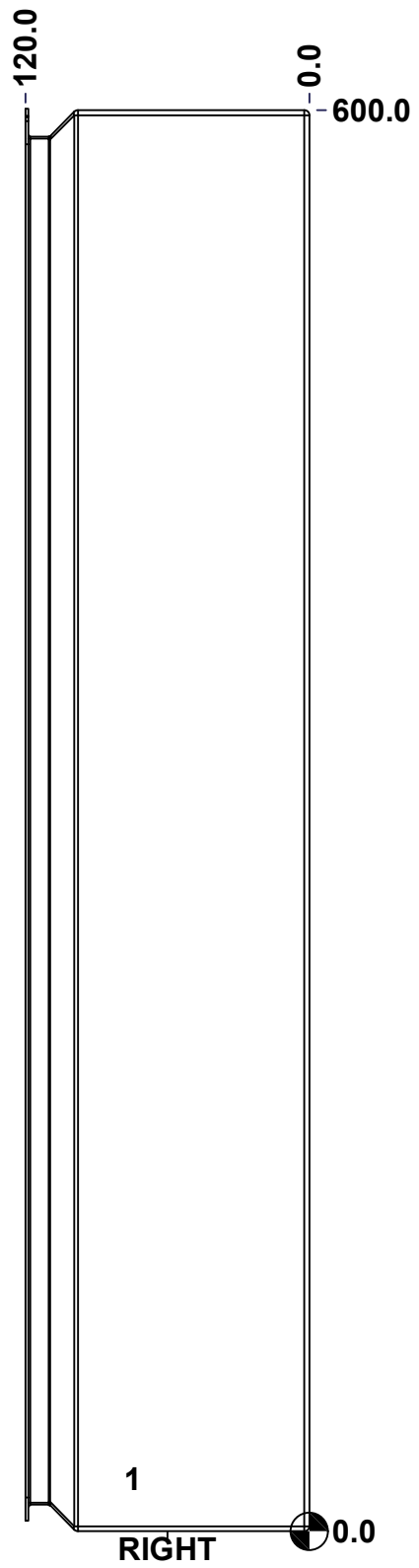

	Description 6412ESCHWTB 600mm x 300mm x 112.1mm Body	Status (NULL)
	Part Number Numéro Pièce 6412ESCHWTB603012B	Rev. 4 0 / 9

This drawing is confidential and must not be reproduced or used without the consent of EXM

Ce dessin est confidentiel et ne doit pas être reproduit ou utilisé sans le consentement de EXM

STANDARD FEATURES ARE NOT LISTED IN THIS HOLE TABLE

HOLE TABLE - BOTTOM VIEW (CUSTOM FEATURE ONLY)

CUT-OUT	XDIM	YDIM	DESCRIPTION
1	76.2	59.7	LABEL_EXM

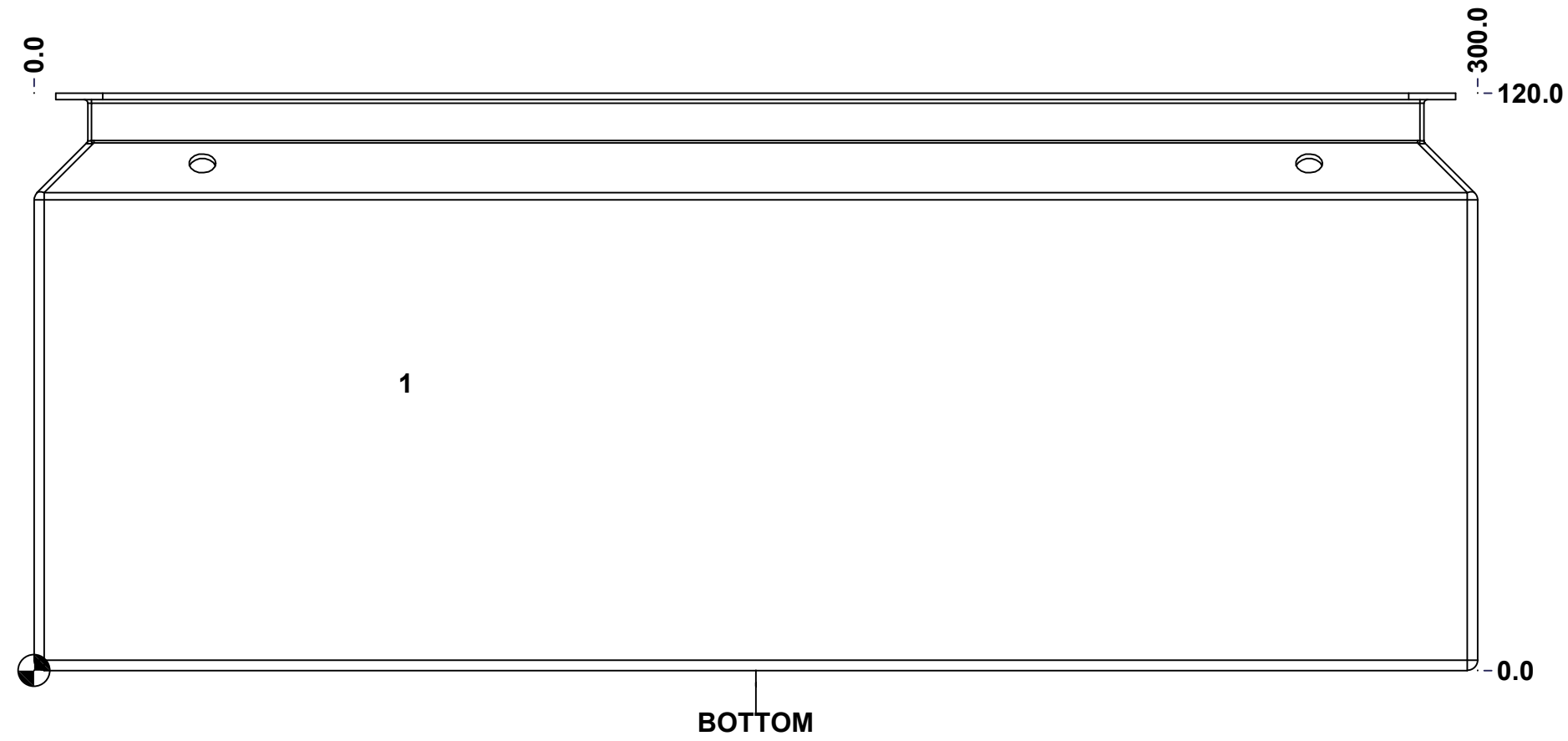

	Description 6412ESCHWTB 600mm x 300mm x 112.1mm Body	Status (NULL)
	Part Number Numéro Pièce 6412ESCHWTB603012B	Rev. 5 0 / 9

This drawing is confidential and must not be reproduced or used without the consent of EXM

Ce dessin est confidentiel et ne doit pas être reproduit ou utilisé sans le consentement de EXM

STANDARD FEATURES ARE NOT LISTED IN THIS HOLE TABLE

HOLE TABLE - BACK VIEW (CUSTOM FEATURE ONLY)

CUT-OUT	XDIM	YDIM	DESCRIPTION
1	22.2	22.2	IP STANDOFF M6 x 10mm (Inside)
2	22.2	577.8	IP STANDOFF M6 x 10mm (Inside)
3	277.8	577.8	IP STANDOFF M6 x 10mm (Inside)
4	277.8	22.2	IP STANDOFF M6 x 10mm (Inside)





	Description 6412ESCHWTB 600mm x 300mm x 112.1mm Body	Status (NULL)
	Part Number Numéro Pièce 6412ESCHWTB603012B	Rev. 6 0 / 9

This drawing is confidential and must not be reproduced or used without the consent of EXM

Ce dessin est confidentiel et ne doit pas être reproduit ou utilisé sans le consentement de EXM

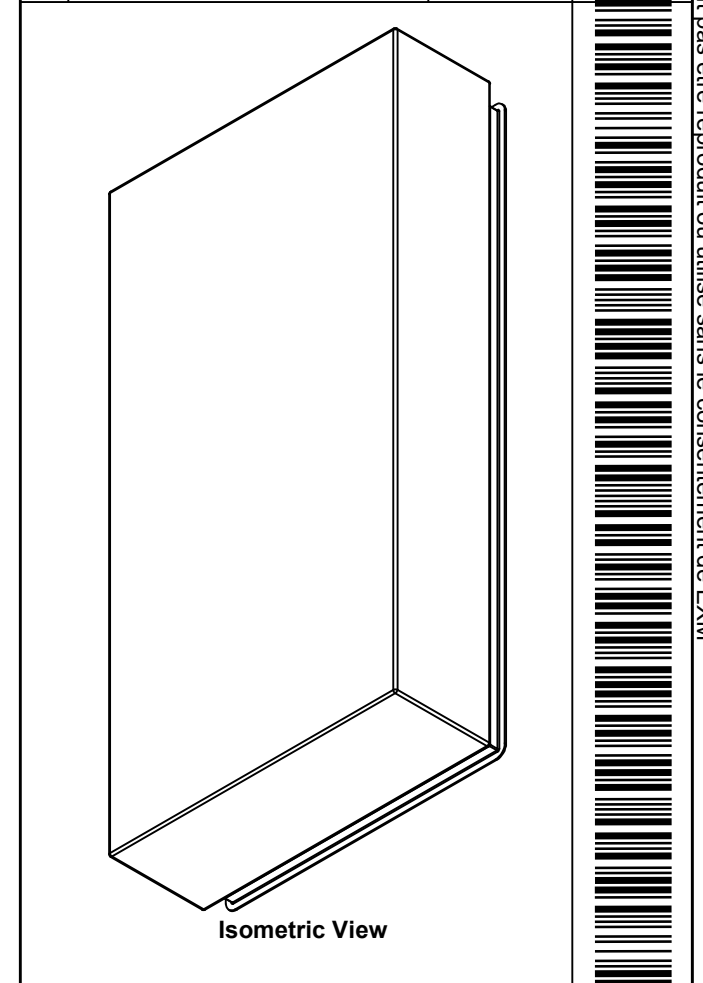
No.	Revisions	Date	By/Par

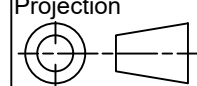

 Tél: (450) 979-4373 Fax: (450) 979-4626 www.exmweb.com		Flatness Aplatissement Max 3.0mm
Customer Client		Projection 
Drawn By / Dessiné Par: BoxCad: BoxCad		Date: 09-Jan-25
Material / Matière: 16 Ga Cold Rolled A1008 CS Type B (1.4mm)		
Color / Couleur: Light Grey RAL7035		Finish / Fini: Textured
Description: 6412ESCHWTB 600mm x 300mm x 120mm Body		Detail Rev.
Part Number / Numéro Pièce: 6412ESCHWTB603012B		Rev. 7 0 9

Qty	Part Number	Rev	Description
1	STK-S-00100	0	3.5" x 2" Silver Milar Flexcon Sticker
2	RIVET_NUT_M5_FH_OE	0	Rivet Nut M5 (Low Profile Open End)
1	6412ESCHWTB603012B-P	0	6412ESCHWTB 600mm x 300mm x 112.1mm Body Part
1	STK-P-03820R	0	Powder Paint (Light Grey / Rough Textured)
5	STK-Q-08350	5	Standoff M6 x 10mm
Parts List			

This drawing is confidential and must not be reproduced or used without the consent of EXM

Ce dessin est confidentiel et ne doit pas être reproduit ou utilisé sans le consentement de EXM

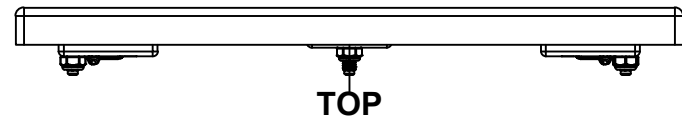

TOP

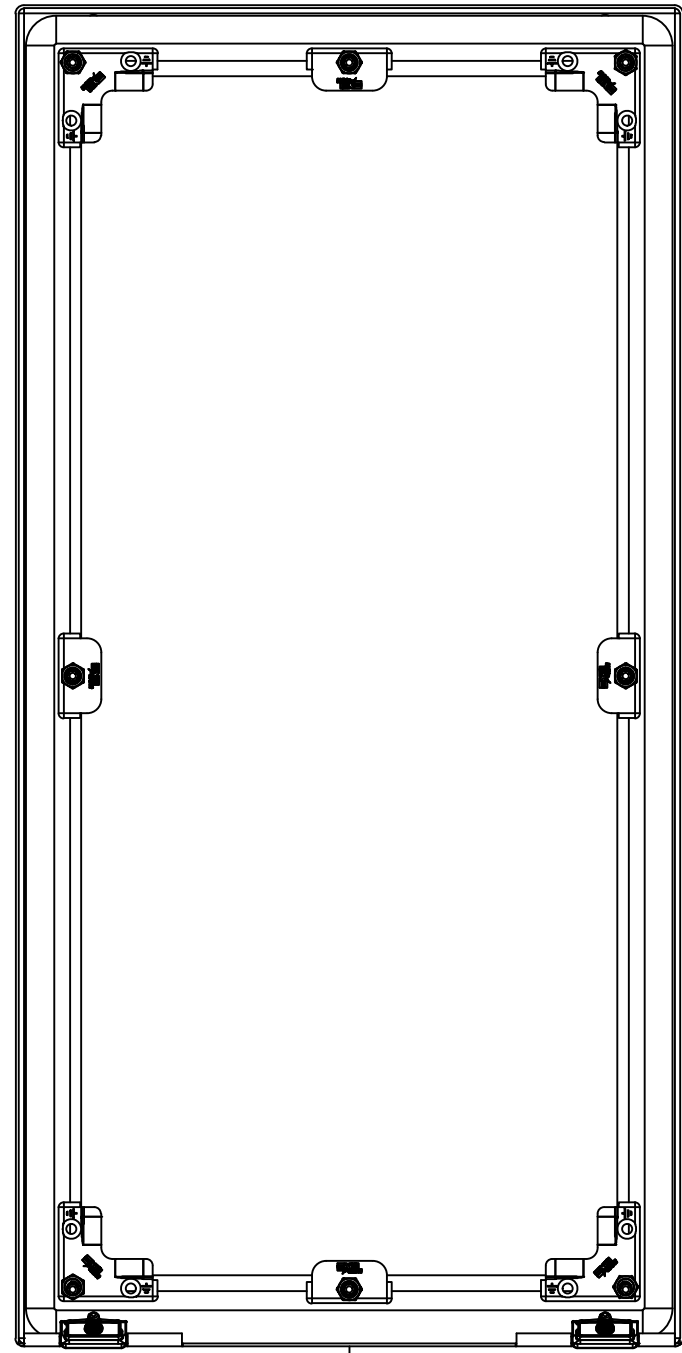

0.0
16.7

0.0

300.0

438.0

0.0



BACK



BOTTOM

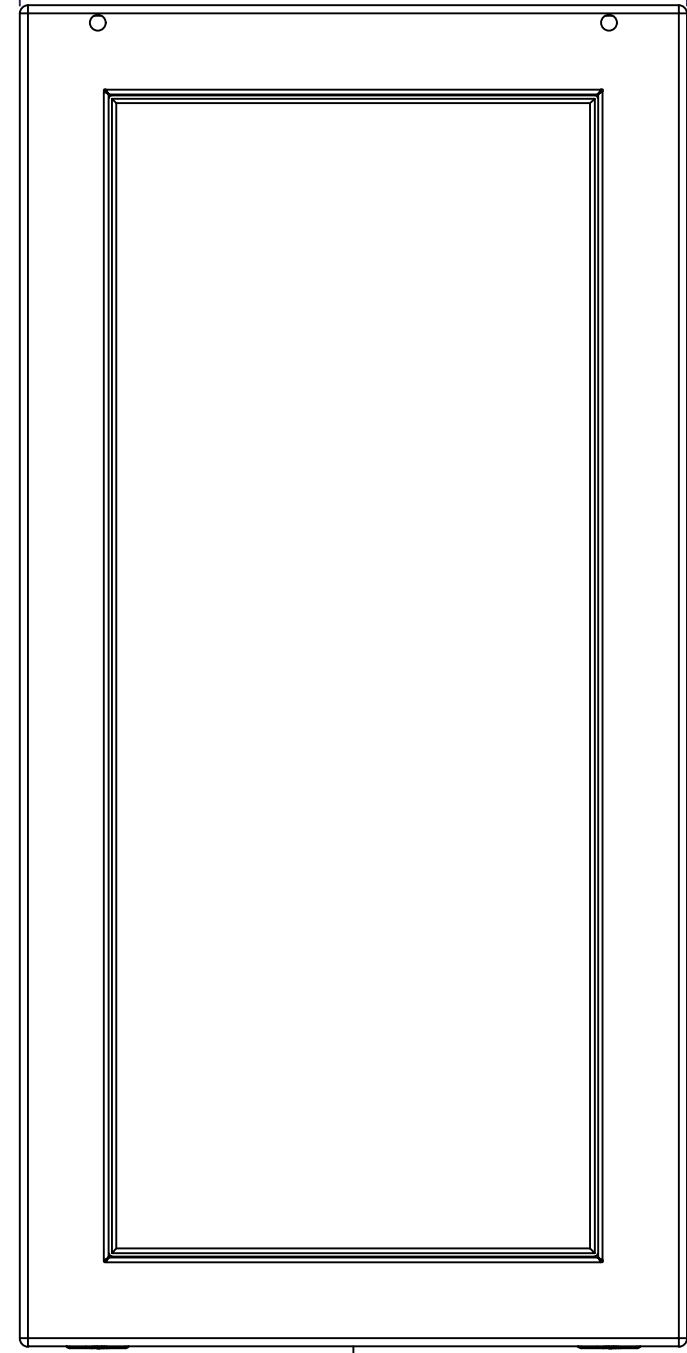

FRONT

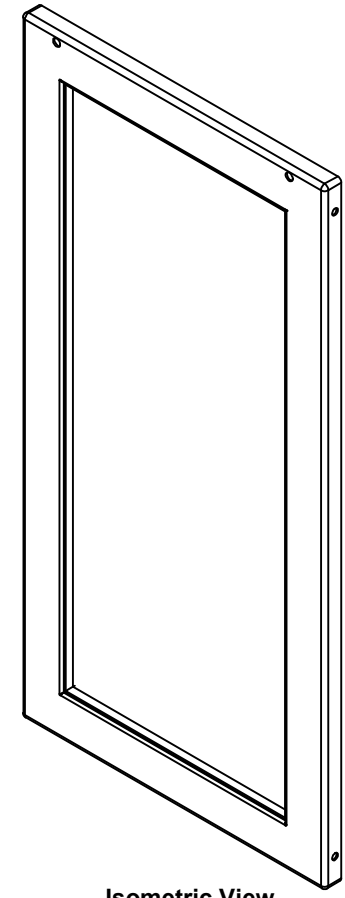
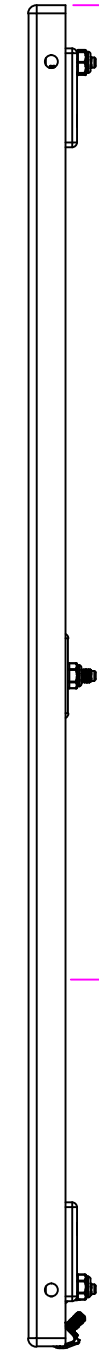

Isometric View

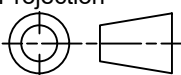

No.	Revisions	Date	By/Par

 Tél: (450) 979-4373 Fax: (450) 979-4626 www.exmweb.com		Flatness Aplatissement Max 3.0mm Projection 
Customer Client	Date	
Drawn By Dessiné Par	BoxCad: BoxCad	Date 09-Jan-25
Material Matière	16 Ga Cold Rolled A1008 CS Type B (1.4mm)	
Color Couleur	Light Grey RAL7035	Finish Fini Textured
Description	Detail Rev.	
6412ESCHWTB 600mm x 300mm Cover		
Part Number Numéro Pièce	Rev.	8
6412ESCHWTB603012C	0	9

SEE BILL OF MATERIAL ON LAST PAGE

This drawing is confidential and must not be reproduced or used without the consent of EXM

Ce dessin est confidentiel et ne doit pas être reproduit ou utilisé sans le consentement de EXM

No.	Revisions	Date	By/Par

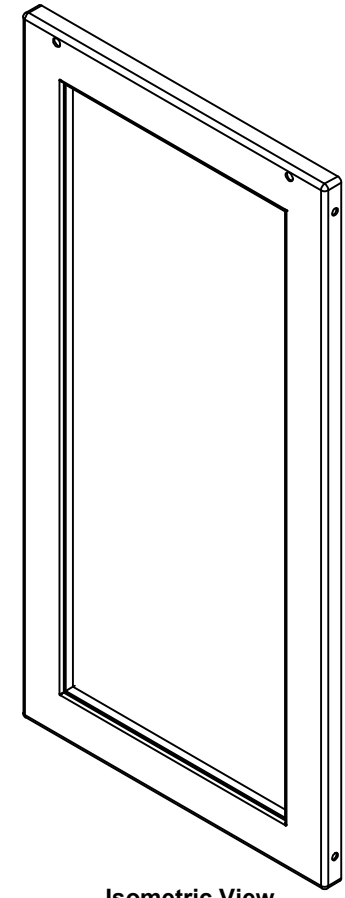

Isometric View

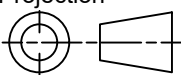

1	STK-P-03820R	0	Powder Paint (Light Grey / Rough Textured)
1	STK-A-60703	0	5412 ESW Lexan Bracket Kit
8	STK-Q-16052	0	M6 x 23mm Stud (No Paint Cap Required)
1	6412ESCHWTB603012LX	0	6412ESCHWTB Lexan 539mm x 241.1mm 6mm
1	6412ESCHWTB603012LX G	0	6412ESCHWTB 600mm x 300mm Lexan Gasket
1	STK-G-02705	0	880 HWKG - Windows Kit Gasket
1	6412ESCHWTB603012G	0	6412ESCHWTB 600mm x 300mm Gasket
1	6412ESCHWTB603012C-P	0	6412ESCHWTB 600mm x 300mm Cover Part
2	STK-A-33033	4	5412 ESMCH Hinge
4	STK-Q-60700	4	880 WK Lexan 1/4" Fixing Bracket
Qty	Part Number	Rev	Description
Parts List			

 Tél: (450) 979-4373 Fax: (450) 979-4626 www.exmweb.com		Flatness Aplatissement Max 3.0mm Projection 
Customer Client	Date	
Drawn By Dessiné Par	BoxCad: BoxCad	Date 09-Jan-25
Material Matière	16 Ga Cold Rolled A1008 CS Type B (1.4mm)	
Color Couleur	Light Grey RAL7035	Finish Fini Textured
Description		Detail Rev.
6412ESCHWTB 600mm x 300mm Cover		
Part Number Numéro Pièce	Rev.	9
6412ESCHWTB603012C	0	9