

This drawing is confidential and must not be reproduced or used without the consent of EXM

Ce dessin est confidentiel et ne doit pas être reproduit ou utilisé sans le consentement de EXM

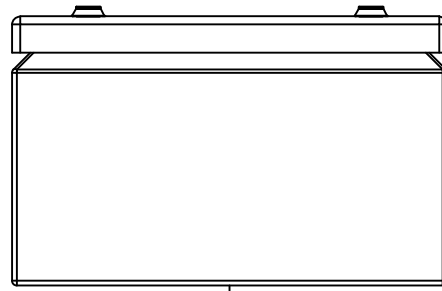

TOP

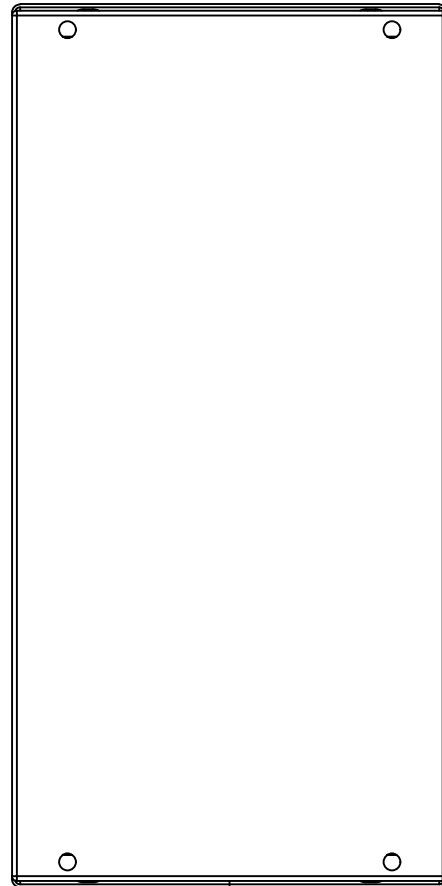

BACK

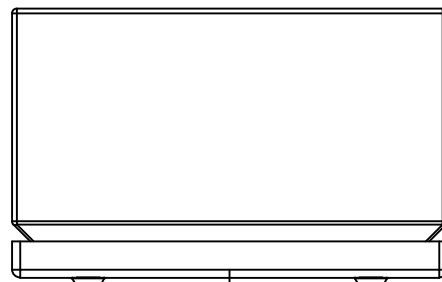

BOTTOM

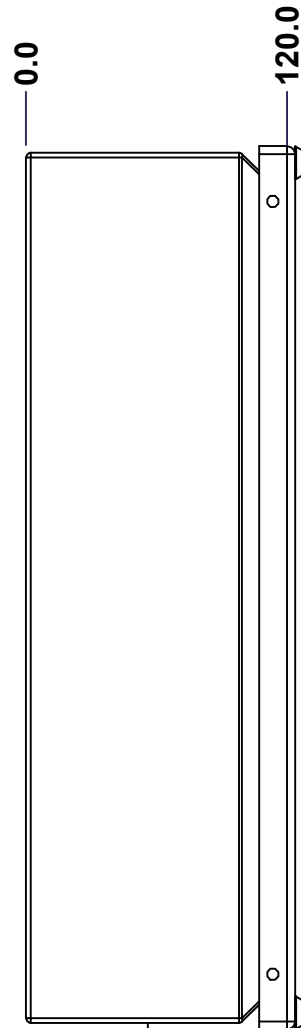

LEFT

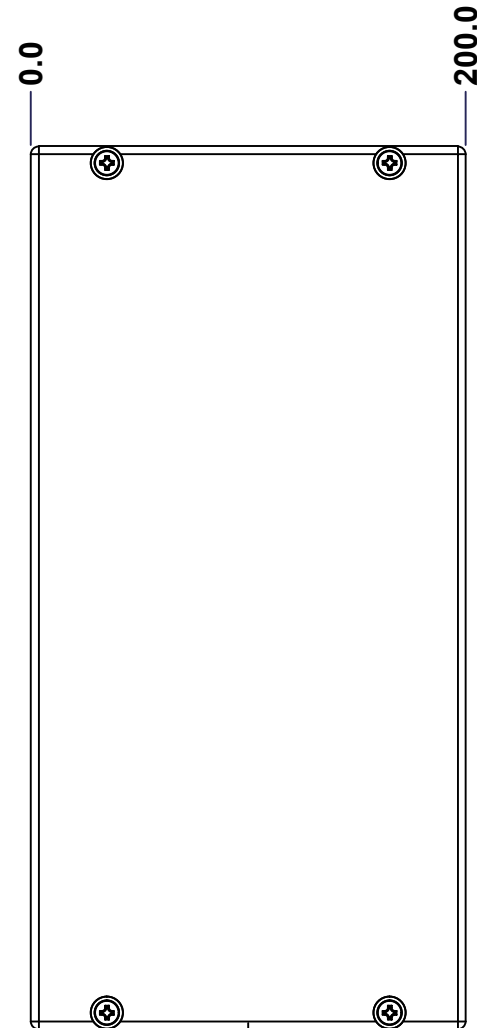

FRONT

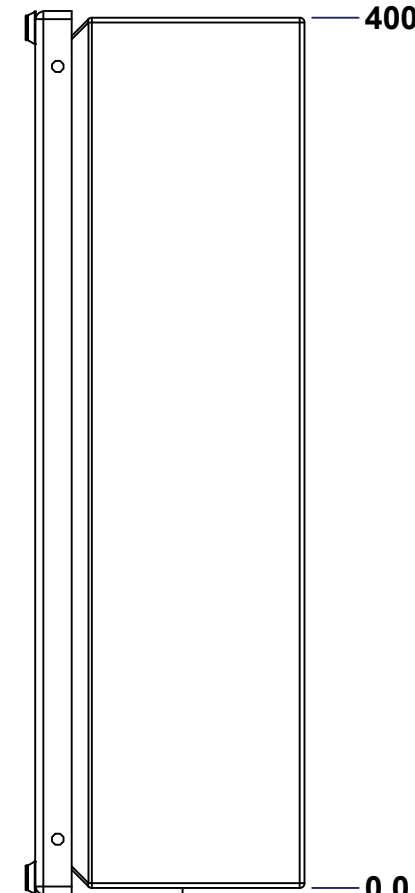

RIGHT

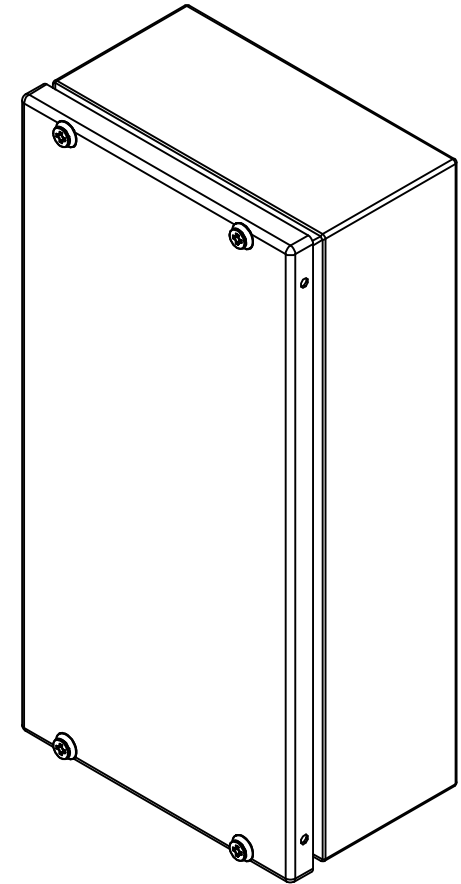

Isometric View

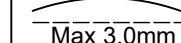

No.	Revisions	Date	By/Par

 Tél: (450) 979-4373 Fax: (450) 979-4626 <a href="http://www.exmweb.com">www.exmweb.com</a>		Flatness Aplatissement  Max 3.0mm
Customer Client		Date
Drawn By Dessiné Par BoxCad: boxcadcad-03_EN		Date 11-Dec-24
Material Matière 16 Ga Cold Rolled A1008 CS Type B (1.4mm)		
Color Couleur Light Grey RAL7035	Finish Fini Textured	
Description 6412ESTB 400mm x 200mm x 120mm Assembly		Detail Rev.
Part Number Numéro Pièce <b>6412ESTB402012</b>		Rev. <b>0</b>
SEE BILL OF MATERIAL ON LAST PAGE		1 9

This drawing is confidential and must not be reproduced or used without the consent of EXM

Ce dessin est confidentiel et ne doit pas être reproduit ou utilisé sans le consentement de EXM

NOTE	
ITEM	DESCRIPTION
1	NEMA 4, 12 Enclosure (IP66)
2	C/W Standard ground standoffs on box and cover
3	W/O Standard door stiffener
4	W/O Inner panel
5	C/W Standard inner panel mounting standoffs

No.	Revisions	Date	By/Par

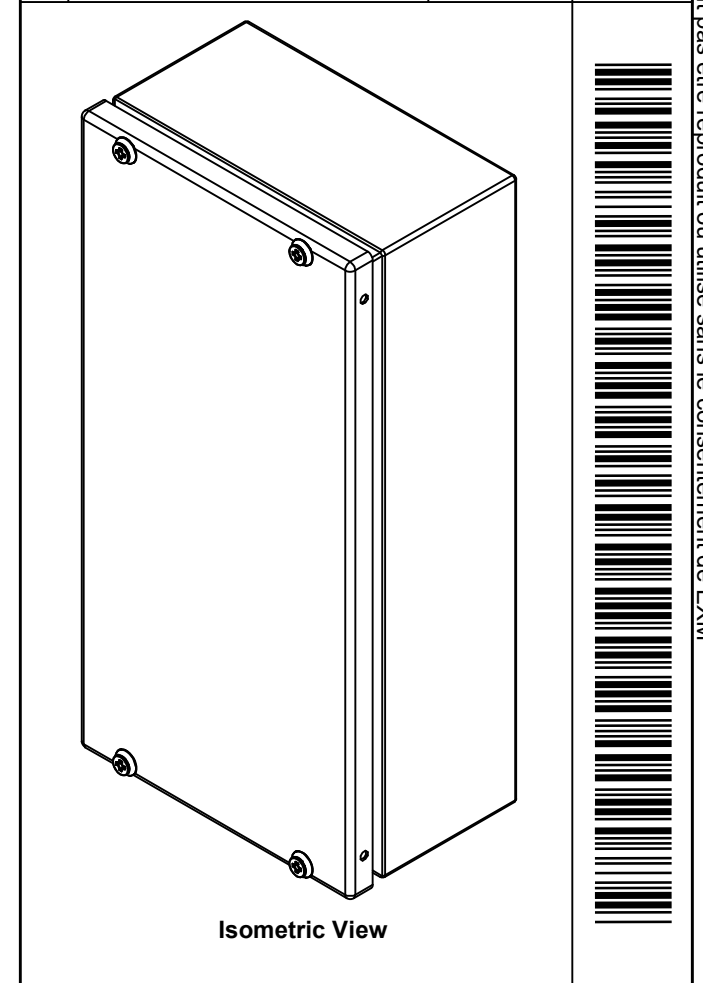

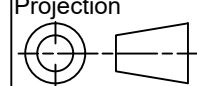
 Tél: (450) 979-4373 Fax: (450) 979-4626 <a href="http://www.exmweb.com">www.exmweb.com</a>		Flatness Aplatissement Max 3.0mm Projection 
Customer Client	Date	
Drawn By Dessiné Par	BoxCad: boxcadcad-03_EN	Date 11-Dec-24
Material Matière	16 Ga Cold Rolled A1008 CS Type B (1.4mm)	
Color Couleur	Light Grey RAL7035	Finish Fini Textured
Description 6412ESTB 400mm x 200mm x 120mm Assembly		Detail Rev.
Part Number Numéro Pièce	<b>6412ESTB402012</b>	Rev. 0

PACKING		
ITEM	QTY	DESCRIPTION
Cardboard sleeve	1	Top and Bottom
Cardboard strip	1	Between back of enclosure and inner panel
Plastic bag	1	To protect cover surface and inside gasket
Packaging label	1	White label with product number

Qty	Part Number	Rev	Description
1	6412ESTB402012C	0	6412ESTB 400mm x 200mm Cover
1	STK-K-02920	3	5412 ESSC Accessory Kit
2	6412ESTB402012BR-P	0	6412ESTB 400mm Bracket Part
1	6412ESTB402012B	0	6412ESTB 400mm x 200mm x 120mm Body
Parts List			

This drawing is confidential and must not be reproduced or used without the consent of EXM

Ce dessin est confidentiel et ne doit pas être reproduit ou utilisé sans le consentement de EXM

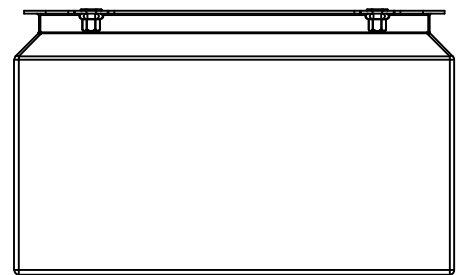

TOP

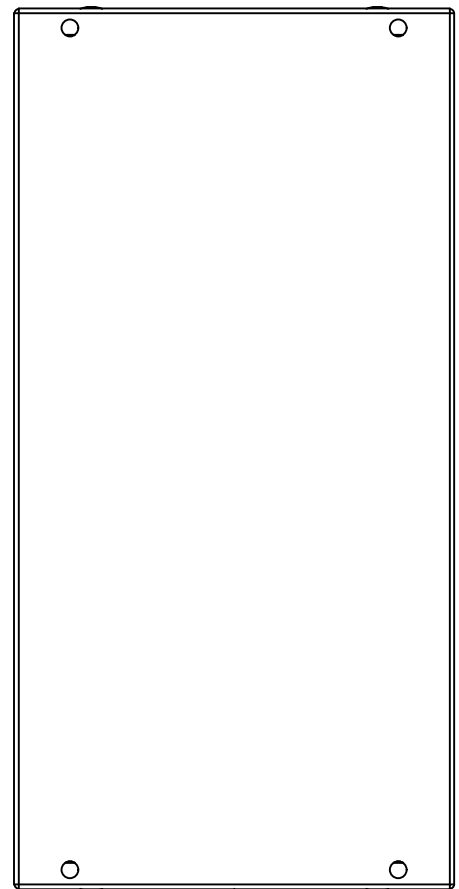

BACK

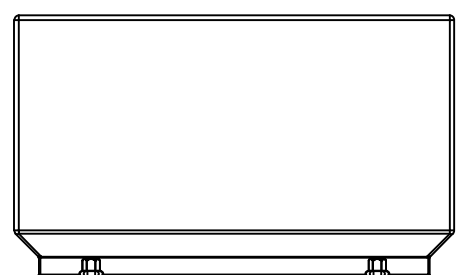

BOTTOM

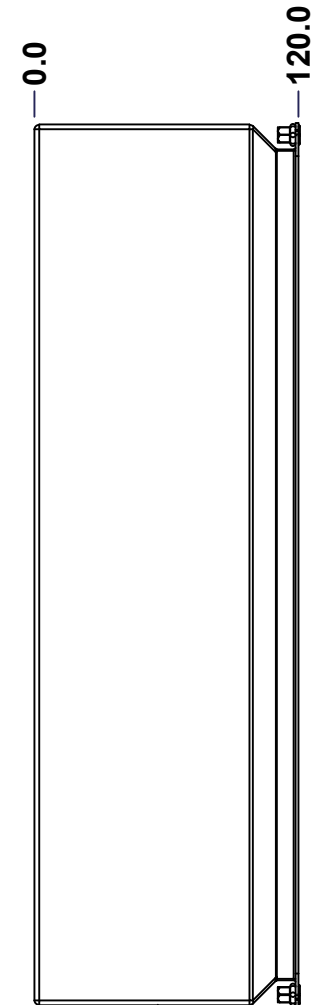

LEFT

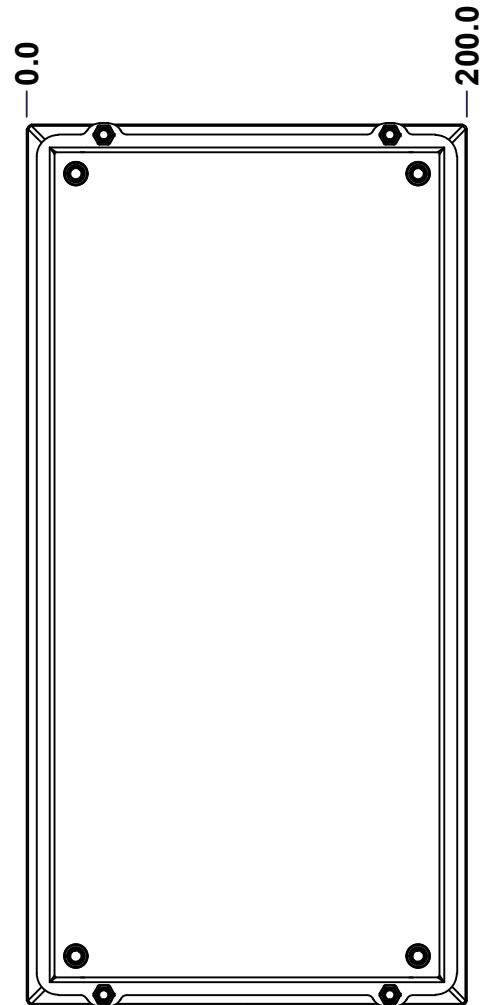

FRONT

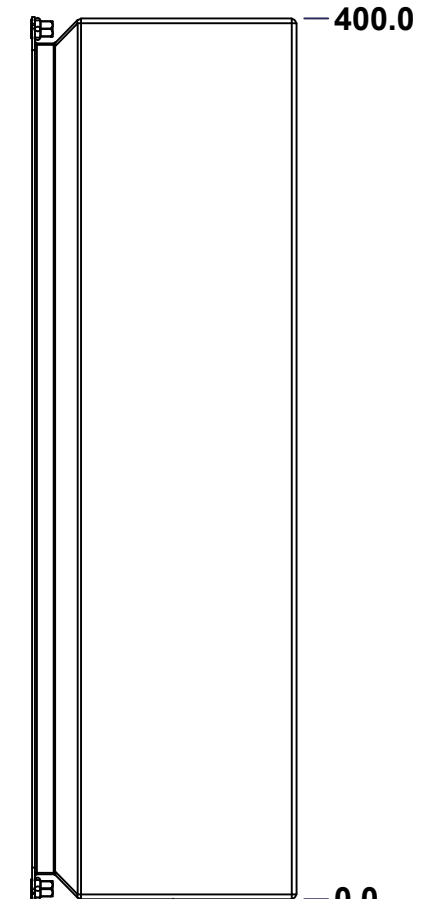

RIGHT

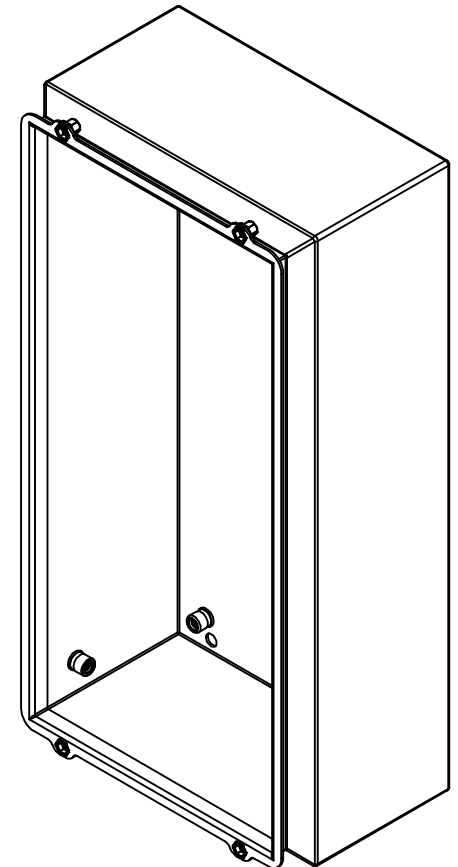

Isometric View

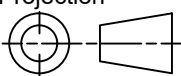

No.	Revisions	Date	By/Par

 Tél: (450) 979-4373 Fax: (450) 979-4626 <a href="http://www.exmweb.com">www.exmweb.com</a>		Flatness Aplatissement Max 3.0mm Projection 
Customer Client	Date	
Drawn By Dessiné Par	BoxCad: boxcadcad-03_EN	Date 11-Dec-24
Material Matière	16 Ga Cold Rolled A1008 CS Type B (1.4mm)	
Color Couleur	Light Grey RAL7035	Finish Fini Textured
Description	6412ESTB 400mm x 200mm x 120mm Body	
Part Number Numéro Pièce	6412ESTB402012B	Detail Rev. Rev. 3 0 9

SEE BILL OF MATERIAL ON LAST PAGE

This drawing is confidential and must not be reproduced or used without the consent of EXM

Ce dessin est confidentiel et ne doit pas être reproduit ou utilisé sans le consentement de EXM

**STANDARD FEATURES ARE NOT LISTED IN THIS HOLE TABLE**

**HOLE TABLE - LEFT VIEW (CUSTOM FEATURE ONLY)**

CUT-OUT	XDIM	YDIM	DESCRIPTION
1	77.2	22.2	STANDOFF M6 x 10mm (Inside)

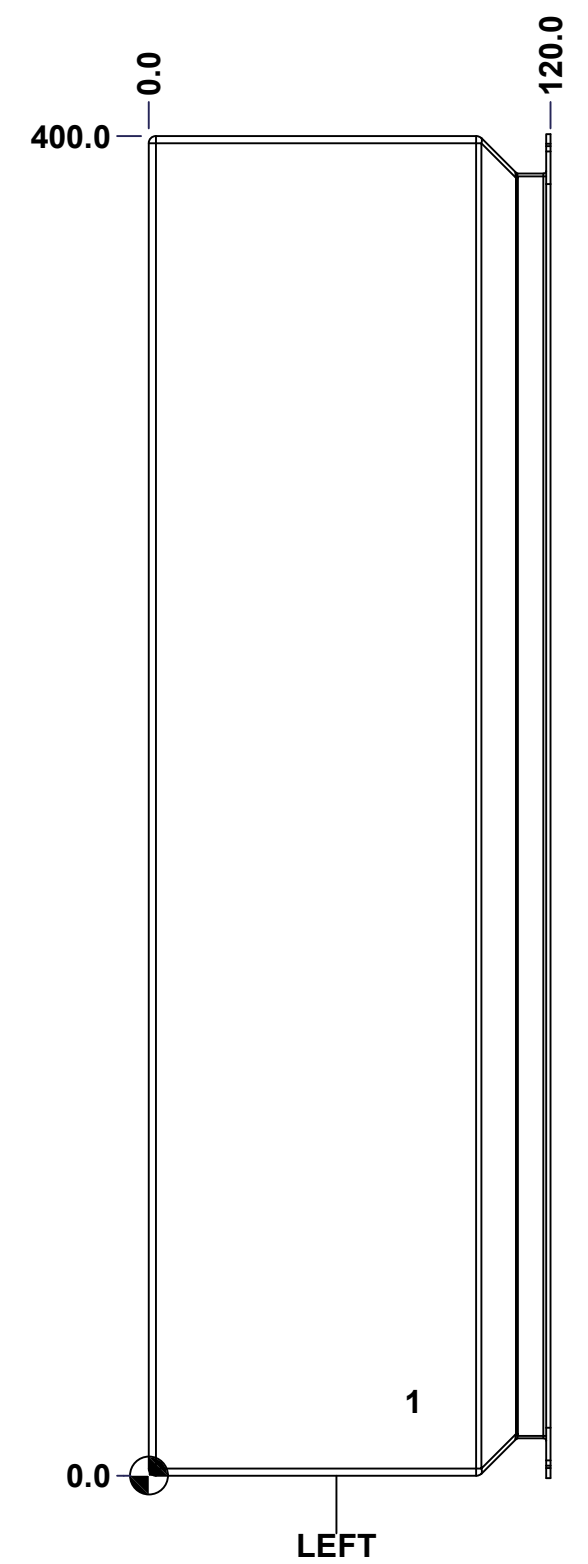

	Description 6412ESTB 400mm x 200mm x 120mm Body		Status (NULL)	
	Part Number Numéro Pièce <b>6412ESTB402012B</b>		Rev. <b>0</b>	4 9

This drawing is confidential and must not be reproduced or used without the consent of EXM

Ce dessin est confidentiel et ne doit pas être reproduit ou utilisé sans le consentement de EXM

**STANDARD FEATURES ARE NOT LISTED IN THIS HOLE TABLE**

**HOLE TABLE - BACK VIEW (CUSTOM FEATURE ONLY)**

CUT-OUT	XDIM	YDIM	DESCRIPTION
1	22.2	22.2	IP STANDOFF M6 x 10mm (Inside)
2	22.2	377.8	IP STANDOFF M6 x 10mm (Inside)
3	177.8	377.8	IP STANDOFF M6 x 10mm (Inside)
4	177.8	22.2	IP STANDOFF M6 x 10mm (Inside)

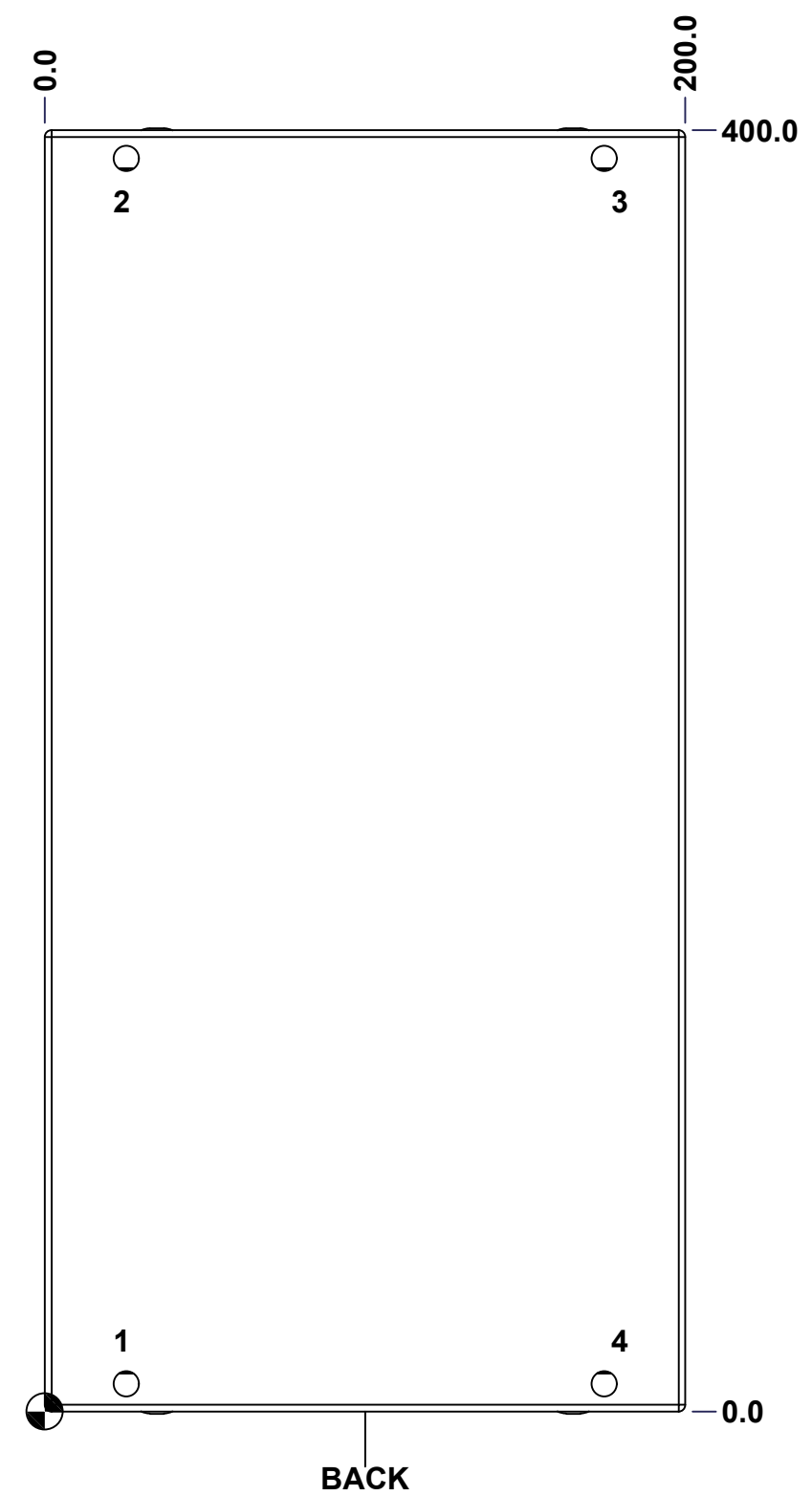

	Description 6412ESTB 400mm x 200mm x 120mm Body		Status (NULL)
	Part Number Numéro Pièce <b>6412ESTB402012B</b>		Rev. <b>0</b> / 5 9

This drawing is confidential and must not be reproduced or used without the consent of EXM

Ce dessin est confidentiel et ne doit pas être reproduit ou utilisé sans le consentement de EXM

No.	Revisions	Date	By/Par

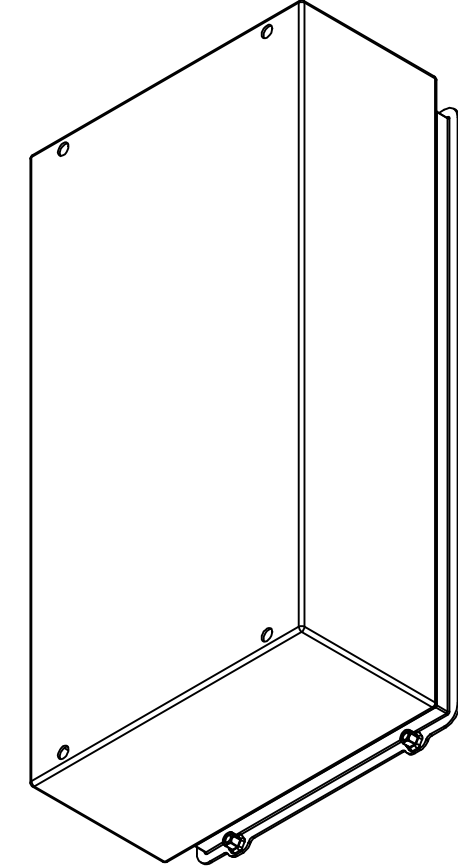

Isometric View

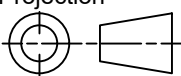

 Tél: (450) 979-4373 Fax: (450) 979-4626 <a href="http://www.exmweb.com">www.exmweb.com</a>	Flatness Aplatissement	Max 3.0mm
	Projection	
Customer Client	Date	
Drawn By Dessiné Par	BoxCad: boxcadcad-03_EN	Date 11-Dec-24
Material Matière	16 Ga Cold Rolled A1008 CS Type B (1.4mm)	
Color Couleur	Light Grey RAL7035	Finish Fini Textured
Description	6412ESTB 400mm x 200mm x 120mm Body	
Part Number Numéro Pièce	6412ESTB402012B	Detail Rev. Rev. 6
		9

Qty	Part Number	Rev	Description
1	STK-P-03820R	0	Powder Paint (Light Grey / Rough Textured)
4	RIVET_NUT_M5_FH_OE	0	Rivet Nut M5 (Low Profile Open End)
1	6412ESTB402012B-P	0	6412ESTB 400mm x 200mm x 112.1mm Body Part
5	STK-Q-08350	5	Standoff M6 x 10mm
Parts List			

This drawing is confidential and must not be reproduced or used without the consent of EXM

Ce dessin est confidentiel et ne doit pas être reproduit ou utilisé sans le consentement de EXM

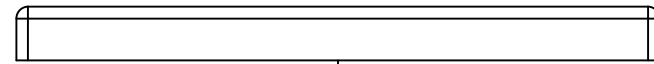

TOP

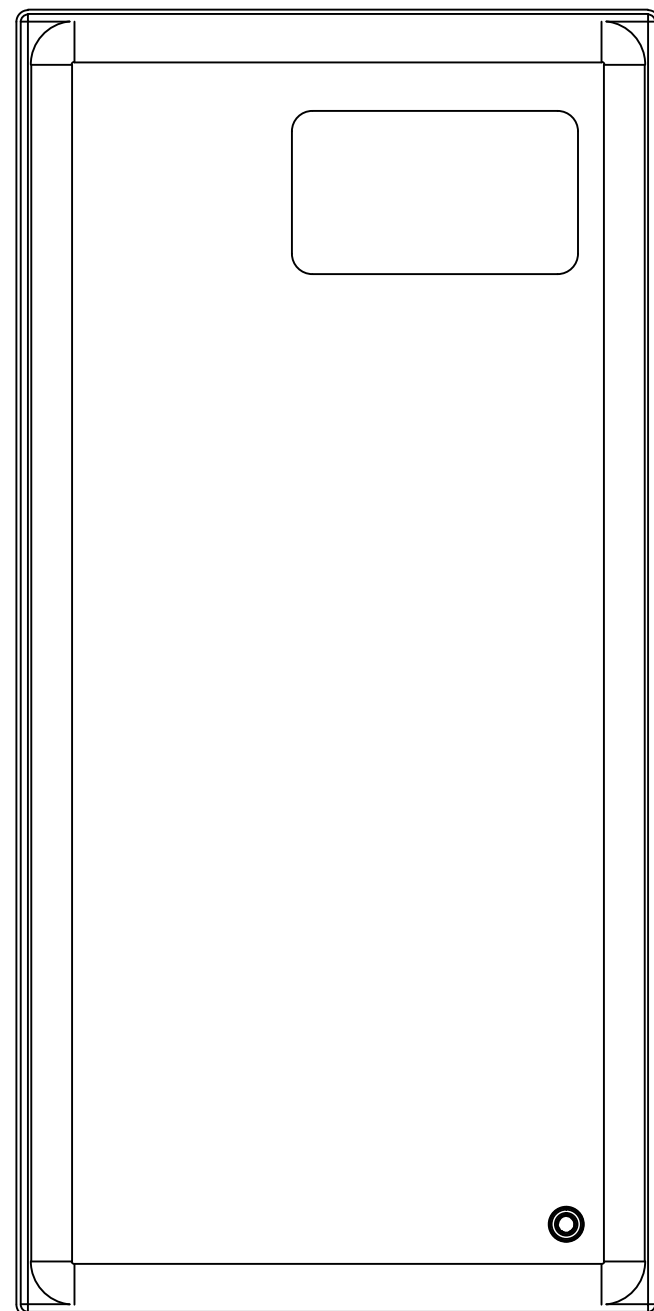

BACK

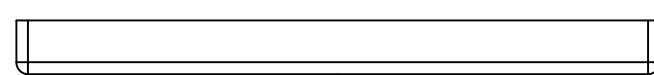

BOTTOM

0.0  
16.7



LEFT

0.0  
200.0

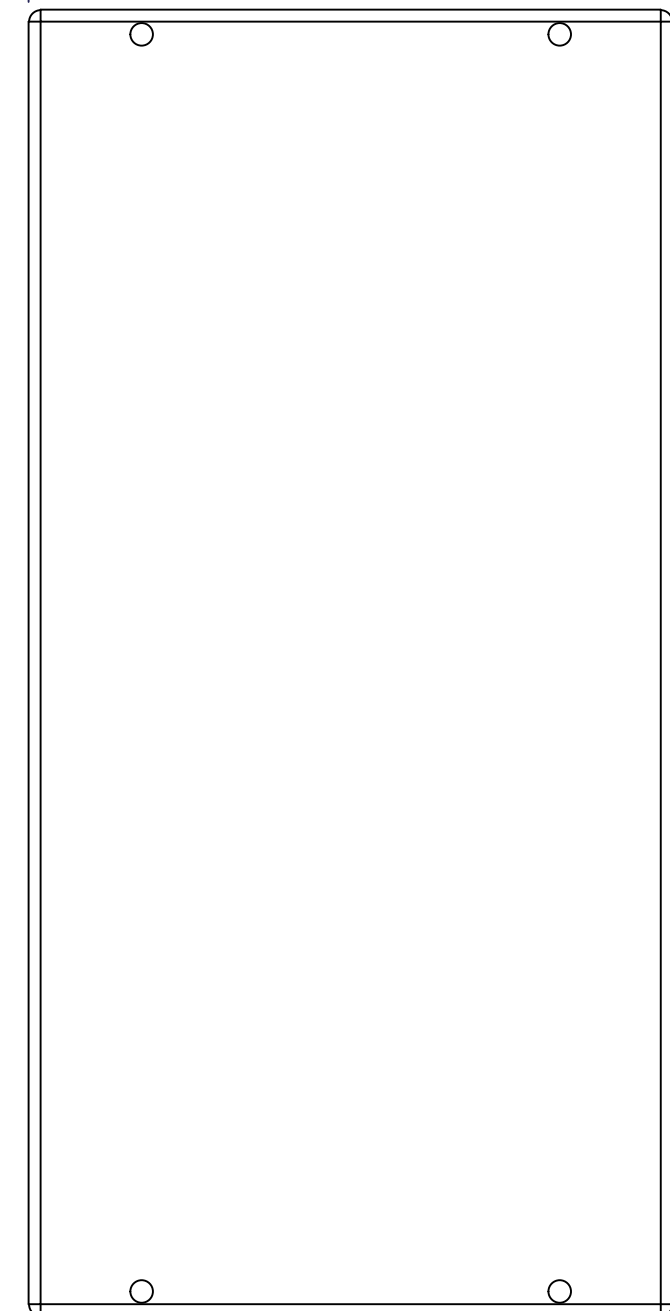

FRONT

406.0

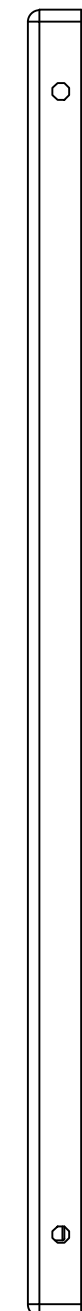

RIGHT

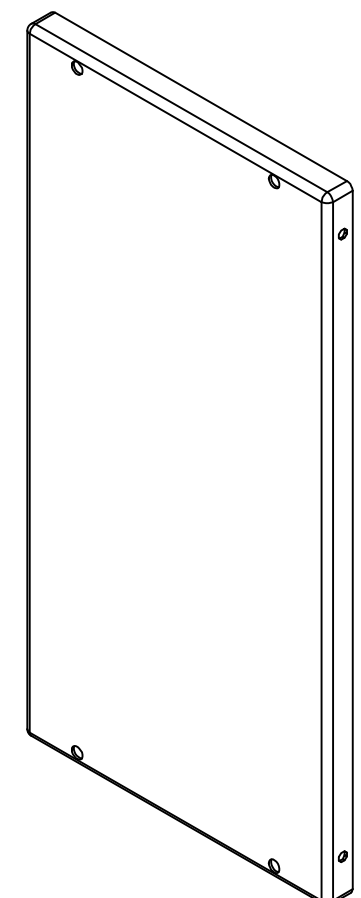

Isometric View

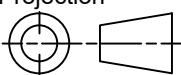

No.	Revisions	Date	By/Par

 Tél: (450) 979-4373 Fax: (450) 979-4626 <a href="http://www.exmweb.com">www.exmweb.com</a>		Flatness Aplatissement Max 3.0mm Projection 
Customer Client	Date	
Drawn By Dessiné Par	BoxCad: boxcadcad-03_EN	Date 11-Dec-24
Material Matière	16 Ga Cold Rolled A1008 CS Type B (1.4mm)	
Color Couleur	Light Grey RAL7035	Finish Fini Textured
Description	Detail Rev.	
6412ESTB 400mm x 200mm Cover		
Part Number Numéro Pièce	Rev. 0	7 9

SEE BILL OF MATERIAL ON LAST PAGE

**6412ESTB402012C**

This drawing is confidential and must not be reproduced or used without the consent of EXM

Ce dessin est confidentiel et ne doit pas être reproduit ou utilisé sans le consentement de EXM

STANDARD FEATURES ARE NOT LISTED IN THIS HOLE TABLE			
HOLE TABLE - FRONT VIEW (CUSTOM FEATURE ONLY)			
CUT-OUT	XDIM	YDIM	DESCRIPTION
1	29.1	28.6	STANDOFF M6 x 10mm (Inside)
2	69.9	349.2	LABEL_EXM (Inside)

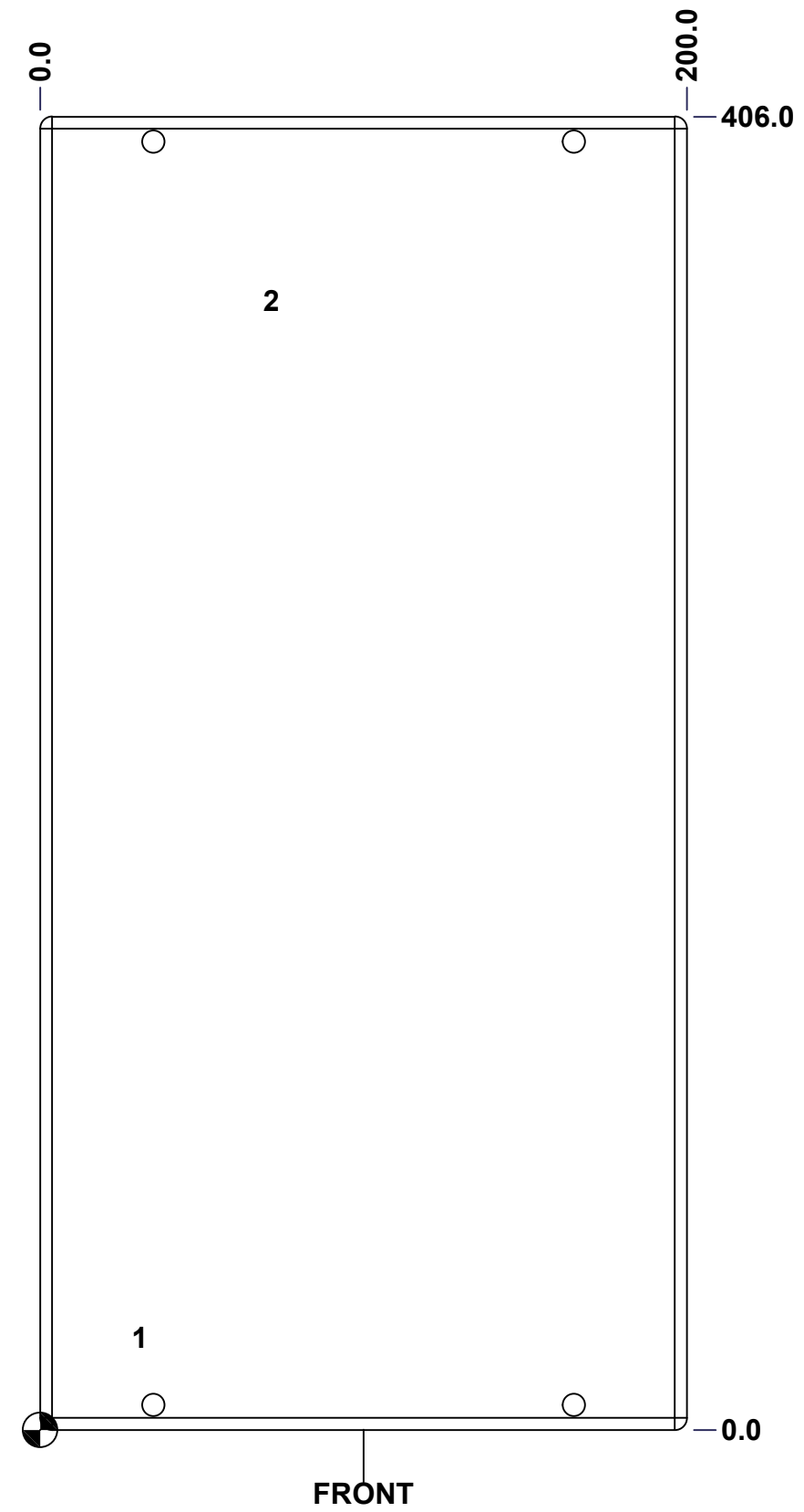

	Description	Status
	6412ESTB 400mm x 200mm Cover	(NULL)
Part Number Numéro Pièce <b>6412ESTB402012C</b>	Rev.	8
	<b>0</b>	9

This drawing is confidential and must not be reproduced or used without the consent of EXM

Ce dessin est confidentiel et ne doit pas être reproduit ou utilisé sans le consentement de EXM

No.	Revisions	Date	By/Par

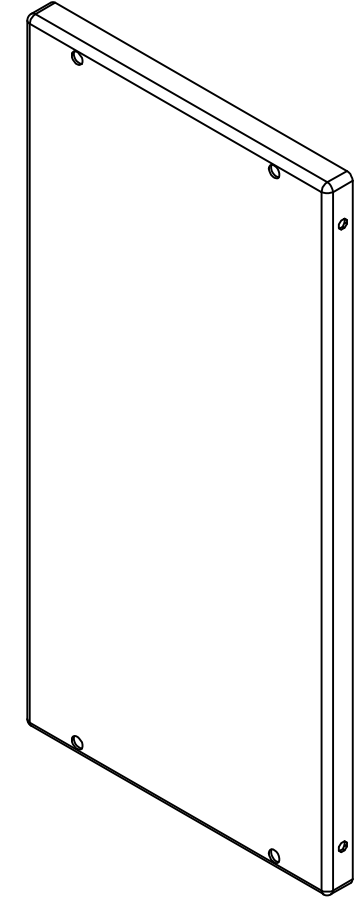

Isometric View

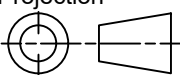

 Tél: (450) 979-4373 Fax: (450) 979-4626 <a href="http://www.exmweb.com">www.exmweb.com</a>		Flatness Aplatissement Max 3.0mm
Customer Client		Projection 
Drawn By / Dessiné Par: BoxCad: boxcadcad-03_EN		Date: 11-Dec-24
Material / Matière: 16 Ga Cold Rolled A1008 CS Type B (1.4mm)		
Color / Couleur: Light Grey RAL7035	Finish / Fini: Textured	
Description: 6412ESTB 400mm x 200mm Cover		Detail Rev.
Part Number / Numéro Pièce: <b>6412ESTB402012C</b>		Rev. 0 / 9

QTY	Part Number	Rev	Description
1	STK-S-00100	0	3.5" x 2" Silver Milar Flexcon Sticker
1	STK-Q-08350	5	Standoff M6 x 10mm
1	STK-P-03820R	0	Powder Paint (Light Grey / Rough Textured)
1	6412ESTB402012G	0	6412ESTB 400mm x 200mm Gasket
1	6412ESTB402012C-P	0	6412ESTB 400mm x 200mm Cover Part
Parts List			