

This drawing is confidential and must not be reproduced or used without the consent of EXM

Ce dessin est confidentiel et ne doit pas être reproduit ou utilisé sans le consentement de EXM

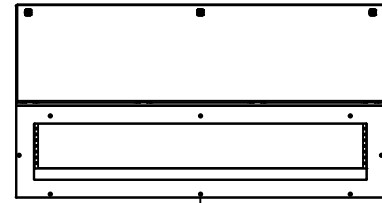

TOP

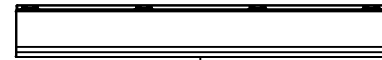

BACK

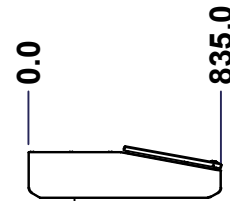

LEFT

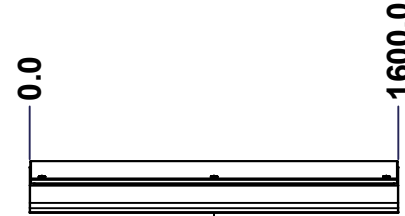

FRONT

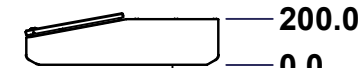

RIGHT

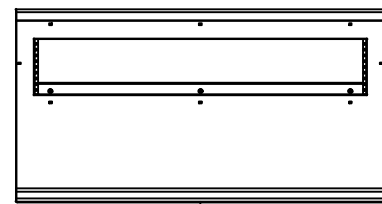

BOTTOM

No.	Revisions	Date	By/Par

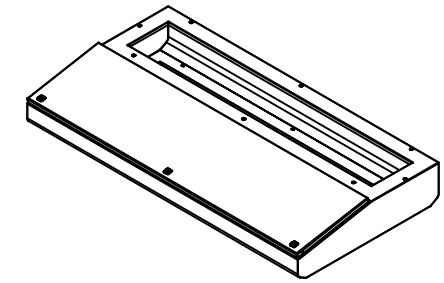

Isometric View



Tél: (450) 979-4373
 Fax: (450) 979-4626
www.exmweb.com

Flatness
Aplatissement

Max 3.0mm

Projection

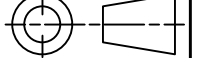

Customer Client	Date
Drawn By Dessiné Par BoxCad: BoxCad	Date 05-Aug-15
Material Matière 14 Ga Cold Rolled A1008 CS Type B (1.7mm)	
Color Couleur Light Grey RAL7035	Finish Fini Textured
Description 6500MWDFD 200mm x 1600mm x 400mm Assembly	Detail Rev.
Part Number Numéro Pièce 6500MWDFD1604	Rev. 1 0 / 10

SEE BILL OF MATERIAL ON LAST PAGE

This drawing is confidential and must not be reproduced or used without the consent of EXM

Ce dessin est confidentiel et ne doit pas être reproduit ou utilisé sans le consentement de EXM

NOTE	
ITEM	DESCRIPTION
1	NEMA 12, 13 Enclosure (IP55)
2	C/W Standard ground studs on box and cover
3	W/O Inner panel
4	C/W Standard inner panel mounting studs

No.	Revisions	Date	By/Par

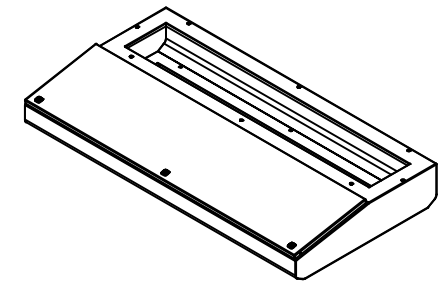

Isometric View



Tél: (450) 979-4373
 Fax: (450) 979-4626
www.exmweb.com



Customer Client	Date
Drawn By / Dessiné Par: BoxCad: BoxCad	Date: 05-Aug-15

Material / Matière: 14 Ga Cold Rolled A1008 CS Type B (1.7mm)

Color / Couleur: Light Grey RAL7035 Finish / Fini: Textured

Description: 6500MWDFD 200mm x 1600mm x 400mm Assembly

Part Number / Numéro Pièce: **6500MWDFD1604** Rev. 0 2/10

PACKING		
ITEM	QTY	DESCRIPTION
Cardboard corner	2	To reinforced for the plastic strap tightening
Honeycomb angle	4	To protect each corners
Plastic strap- Green	2	To secure the enclosure to the wood pallet
Wood pallet	1	Standard wood pallet
Flat cardboard	1	Between the enclosure and the wood pallet
Packaging label	1	White label with product number

Qty	Part Number	Rev	Description
1	6500MWDFD1604TD	0	6500MWDFD 1600mm x 400mm Top Cover
1	6500MWDFD1604B	0	6500MWDFD 200mm x 1600mm x 400mm Body
2	880 GS115	1	Gas Spring 115N/12Kg/26Lbs
4	STK-Q-04050-07	7	M6 x 7mm Hexagon Socket Head Machine Screw with Nyseal

Parts List

This drawing is confidential and must not be reproduced or used without the consent of EXM

Ce dessin est confidentiel et ne doit pas être reproduit ou utilisé sans le consentement de EXM

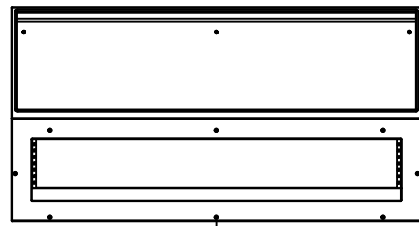

TOP

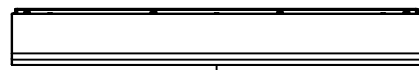

BACK

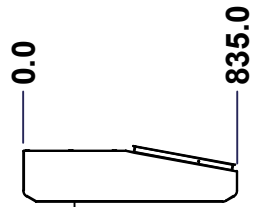

LEFT

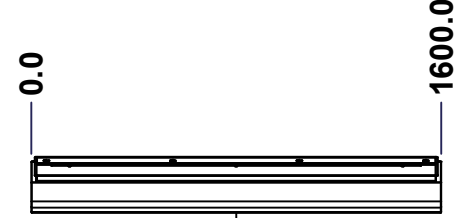

FRONT

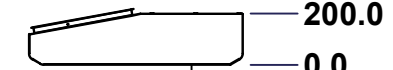

RIGHT

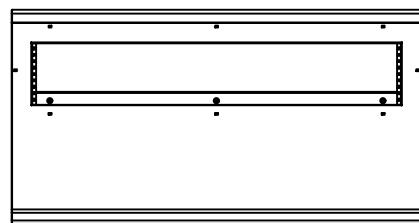

BOTTOM

No.	Revisions	Date	By/Par

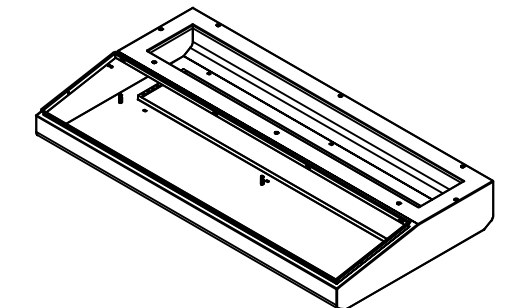

Isometric View

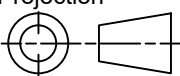

 Tél: (450) 979-4373 Fax: (450) 979-4626 www.exmweb.com		Flatness Aplatissement Max 3.0mm Projection 
Customer Client	Date	
Drawn By Dessiné Par	BoxCad: BoxCad	Date 05-Aug-15
Material Matière	14 Ga Cold Rolled A1008 CS Type B (1.7mm)	
Color Couleur	Light Grey RAL7035	Finish Fini Textured
Description	Detail Rev.	
6500MWDFD 200mm x 1600mm x 400mm Body		
Part Number Numéro Pièce	Rev.	3
6500MWDFD1604B	0	10

SEE BILL OF MATERIAL ON LAST PAGE

This drawing is confidential and must not be reproduced or used without the consent of EXM

Ce dessin est confidentiel et ne doit pas être reproduit ou utilisé sans le consentement de EXM

STANDARD FEATURES ARE NOT LISTED IN THIS HOLE TABLE			
HOLE TABLE - RIGHT VIEW (CUSTOM FEATURE ONLY)			
CUT-OUT	XDIM	YDIM	DESCRIPTION
1	450.0	160.0	GND STUD M6 x 16mm (Inside)

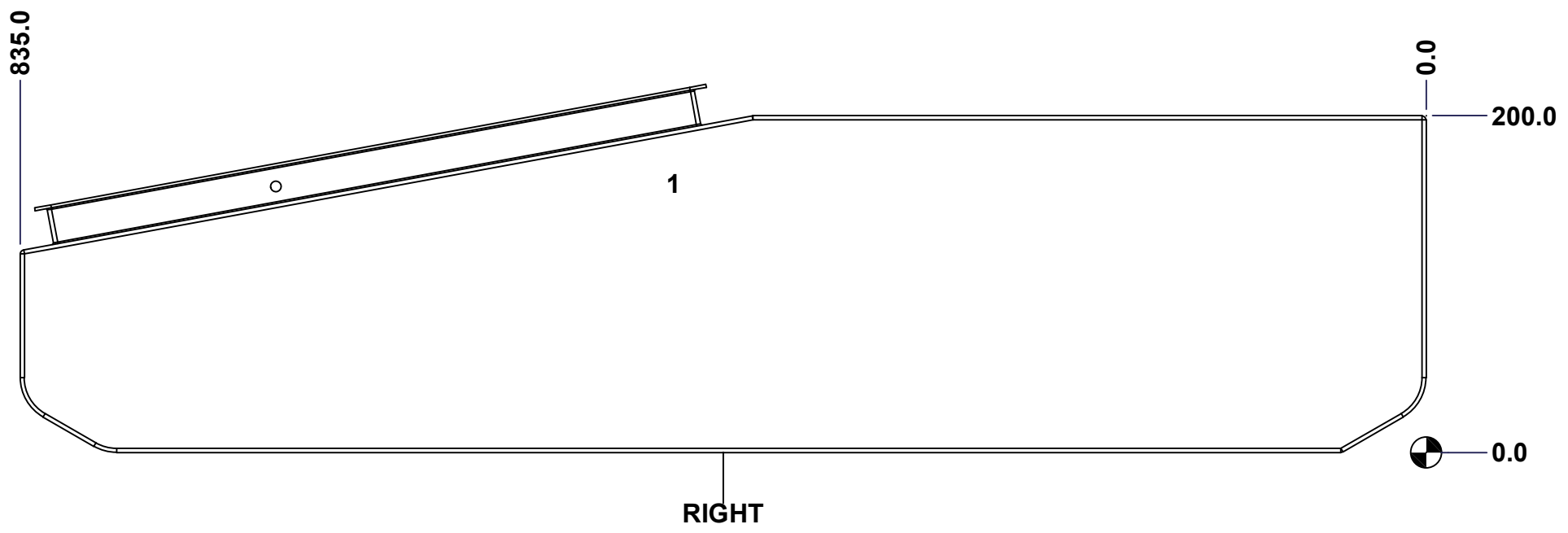

	Description 6500MWDFD 200mm x 1600mm x 400mm Body		Status (NULL)
	Part Number Numéro Pièce 6500MWDFD1604B		Rev. 4 0 / 10

This drawing is confidential and must not be reproduced or used without the consent of EXM

Ce dessin est confidentiel et ne doit pas être reproduit ou utilisé sans le consentement de EXM

STANDARD FEATURES ARE NOT LISTED IN THIS HOLE TABLE

HOLE TABLE - BOTTOM VIEW (CUSTOM FEATURE ONLY)

CUT-OUT	XDIM	YDIM	DESCRIPTION
1	47.5	97.5	IP STUD M8 x 35mm (Inside)
2	1552.5	97.5	IP STUD M8 x 35mm (Inside)
3	47.5	402.5	IP STUD M8 x 35mm (Inside)
4	1552.5	402.5	IP STUD M8 x 35mm (Inside)
5	800.0	97.5	IP STUD M8 x 35mm (Inside)
6	800.0	402.5	IP STUD M8 x 35mm (Inside)

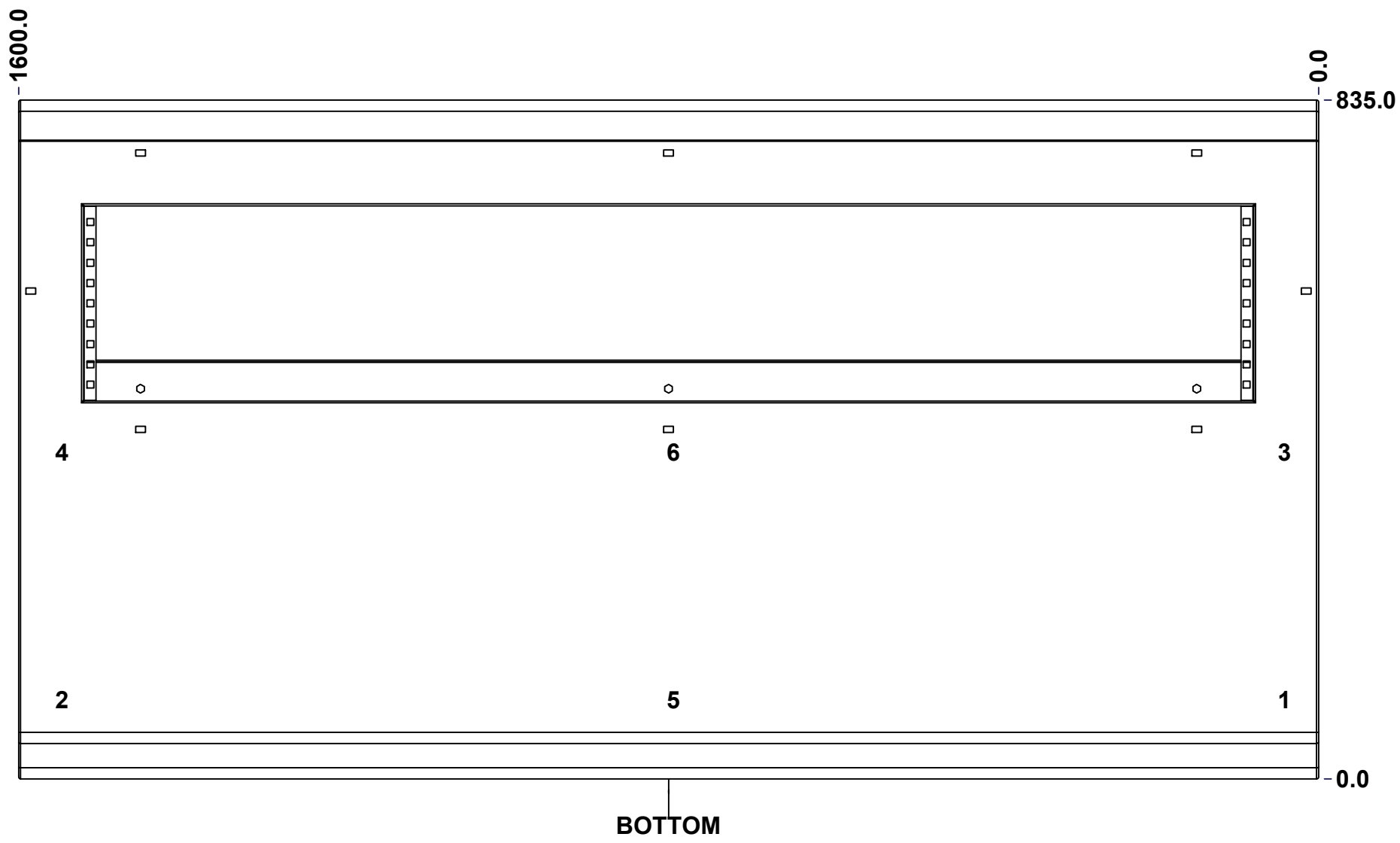

	Description 6500MWDFD 200mm x 1600mm x 400mm Body		Status (NULL)
	Part Number Numéro Pièce 6500MWDFD1604B		Rev. 5 0 / 10

This drawing is confidential and must not be reproduced or used without the consent of EXM

Ce dessin est confidentiel et ne doit pas être reproduit ou utilisé sans le consentement de EXM

STANDARD FEATURES ARE NOT LISTED IN THIS HOLE TABLE			
HOLE TABLE - LEFT VIEW (CUSTOM FEATURE ONLY)			
CUT-OUT	XDIM	YDIM	DESCRIPTION
1	450.0	160.0	GND STUD M6 x 16mm (Inside)

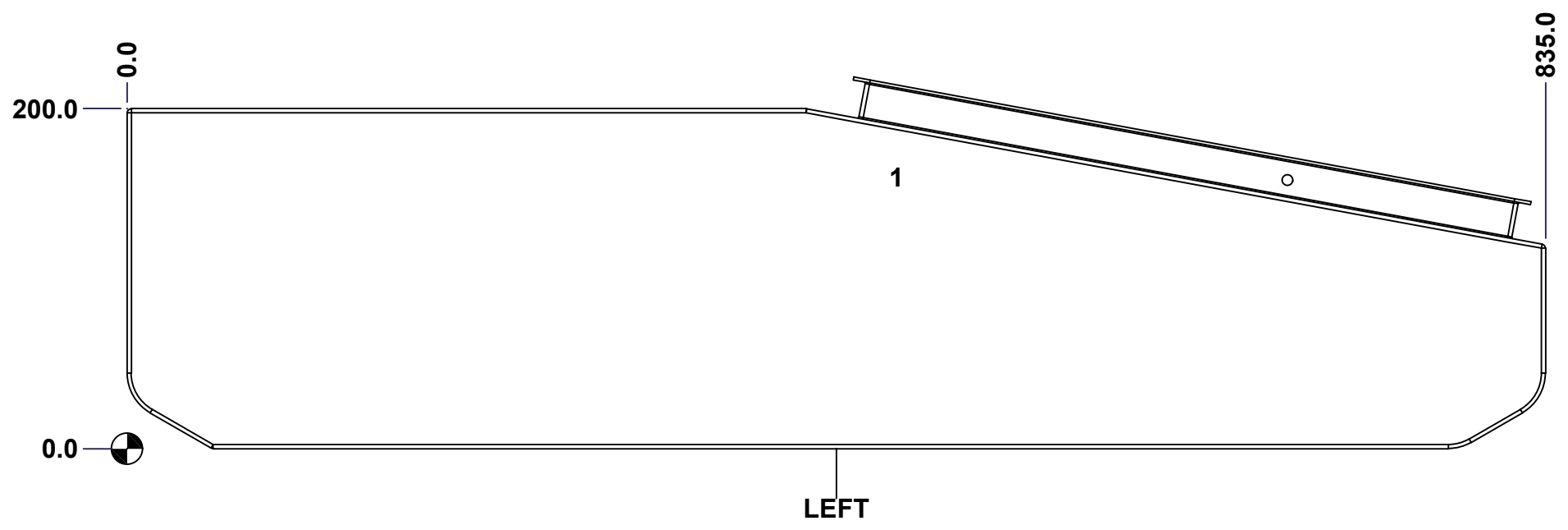

	Description 6500MWDFD 200mm x 1600mm x 400mm Body	Status (NULL)
	Part Number Numéro Pièce 6500MWDFD1604B	Rev. 6 0 / 10

This drawing is confidential and must not be reproduced or used without the consent of EXM

Ce dessin est confidentiel et ne doit pas être reproduit ou utilisé sans le consentement de EXM

No.	Revisions	Date	By/Par

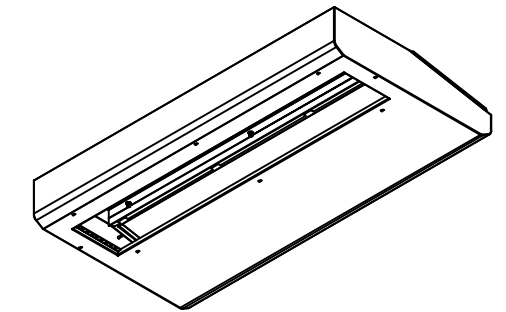

Isometric View

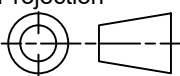

 Tél: (450) 979-4373 Fax: (450) 979-4626 www.exmweb.com	Flatness Aplatissement	Max 3.0mm
	Projection	
Customer Client	Date	
Drawn By Dessiné Par	BoxCad: BoxCad	Date 05-Aug-15
Material Matière	14 Ga Cold Rolled A1008 CS Type B (1.7mm)	
Color Couleur	Light Grey RAL7035	Finish Fini Textured
Description	6500MWDFD 200mm x 1600mm x 400mm Body	Detail Rev.
Part Number Numéro Pièce	6500MWDFD1604B	Rev. 7 0 10

Qty	Part Number	Rev	Description
8	RIVET_NUT_M6_FH_CE	0	Rivet Nut M6 (Low Profile Close End)
2	STK-Q-16080	0	Ground Stud M6 x 16mm Steel
1	STK-P-03820R	0	Powder Paint (Light Grey / Rough Textured)
6	STK-Q-16005	0	Stud M8 x 35mm Steel
1	6500MWDFD1604CPS-P	0	6500MWDFD 1600mm Center Post Stiffener Part
1	6500MWDFD1604B-P	0	6500MWDFD 200mm x 1600mm x 400mm Body Part
Parts List			

This drawing is confidential and must not be reproduced or used without the consent of EXM

Ce dessin est confidentiel et ne doit pas être reproduit ou utilisé sans le consentement de EXM

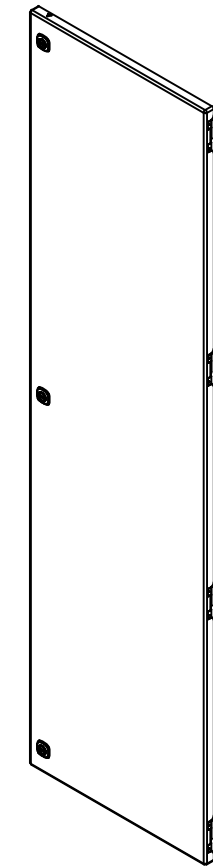
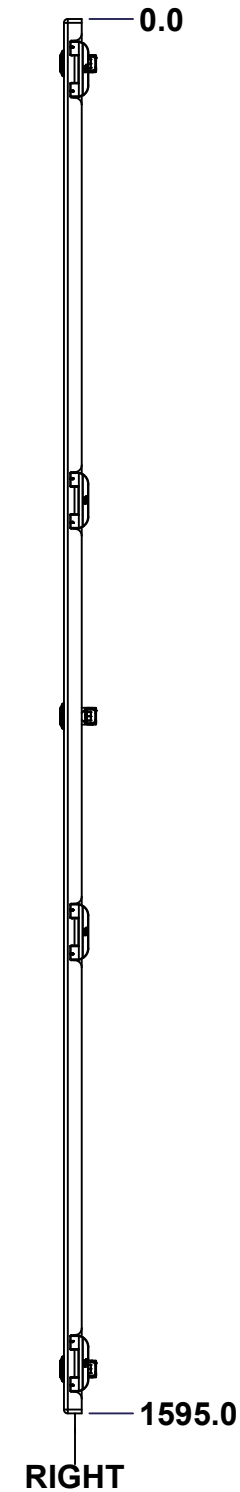
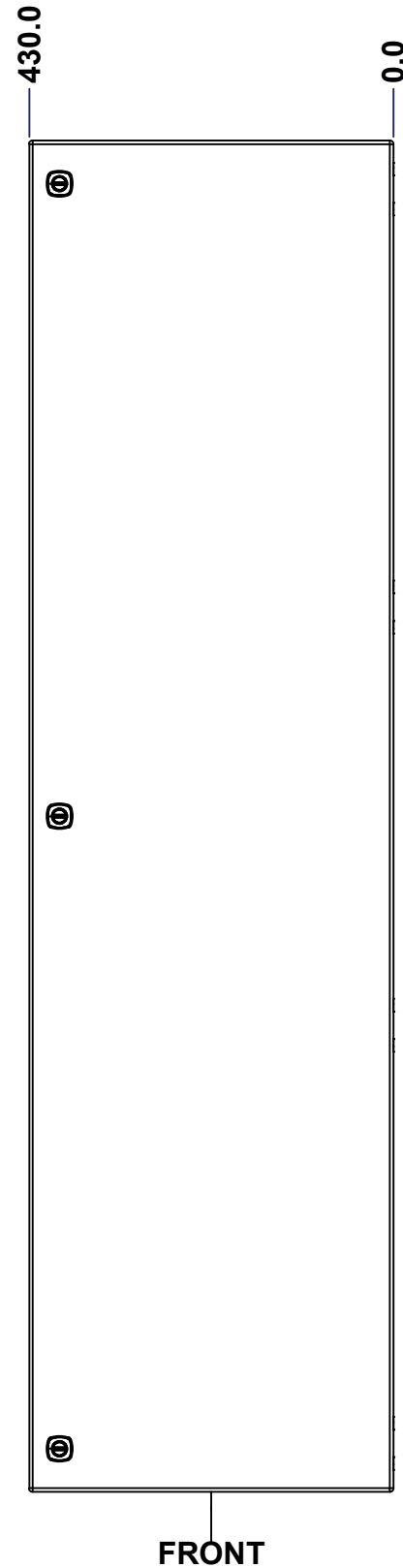
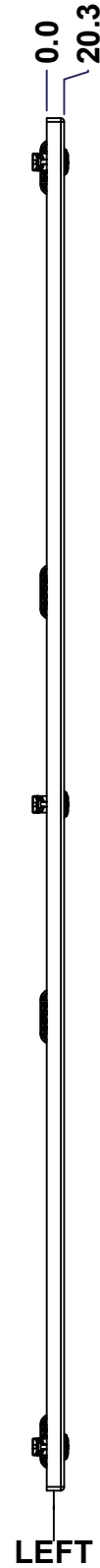
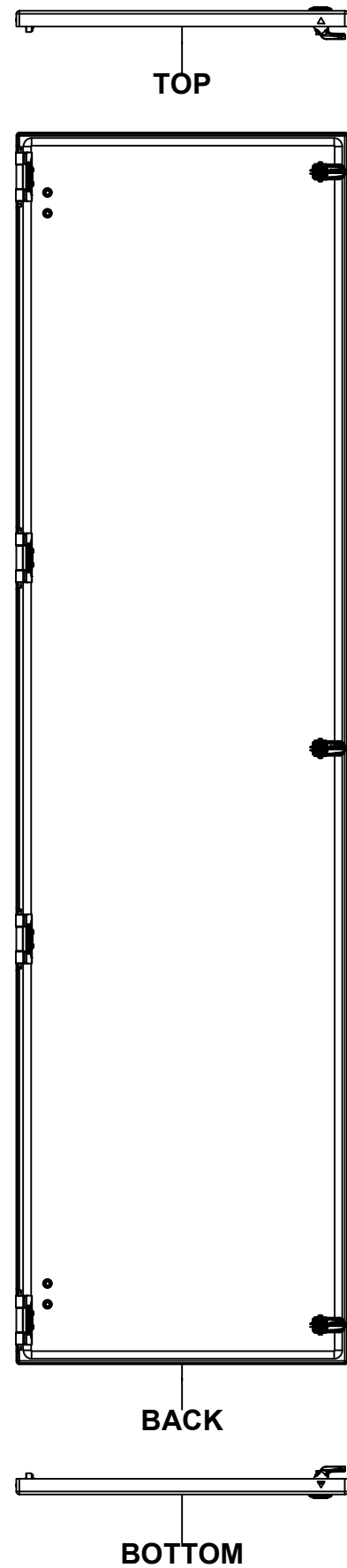

Isometric View

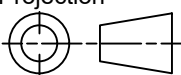

No.	Revisions	Date	By/Par

 Tél: (450) 979-4373 Fax: (450) 979-4626 www.exmweb.com		Flatness Aplatissement Max 3.0mm Projection 
Customer Client	Date	
Drawn By Dessiné Par	BoxCad: BoxCad	Date 05-Aug-15
Material Matière	14 Ga Cold Rolled A1008 CS Type B (1.7mm)	
Color Couleur	Light Grey RAL7035	Finish Fini Textured
Description		Detail Rev.
6500MWDFD 1600mm x 400mmTop Cover		
Part Number Numéro Pièce	Rev.	8
6500MWDFD1604TD	0	10

SEE BILL OF MATERIAL ON LAST PAGE

This drawing is confidential and must not be reproduced or used without the consent of EXM

Ce dessin est confidentiel et ne doit pas être reproduit ou utilisé sans le consentement de EXM

STANDARD FEATURES ARE NOT LISTED IN THIS HOLE TABLE

HOLE TABLE - FRONT VIEW (CUSTOM FEATURE ONLY)

CUT-OUT	XDIM	YDIM	DESCRIPTION
1	394.1	50.8	LOCK 880 SCQ4-SL @ 270.0°
2	394.1	797.5	LOCK 880 SCQ4-SL @ 270.0°
3	394.1	1544.2	LOCK 880 SCQ4-SL @ 270.0°
4	40.6	77.6	STANDOFF M6 x 10mm (Inside)
5	40.6	104.4	STANDOFF M6 x 10mm (Inside)
6	40.6	1517.4	STANDOFF M6 x 10mm (Inside)
7	40.6	1490.6	STANDOFF M6 x 10mm (Inside)

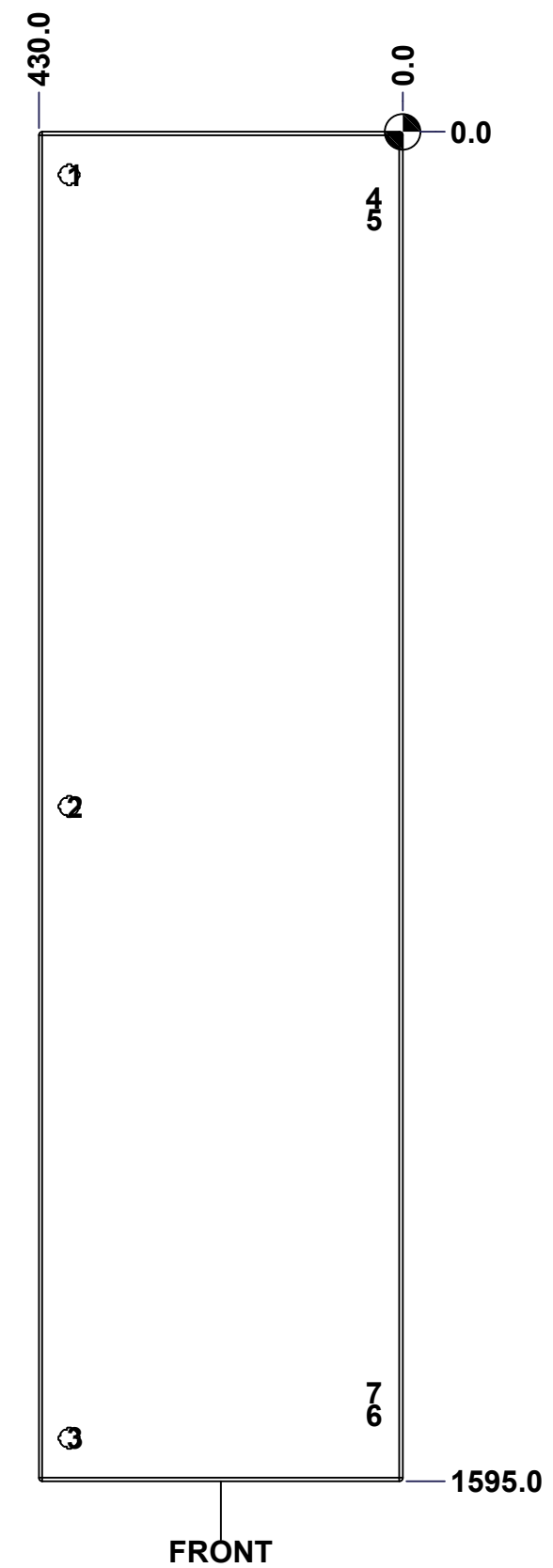

FRONT

	Description 6500MWDFD 1600mm x 400mm Top Cover	Status (NULL)
	Part Number Numéro Pièce 6500MWDFD1604TD	Rev. 9 0

This drawing is confidential and must not be reproduced or used without the consent of EXM

Ce dessin est confidentiel et ne doit pas être reproduit ou utilisé sans le consentement de EXM

No.	Revisions	Date	By/Par

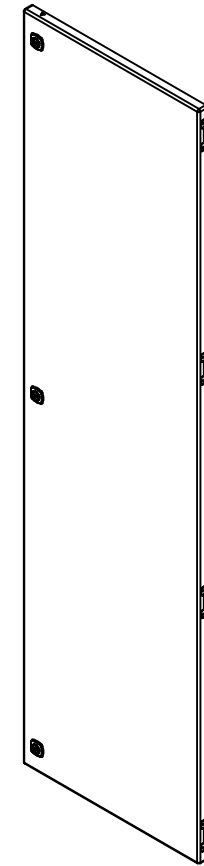

Isometric View

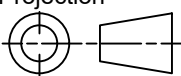

 Tél: (450) 979-4373 Fax: (450) 979-4626 www.exmweb.com	Flatness Aplatissement	Max 3.0mm
	Projection	
Customer Client	Date	
Drawn By Dessiné Par	BoxCad: BoxCad	Date 05-Aug-15
Material Matière	14 Ga Cold Rolled A1008 CS Type B (1.7mm)	
Color Couleur	Light Grey RAL7035	Finish Fini Textured
Description	Detail Rev.	
6500MWDFD 1600mm x 400mm Top Cover		
Part Number Numéro Pièce	Rev.	10
6500MWDFD1604TD	0	10

Qty	Part Number	Rev	Description
4	STK-Q-08350	5	Standoff M6 x 10mm
3	STK-K-12500	19	5412 ES 1/4 Turn Lock
1	STK-P-03820R	0	Powder Paint (Light Grey / Rough Textured)
1	6500MWDFD1604TD-P	0	6500MWDFD 1600mm x 400mm Top Cover Part
1	6500MWDFD1604TD-G	0	6500MWDFD 200mm x 1600mm Top Cover Gasket
4	STK-K-09800	10	5412 ES Hinge with 2 Captive Hinge Pins
Parts List			