

This drawing is confidential and must not be reproduced or used without the consent of EXM

Ce dessin est confidentiel et ne doit pas être reproduit ou utilisé sans le consentement de EXM

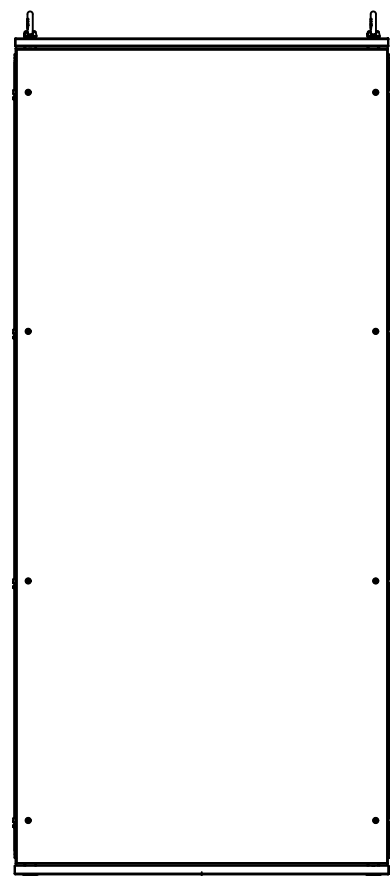

TOP



BACK

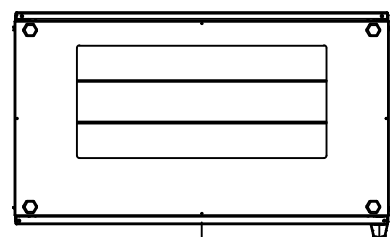

BOTTOM

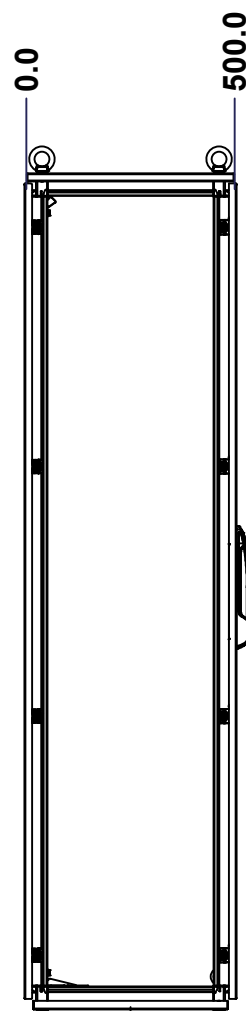

LEFT

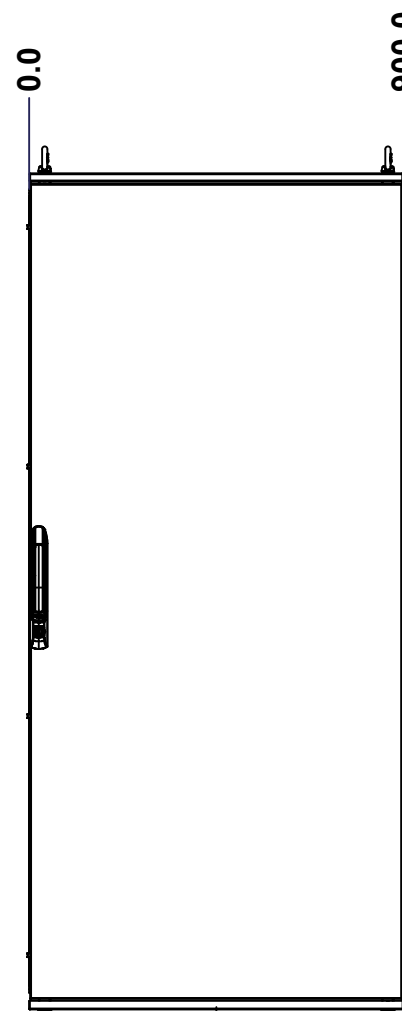

FRONT

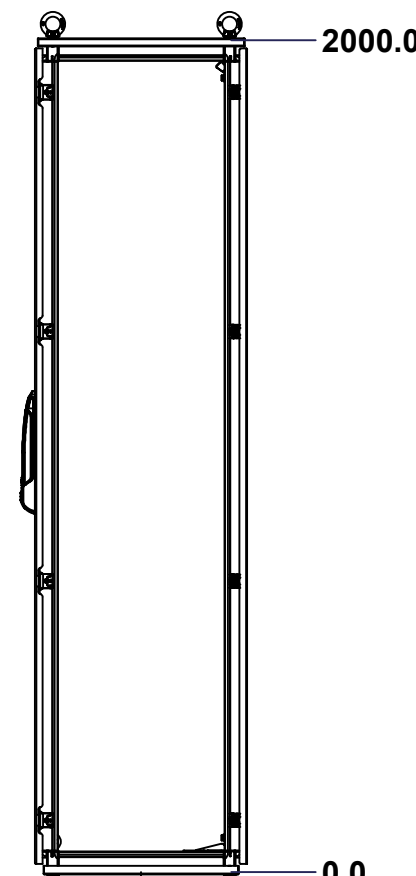

RIGHT

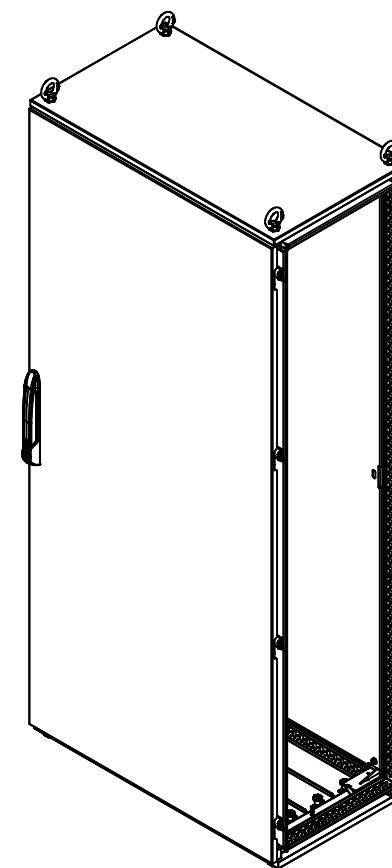

Isometric View

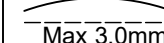
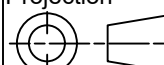

No.	Revisions	Date	By/Par

 Tél: (450) 979-4373 Fax: (450) 979-4626 www.exmweb.com		Flatness Aplatissement  Max 3.0mm Projection 
Customer Client		Date
Drawn By Dessiné Par	BoxCad: BoxCad	Date 08-Aug-14
Material Matière	See Part List	
Color Couleur	See Part List	Finish Fini See Part List
Description 6500MX 2000mm x 900mm x 500mm Assembly		Detail Rev.
Part Number Numéro Pièce	6500MXK200905	Rev. 1 0

SEE BILL OF MATERIAL ON LAST PAGE

This drawing is confidential and must not be reproduced or used without the consent of EXM

Ce dessin est confidentiel et ne doit pas être reproduit ou utilisé sans le consentement de EXM

No.	Revisions	Date	By/Par

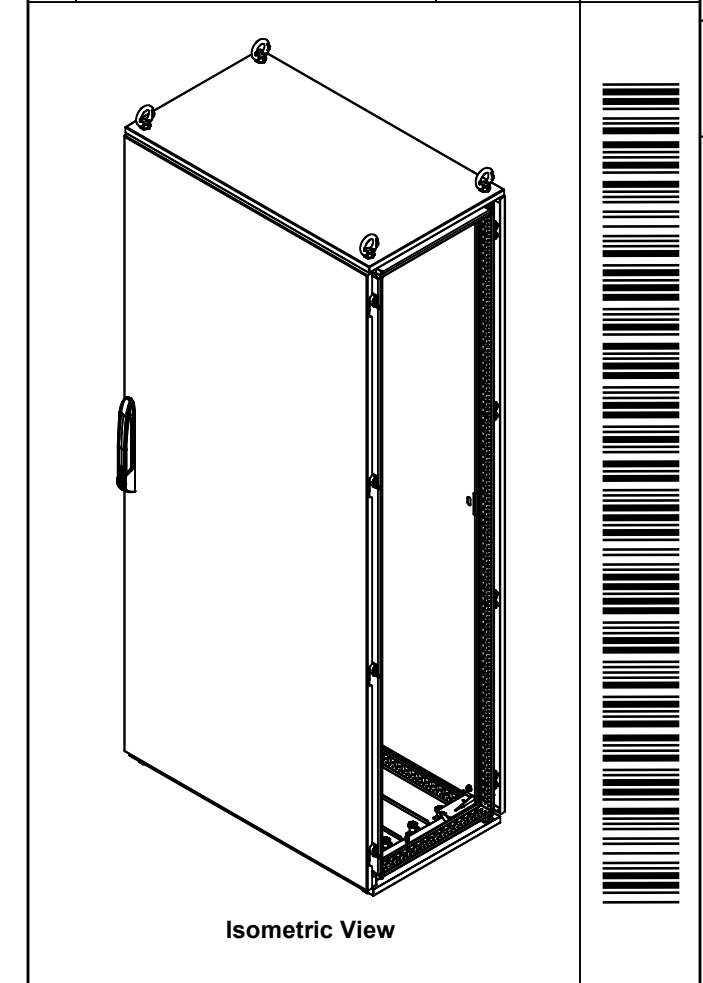

Tél: (450) 979-4373 Fax: (450) 979-4626 www.exmweb.com		Flatness Aplatissement
		Max 3.0mm
Customer Client		Date
Drawn By / Dessiné Par: BoxCad: BoxCad		Date: 08-Aug-14
Material / Matière: See Part List		
Color / Couleur: See Part List	Finish / Fini: See Part List	
Description: 6500MX 2000mm x 900mm x 500mm Assembly		Detail Rev.
Part Number / Numéro Pièce: 6500MXK200905		Rev. 2 0

Qty	Part Number	Rev	Description
1	6500MXK200905BIP	0	6500 MXM 2000mm x 900mm Back Inner Panel
1	6500MXK200905F	0	6500 MXD 2000mm x 900mm Front
1	6500MXK200905B	0	6500 MXR 2000mm x 900mm Back
1	6500MXK200905BT	0	6500 MXB 900mm x 500mm Bottom
1	6500MXK200905T	0	6500 MXT 900mm x 500mm Top
1	6500MXK200905FR	0	6500 MX 2000mm x 900mm x 500mm Frame
Parts List			

This drawing is confidential and must not be reproduced or used without the consent of EXM

Ce dessin est confidentiel et ne doit pas être reproduit ou utilisé sans le consentement de EXM

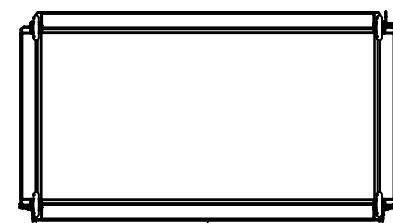

TOP

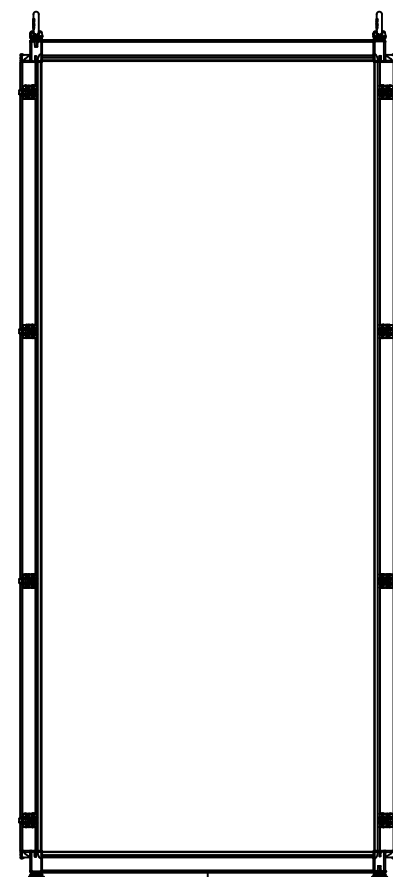

BACK

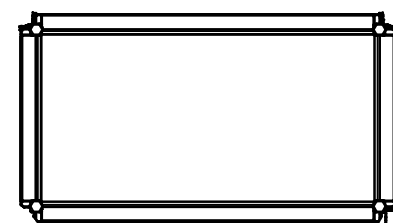

BOTTOM

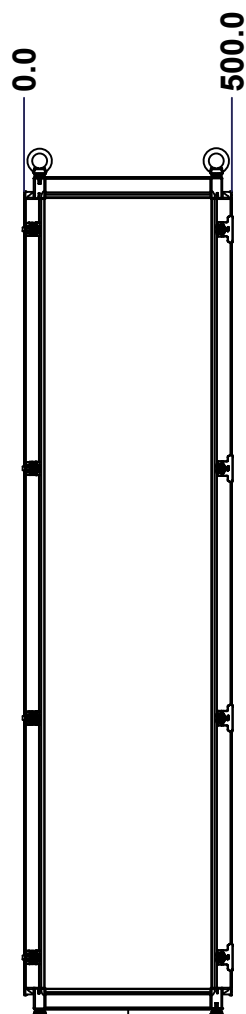

LEFT

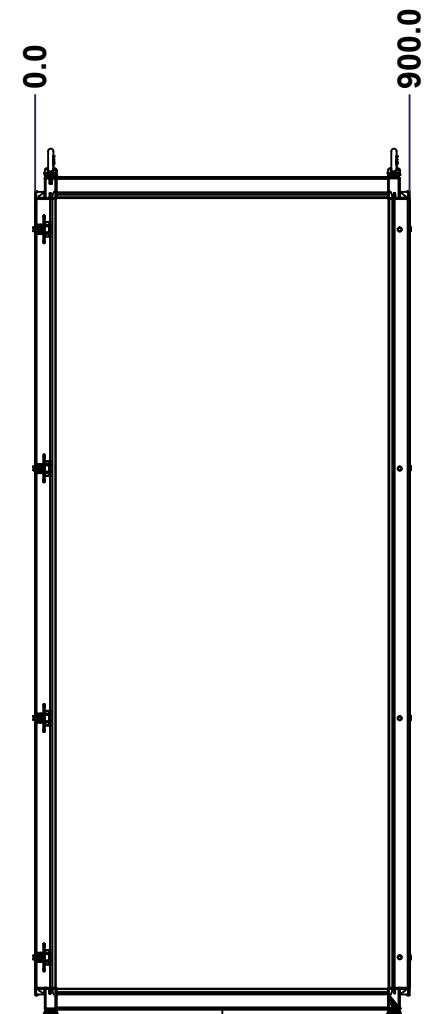

FRONT

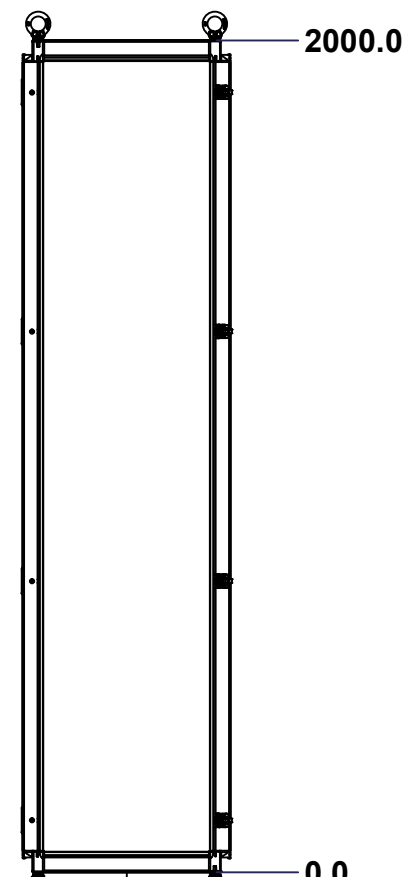

RIGHT

Grind excess weld off corner(s)

No.	Revisions	Date	By/Par

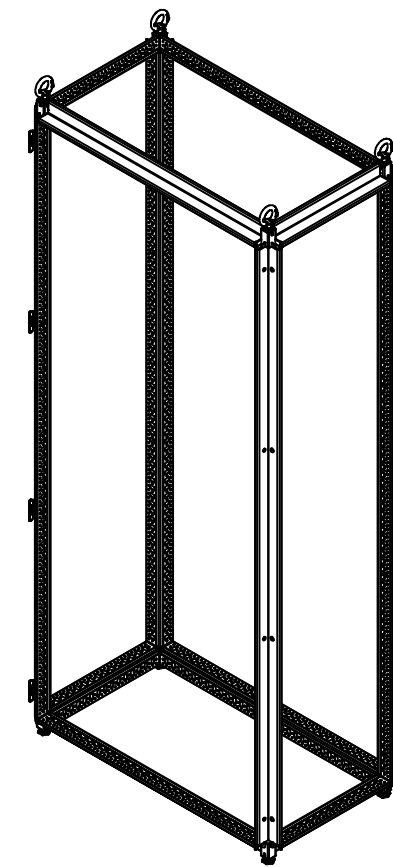

Isometric View

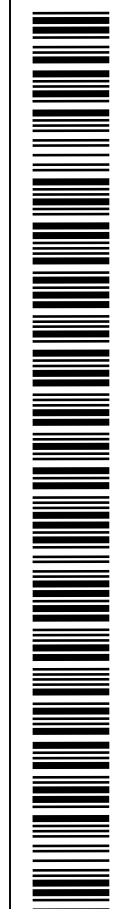

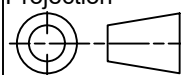
 Tél: (450) 979-4373 Fax: (450) 979-4626 www.exmweb.com		Flatness Aplatissement Max 3.0mm Projection 
Customer Client	Date	
Drawn By Dessiné Par	BoxCad: BoxCad	Date 08-Aug-14
Material Matière	16 Ga Electro-Galvanized (1.4mm)	
Color Couleur	Iron Grey RAL7011	Finish Fini Textured
Description 6500 MX 2000mm x 900mm x 500mm Frame		Detail Rev.
Part Number Numéro Pièce	6500MXK200905FR	Rev. 3 0

SEE BILL OF MATERIAL ON LAST PAGE

This drawing is confidential and must not be reproduced or used without the consent of EXM

Ce dessin est confidentiel et ne doit pas être reproduit ou utilisé sans le consentement de EXM

No.	Revisions	Date	By/Par

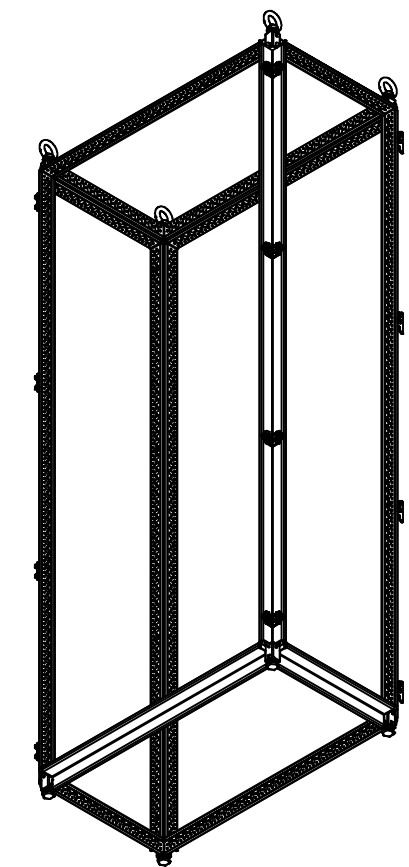

Isometric View



Qty	Part Number	Rev	Description
1	STK-P-03810ST	0	Powder Paint (Iron Grey /Sand Textured)
4	STK-Q-47250-09	6	6500 MX 900mm Horizontal Frame Post Part
4	STK-Q-47250-05	6	6500 MX 500mm Horizontal Frame Post Part
4	STK-A-70589	9	6500 MX Fixed Side Panel Bracket Assembly
16	STK-Q-77120	1	6500MX-Frame Rubber Plug
8	STK-A-70580	9	Mtrx Bracket
8	STK-Q-00610	3	M16 x 30.0mm Bolt
8	STK-A-49448	6	6500 MX - Frame Sheet Metal Corner Assembly
4	STK-Q-49500	3	M12 Eye Bolt (0.34T)
4	STK-Q-61110	0	M12 Feet Leveler
4	STK-Q-47251-20	6	6500 MX 2000mm Vertical Frame Post Part
Parts List			

Tél: (450) 979-4373 Fax: (450) 979-4626 www.exmweb.com		Flatness Aplatissement Max 3.0mm Projection
Customer Client	Date	
Drawn By Dessiné Par	BoxCad: BoxCad	Date 08-Aug-14
Material Matière	16 Ga Electro-Galvanized (1.4mm)	
Color Couleur	Iron Grey RAL7011	Finish Fini Textured
Description	Detail Rev.	
6500 MX 2000mm x 900mm x 500mm Frame		
Part Number Numéro Pièce	Rev.	4
6500MXK200905FR	0	18

This drawing is confidential and must not be reproduced or used without the consent of EXM

Ce dessin est confidentiel et ne doit pas être reproduit ou utilisé sans le consentement de EXM

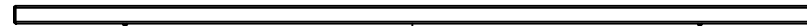

TOP

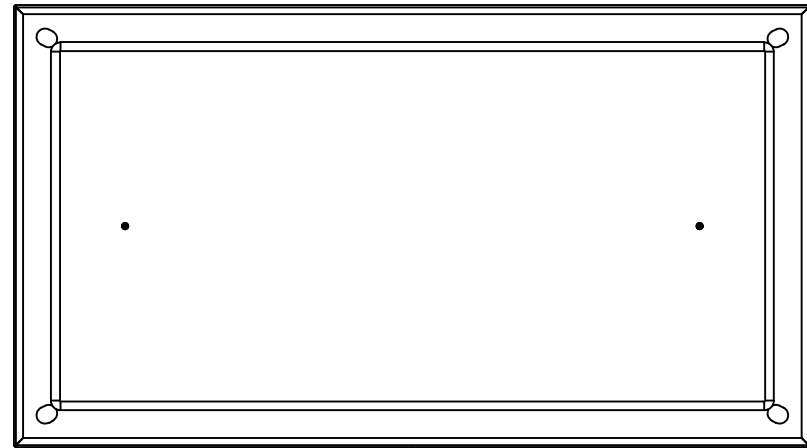

BACK

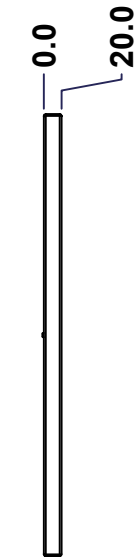

LEFT

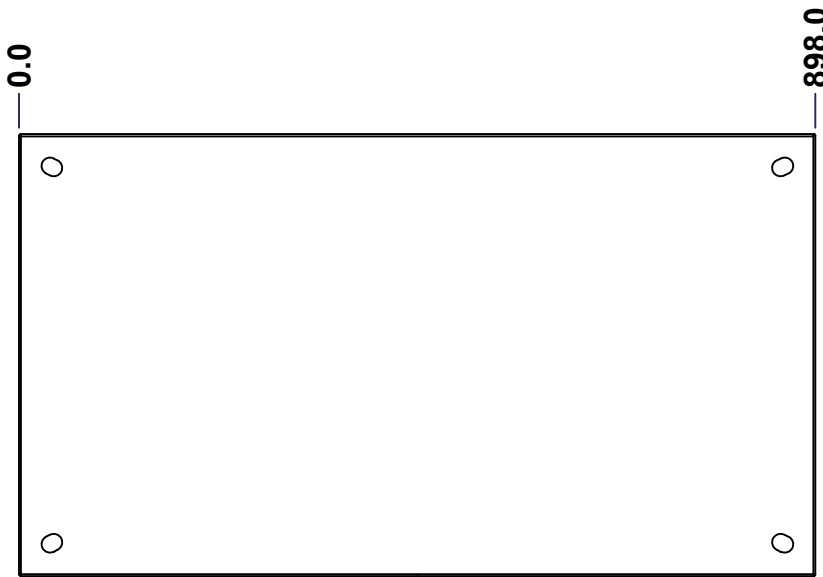

FRONT

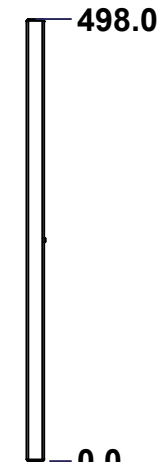



RIGHT

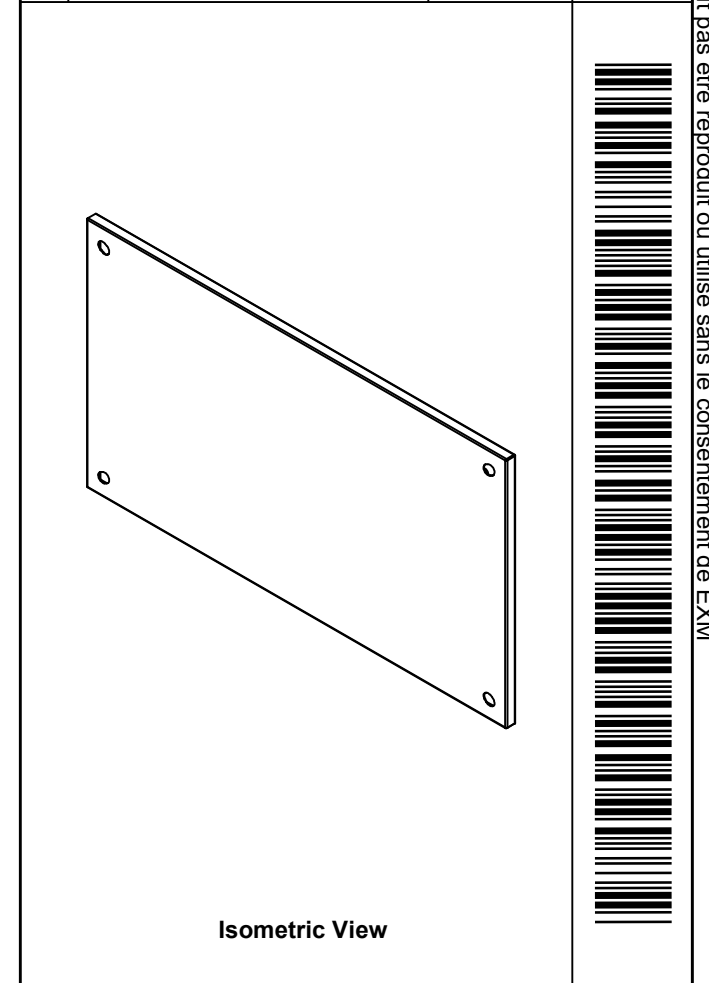

BOTTOM

No.	Revisions	Date	By/Par

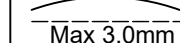
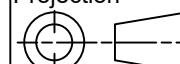

 Tél: (450) 979-4373 Fax: (450) 979-4626 www.exmweb.com		Flatness Aplatissement  Max 3.0mm
Customer Client Drawn By / Dessiné Par: BoxCad: BoxCad Material / Matière: 16 Ga Cold Rolled A1008 CS Type B		Projection  Date: 08-Aug-14
Color / Couleur: Iron Grey RAL7011 Finish / Fini: Textured		Detail Rev.
Description: 6500 MXT 900mm x 500mm Top		Part Number / Numéro Pièce: 6500MXK200905T
Use gasket program path 6500 MX > 6500 MXT		Rev. 5 0

SEE BILL OF MATERIAL ON LAST PAGE

This drawing is confidential and must not be reproduced or used without the consent of EXM

Ce dessin est confidentiel et ne doit pas être reproduit ou utilisé sans le consentement de EXM

STANDARD FEATURES ARE NOT LISTED IN THIS HOLE TABLE			
HOLE TABLE - FRONT VIEW (CUSTOM FEATURE ONLY)			
CUT-OUT	XDIM	YDIM	DESCRIPTION
1	125.0	249.0	GND STUD M6 x 18mm (Inside)
2	773.0	249.0	GND STUD M6 x 18mm (Inside)

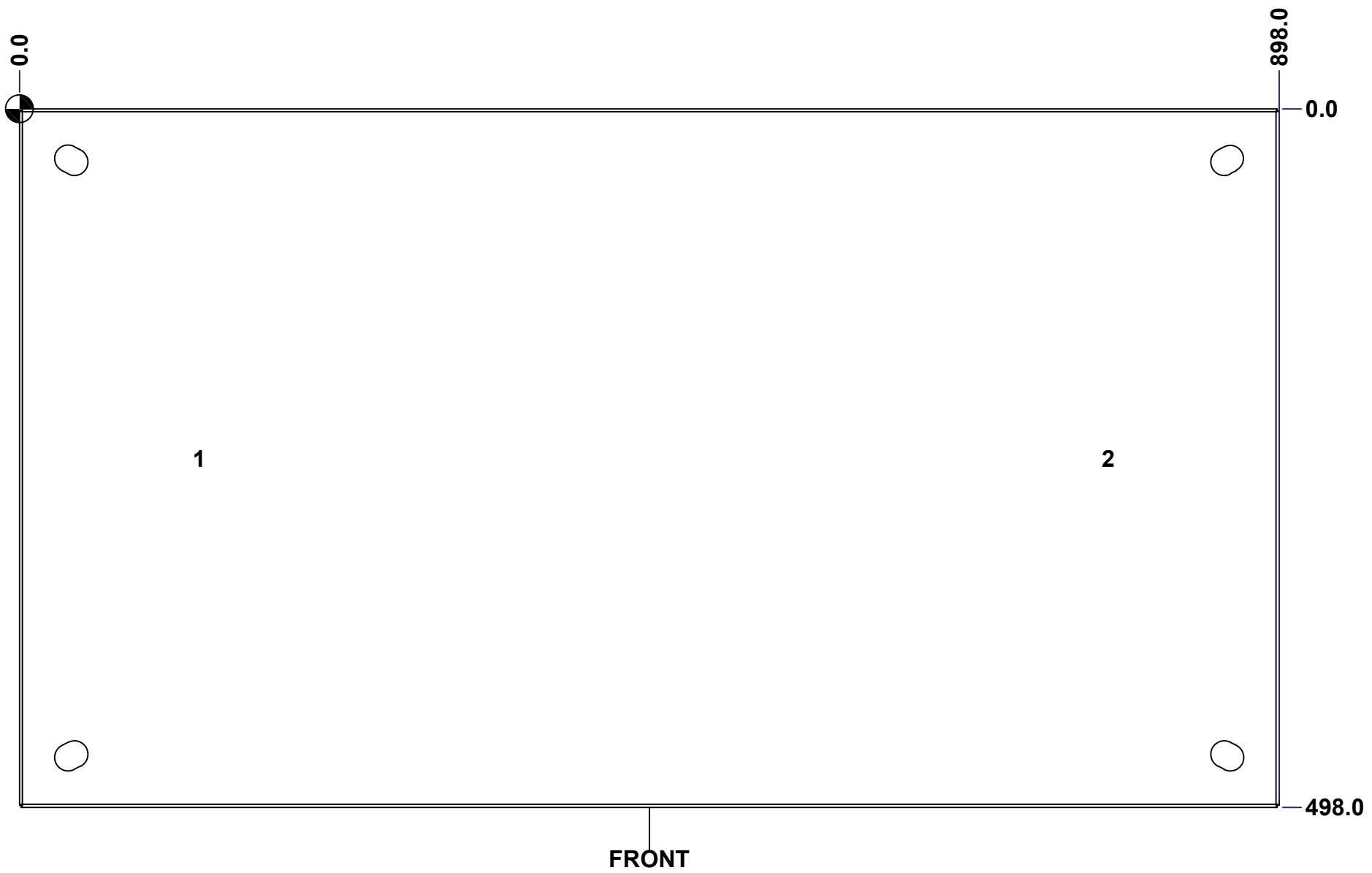

Use bending program path 6500 MX > 6500 MXT

	Description		Status
	6500 MXT 900mm x 500mm Top		(NULL)
Part Number Numéro Pièce		Rev.	6
6500MXK200905T		0	18

This drawing is confidential and must not be reproduced or used without the consent of EXM

Ce dessin est confidentiel et ne doit pas être reproduit ou utilisé sans le consentement de EXM

No.	Revisions	Date	By/Par

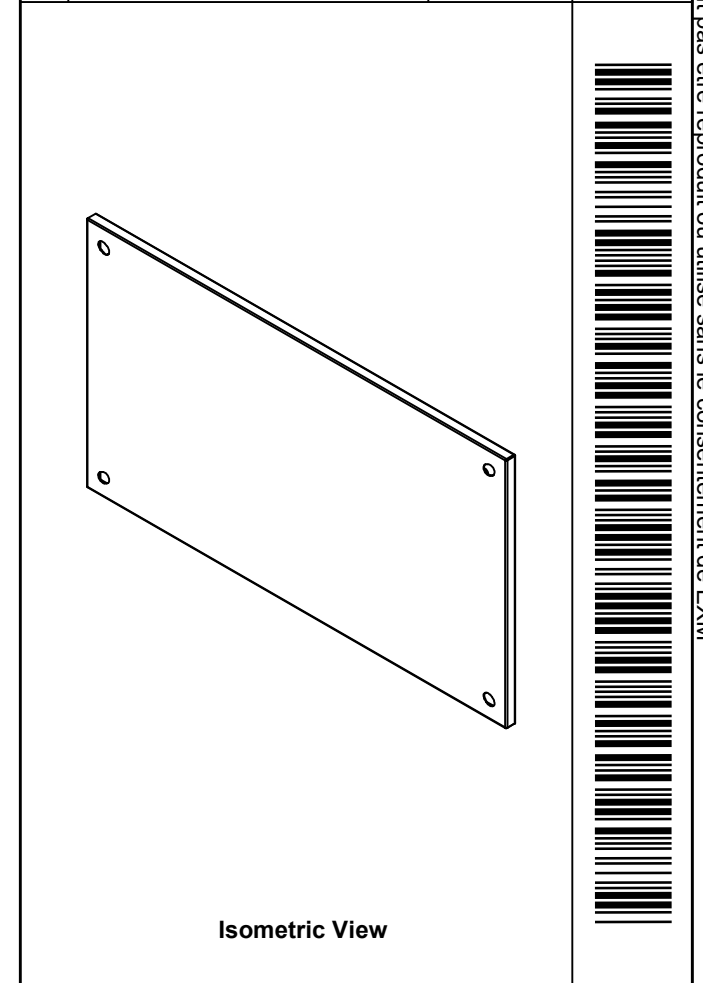

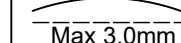
 Tél: (450) 979-4373 Fax: (450) 979-4626 www.exmweb.com		Flatness Aplatissement  Max 3.0mm
Customer Client		Date
Drawn By / Dessiné Par: BoxCad: BoxCad		Date: 08-Aug-14
Material / Matière: 16 Ga Cold Rolled A1008 CS Type B		
Color / Couleur: Iron Grey RAL7011	Finish / Fini: Textured	
Description: 6500 MXT 900mm x 500mm Top		Detail Rev.
Part Number / Numéro Pièce: 6500MXK200905T		Rev. 7 / 18

Qty	Part Number	Rev	Description
1	STK-P-03810ST	0	Powder Paint (Iron Grey /Sand Textured)
2	STK-Q-16055	1	M6 x 18mm Stud (No Paint Cap Required)
1	6500MXK200905TG	0	6500 MXT 900mm x 500mm Top Gasket
1	6500MXK200905T-P	0	6500 MXT 900mm x 500mm Top Part
Parts List			

This drawing is confidential and must not be reproduced or used without the consent of EXM

Ce dessin est confidentiel et ne doit pas être reproduit ou utilisé sans le consentement de EXM

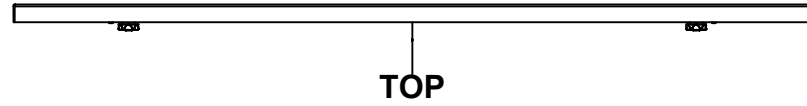

TOP

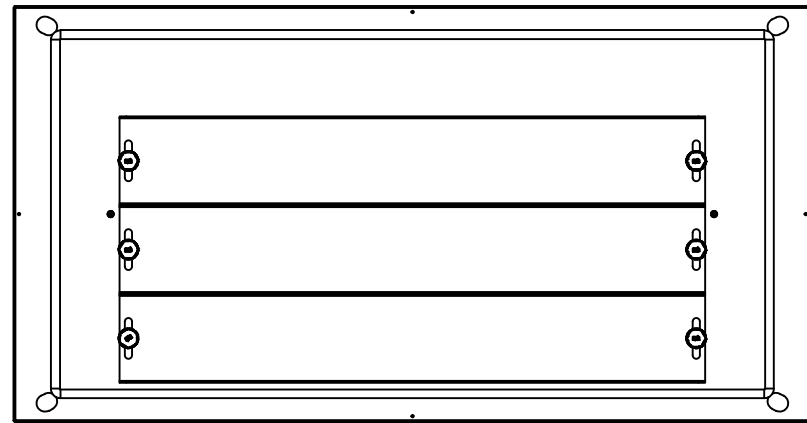

BACK

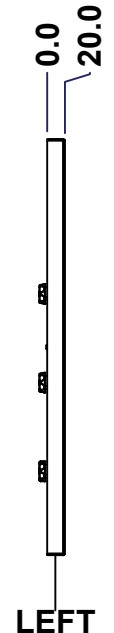

LEFT

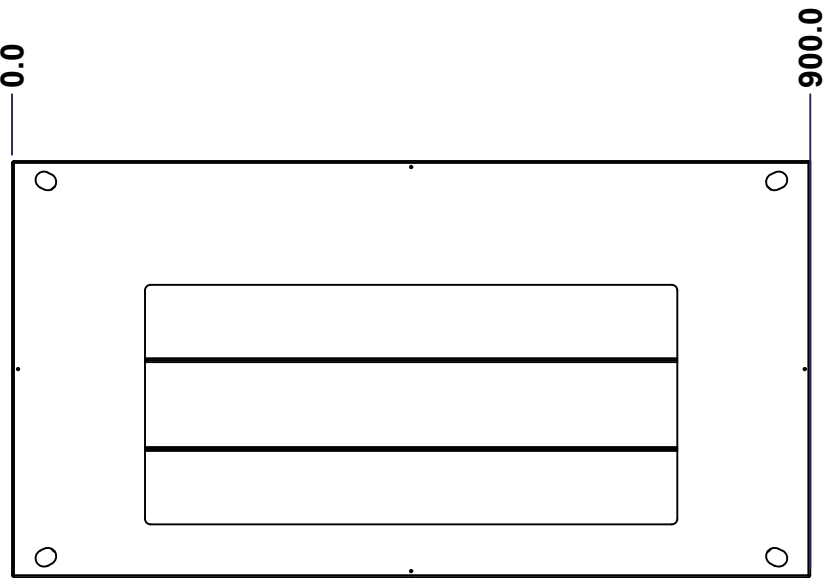

FRONT

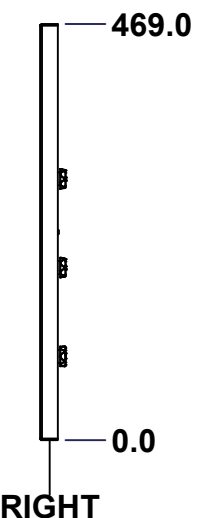

RIGHT

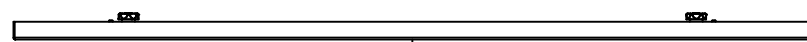

BOTTOM

No.	Revisions	Date	By/Par

Isometric View

<p>Tél: (450) 979-4373 Fax: (450) 979-4626 www.exmweb.com</p>		Flatness Aplatissement	
		Max 3.0mm	
Customer Client		Date	
Drawn By Dessiné Par		Date	
Material Matière		Projection	
Color Couleur		Finish Fini	
Description		Detail Rev.	
Part Number Numéro Pièce		Rev.	8
<p>Use gasket program path 6500 MX > 6500MXB</p> <p style="text-align: center;">SEE BILL OF MATERIAL ON LAST PAGE</p>		<p>16 Ga Cold Rolled A1008 CS Type B</p> <p>Iron Grey RAL7011</p> <p>6500 MXB 900mm x 500mm Bottom</p> <p>6500MXK200905BT</p>	<p>0</p> <p>18</p>

This drawing is confidential and must not be reproduced or used without the consent of EXM

Ce dessin est confidentiel et ne doit pas être reproduit ou utilisé sans le consentement de EXM

STANDARD FEATURES ARE NOT LISTED IN THIS HOLE TABLE

HOLE TABLE - FRONT VIEW (CUSTOM FEATURE ONLY)

CUT-OUT	XDIM	YDIM	DESCRIPTION
1	110.0	234.5	GND STUD M6 x 18mm (Inside)
2	790.0	234.5	GND STUD M6 x 18mm (Inside)
3	130.0	294.5	GP STUD M6 x 18mm (Inside)
4	770.0	294.5	GP STUD M6 x 18mm (Inside)
5	130.0	194.5	GP STUD M6 x 18mm (Inside)
6	770.0	194.5	GP STUD M6 x 18mm (Inside)
7	130.0	94.5	GP STUD M6 x 18mm (Inside)
8	770.0	94.5	GP STUD M6 x 18mm (Inside)

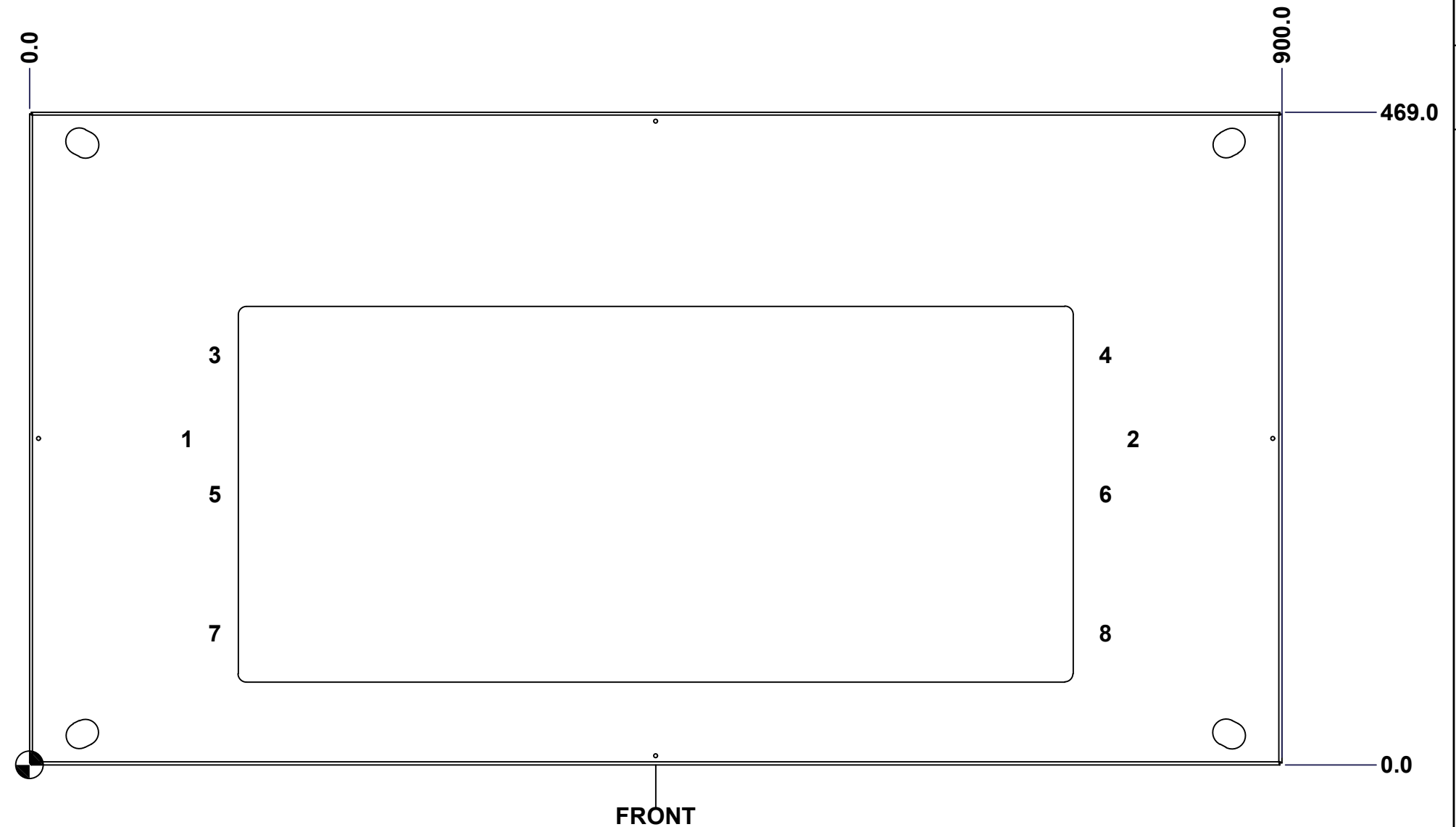

Use bending program path 6500 MX > 6500MXB

	Description	Status
	6500 MXB 900mm x 500mm Bottom	(NULL)
	Part Number Numéro Pièce	Rev.
	6500MXK200905BT	0 / 9
		18

This drawing is confidential and must not be reproduced or used without the consent of EXM

Ce dessin est confidentiel et ne doit pas être reproduit ou utilisé sans le consentement de EXM

No.	Revisions	Date	By/Par

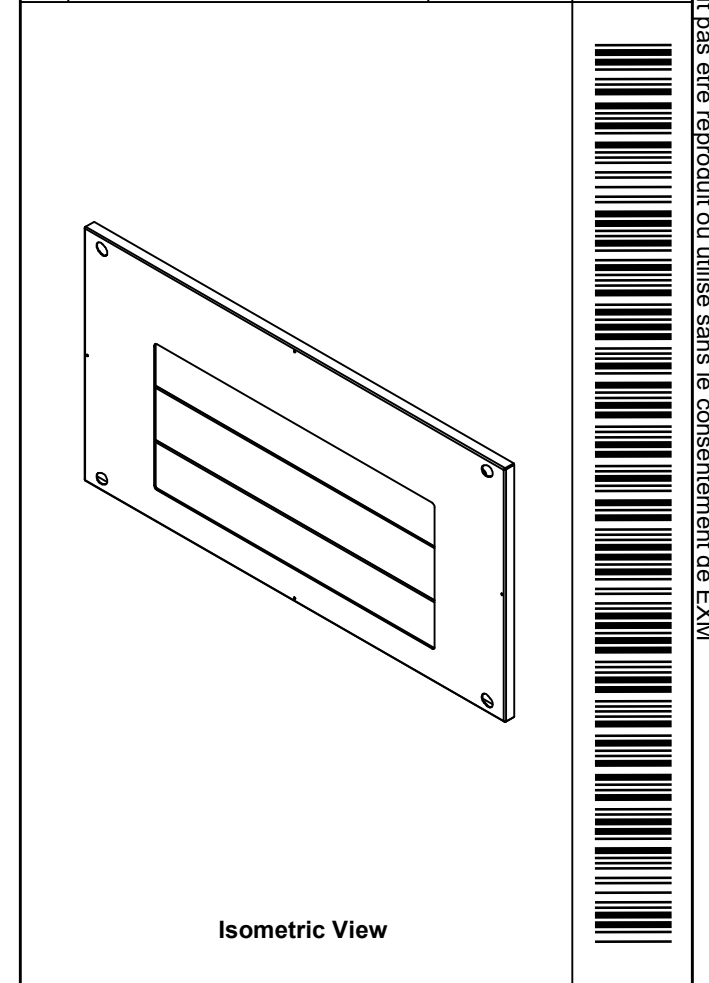

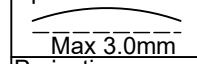
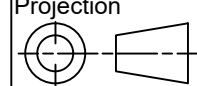
 Tél: (450) 979-4373 Fax: (450) 979-4626 www.exmweb.com		Flatness Aplatissement  Max 3.0mm
Projection 		
Customer Client		Date
Drawn By / Dessiné Par: BoxCad: BoxCad		Date: 08-Aug-14
Material / Matière: 16 Ga Cold Rolled A1008 CS Type B		
Color / Couleur: Iron Grey RAL7011	Finish / Fini: Textured	
Description: 6500 MXB 900mm x 500mm Bottom		Detail Rev.
Part Number / Numéro Pièce: 6500MXK200905BT		Rev. 0
		10 18

Qty	Part Number	Rev	Description
1	STK-P-03810ST	0	Powder Paint (Iron Grey /Sand Textured)
6	STK-Q-06001	0	Mtrx - Gland Plate M6 Plastic Thumb Nut
8	STK-Q-16055	1	M6 x 18mm Stud (No Paint Cap Required)
3	6500MXK200905GP100-P	0	6500 MXB 900mm Gland Plate Part (100mm)
1	6500MXK200905BTGPG	0	6500 MXB 900mm x 500mm Bottom Gland Plate Gasket
1	6500MXK200905BTG	0	6500 MXB 900mm x 500mm Bottom Gasket
1	6500MXK200905BT-P	0	6500 MXB 900mm x 500mm Bottom Part
Parts List			

This drawing is confidential and must not be reproduced or used without the consent of EXM

Ce dessin est confidentiel et ne doit pas être reproduit ou utilisé sans le consentement de EXM

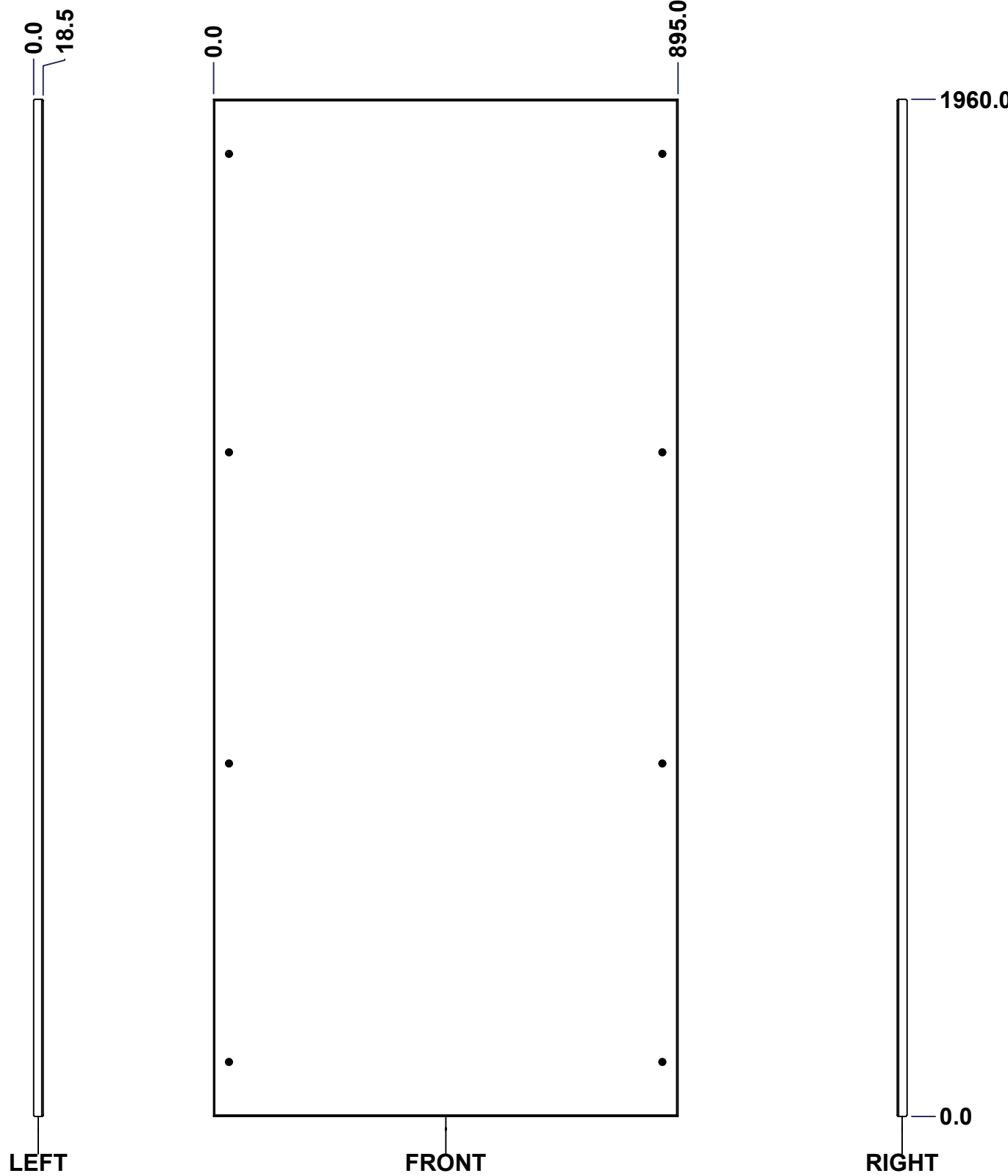
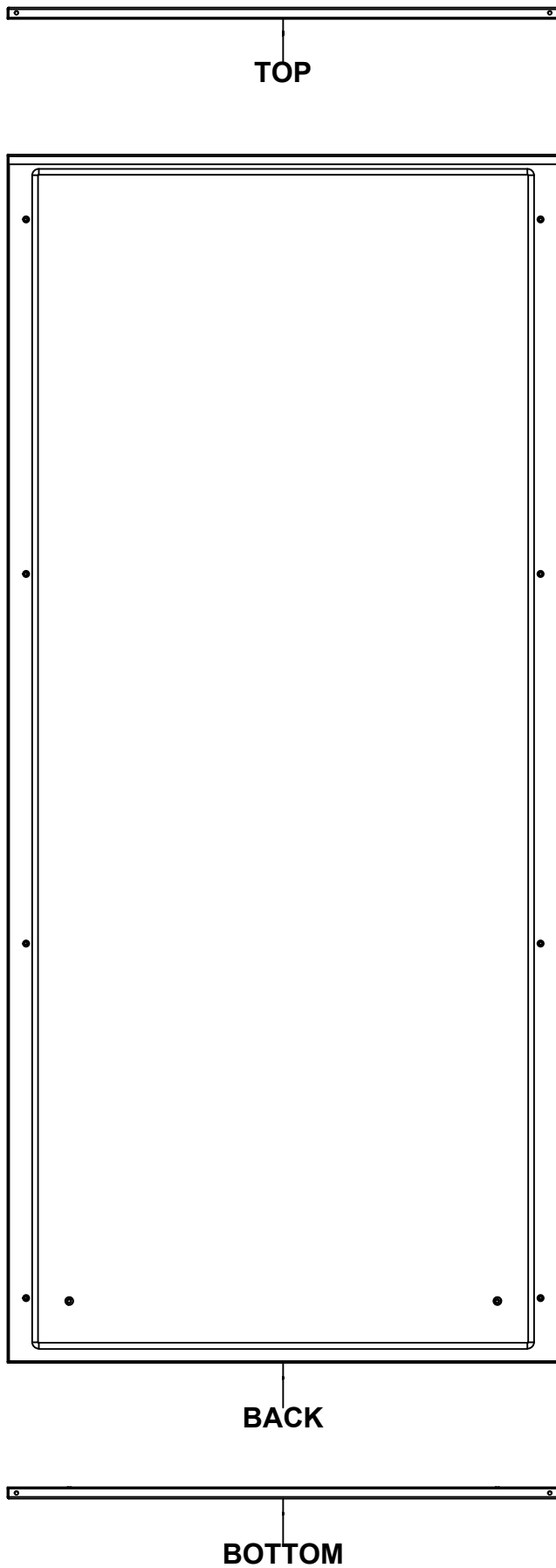

No.	Revisions	Date	By/Par

Isometric View

<p>Tél: (450) 979-4373 Fax: (450) 979-4626 www.exmweb.com</p>		Flatness Aplatissement
		Max 3.0mm
Projection		
Customer Client	Date	
Drawn By Dessiné Par	BoxCad: BoxCad	Date 08-Aug-14
Material Matière	14 Ga Cold Rolled A1008 CS Type B	
Color Couleur	Light Grey RAL7035	Finish Fini Textured
Description		Detail Rev.
6500 MXR 2000mm x 900mm Back		
Part Number Numéro Pièce	Rev.	11
6500MXK200905B	0	18

Use gasket program path 6500 MX > 6500 MXR

SEE BILL OF MATERIAL ON LAST PAGE

This drawing is confidential and must not be reproduced or used without the consent of EXM

Ce dessin est confidentiel et ne doit pas être reproduit ou utilisé sans le consentement de EXM

STANDARD FEATURES ARE NOT LISTED IN THIS HOLE TABLE			
HOLE TABLE - FRONT VIEW (CUSTOM FEATURE ONLY)			
CUT-OUT	XDIM	YDIM	DESCRIPTION
1	100.0	100.0	GND STUD M6 x 16mm (Inside)
2	795.0	100.0	GND STUD M6 x 16mm (Inside)

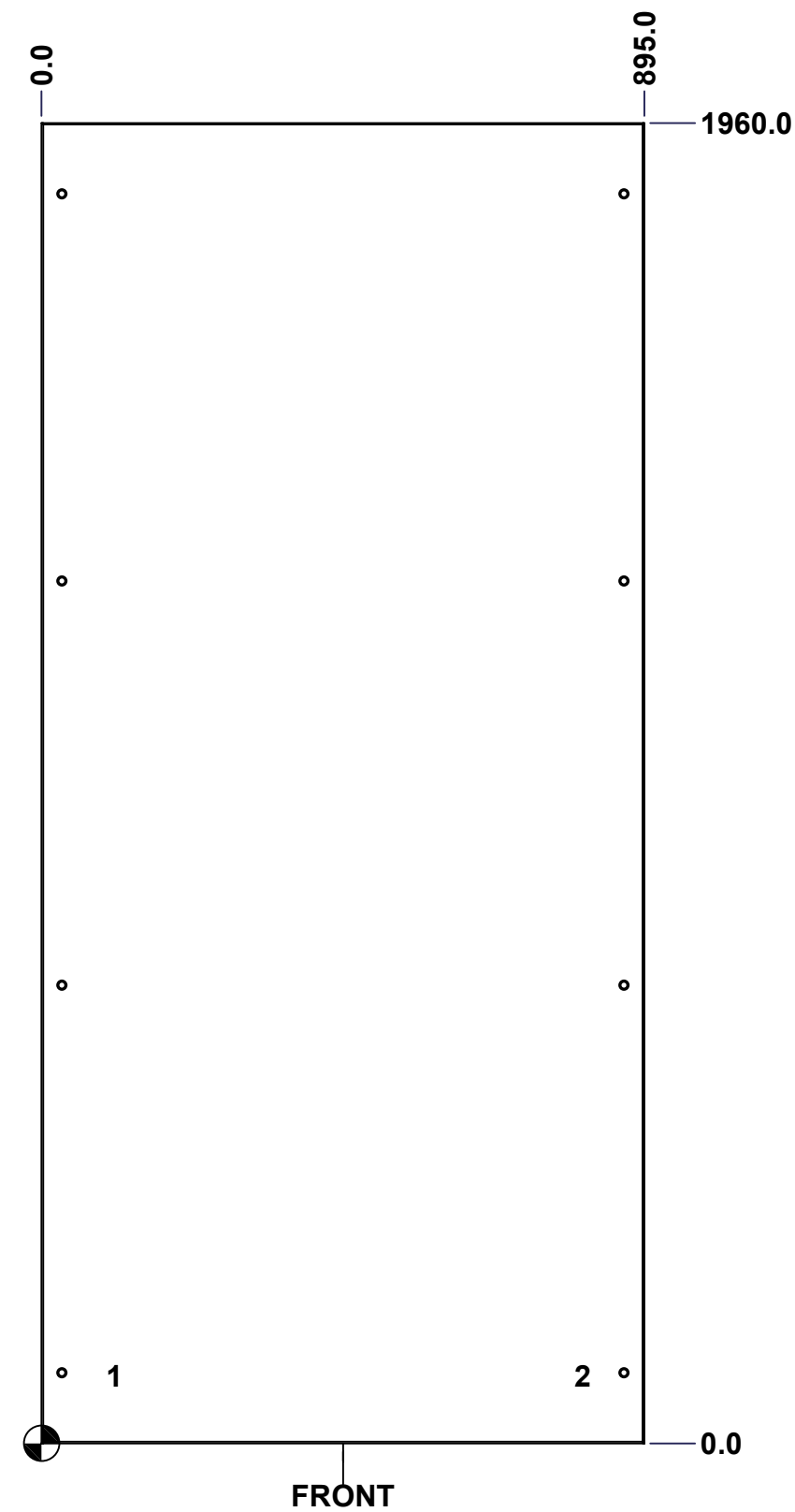

Use bending program path 6500 MX > 6500 MXR

	Description	Status
	6500 MXR 2000mm x 900mm Back	(NULL)
	Part Number Numéro Pièce	Rev.
	6500MXK200905B	0
		12
		18

This drawing is confidential and must not be reproduced or used without the consent of EXM

Ce dessin est confidentiel et ne doit pas être reproduit ou utilisé sans le consentement de EXM

No.	Revisions	Date	By/Par

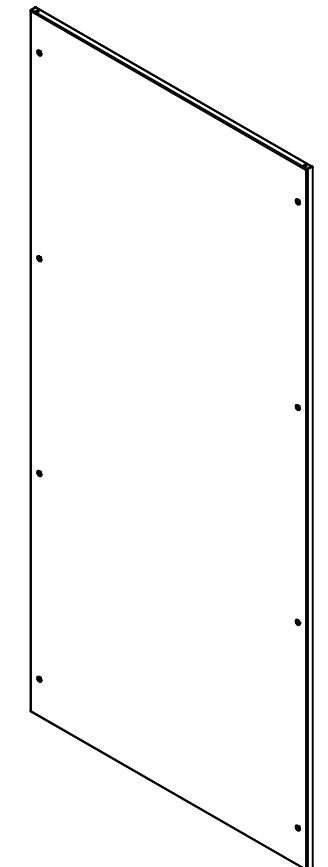

Isometric View

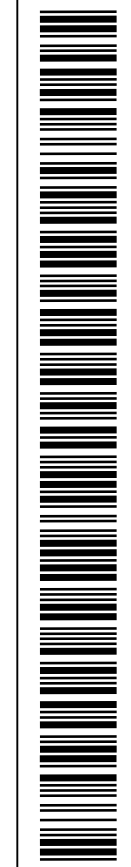

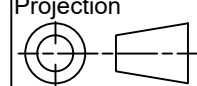
		Tél: (450) 979-4373 Fax: (450) 979-4626 www.exmweb.com		Flatness Aplatissement Max 3.0mm	
Customer Client		Date		Projection 	
Drawn By Dessiné Par		BoxCad: BoxCad		Date 08-Aug-14	
Material Matière		14 Ga Cold Rolled A1008 CS Type B			
Color Couleur		Light Grey RAL7035		Finish Fini Textured	
Description 6500 MXR 2000mm x 900mm Back				Detail Rev.	
Part Number Numéro Pièce		6500MXK200905B		Rev. 13 0	

Qty	Part Number	Rev	Description
1	STK-P-03820R	0	Powder Paint (Light Grey / Rough Textured)
1	6500MXK200905BG	0	6500 MXR 2000mm x 900mm Back Gasket
8	STK-Q-03071	0	M6 x 16mm Machine Screw
2	STK-Q-16080	0	Ground Stud M6 x 16mm Steel
1	6500MXK200905B-P	0	6500 MXR 2000mm x 900mm Back Part
Parts List			

This drawing is confidential and must not be reproduced or used without the consent of EXM

Ce dessin est confidentiel et ne doit pas être reproduit ou utilisé sans le consentement de EXM

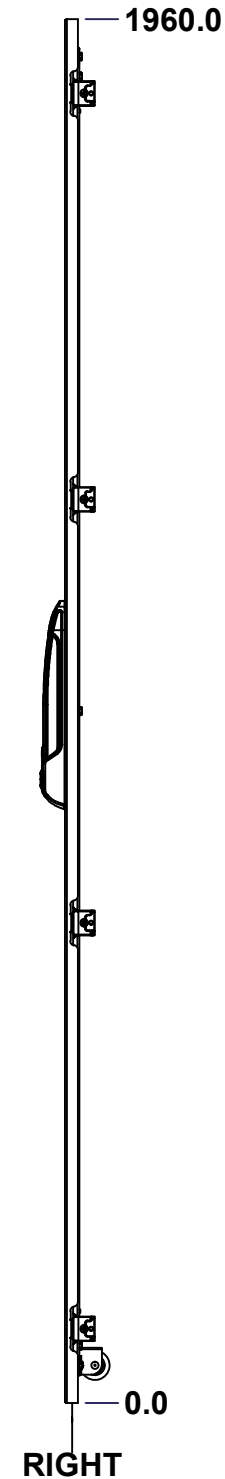
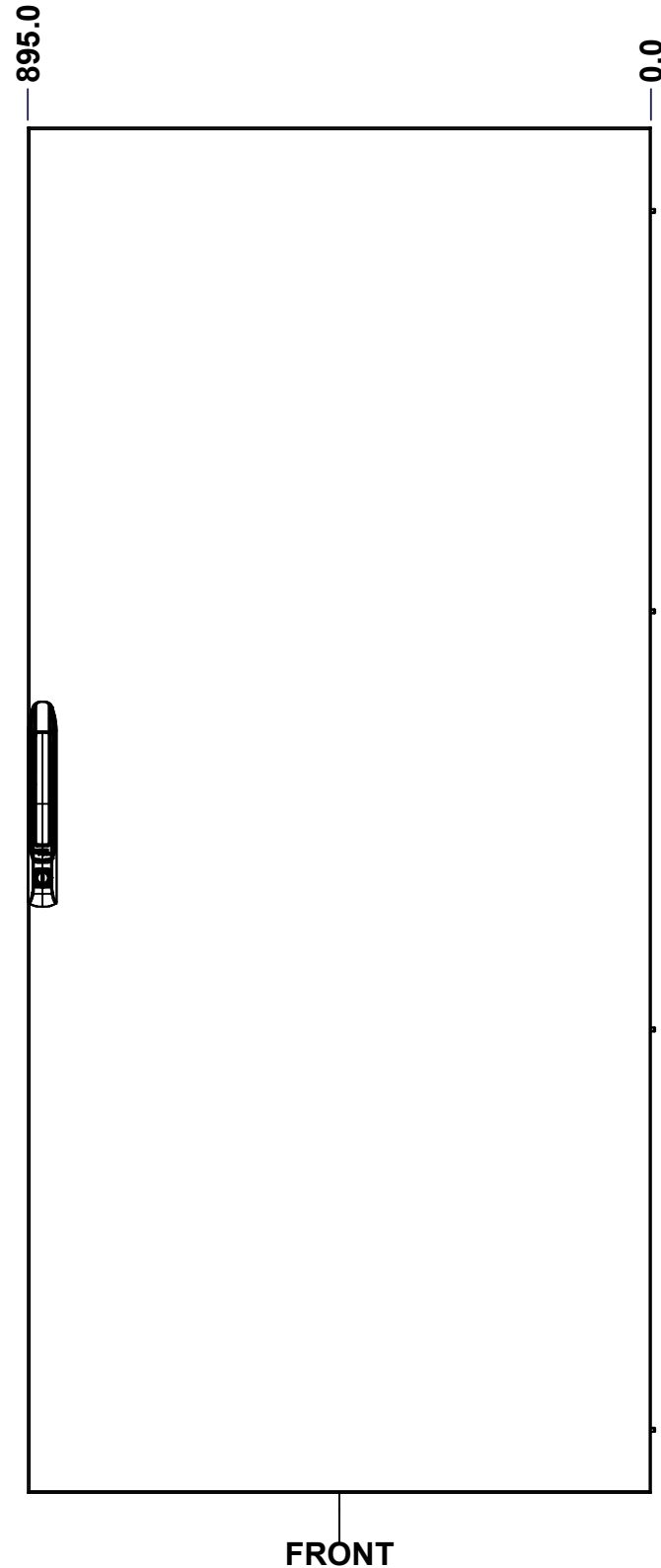
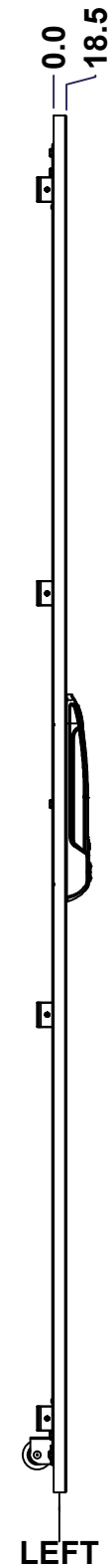
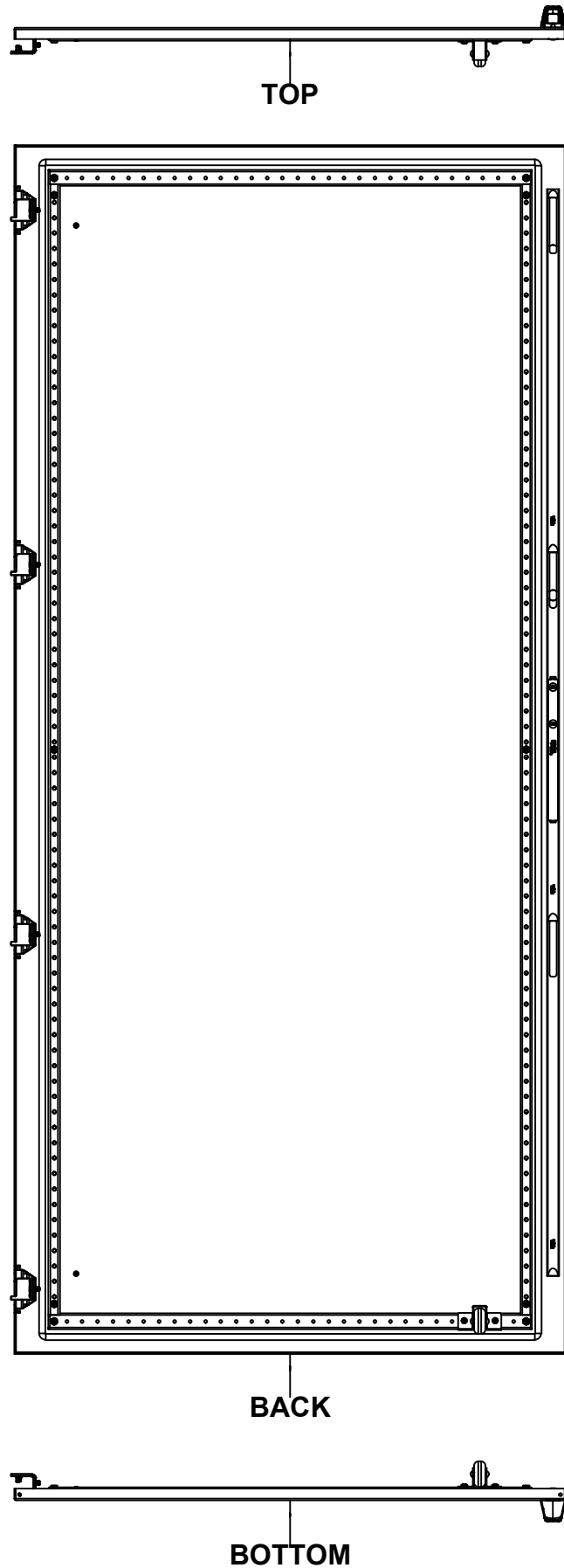

No.	Revisions	Date	By/Par

Isometric View

Tél: (450) 979-4373 Fax: (450) 979-4626 www.exmweb.com		Flatness Aplatissement
		Max 3.0mm
Customer Client Drawn By / Dessiné Par: BoxCad: BoxCad Material / Matière: 14 Ga Cold Rolled A1008 CS Type B		Projection
Date		Date
Date 08-Aug-14		Date
Color / Couleur: Light Grey RAL7035		Finish / Fini: Textured
Description: 6500 MXD 2000mm x 900mm Front		Detail Rev.
Part Number / Numéro Pièce: 6500MXK200905F		Rev. 14
		0

Use gasket program path 6500 MX > 6500 MXD

SEE BILL OF MATERIAL ON LAST PAGE

This drawing is confidential and must not be reproduced or used without the consent of EXM

Ce dessin est confidentiel et ne doit pas être reproduit ou utilisé sans le consentement de EXM

STANDARD FEATURES ARE NOT LISTED IN THIS HOLE TABLE

HOLE TABLE - FRONT VIEW (CUSTOM FEATURE ONLY)

CUT-OUT	XDIM	YDIM	DESCRIPTION
1	100.0	130.0	GND STUD M6 x 16mm (Inside)
2	100.0	1830.0	GND STUD M6 x 16mm (Inside)
3	64.5	52.8	STIFF. STUD M6 x 18mm (Inside)
4	64.5	1907.2	STIFF. STUD M6 x 18mm (Inside)
5	830.5	52.8	STIFF. STUD M6 x 18mm (Inside)
6	830.5	1907.2	STIFF. STUD M6 x 18mm (Inside)
7	64.5	980.0	STIFF. STUD M6 x 18mm (Inside)
8	830.5	980.0	STIFF. STUD M6 x 18mm (Inside)
9	830.5	1879.0	STIFF. STUD M6 x 18mm (Inside)
10	830.5	81.0	STIFF. STUD M6 x 18mm (Inside)
11	64.5	1879.0	STIFF. STUD M6 x 18mm (Inside)
12	64.5	81.0	STIFF. STUD M6 x 18mm (Inside)
13	874.0	170.0	LARGE CBAR GUIDE (Inside)
14	874.0	1790.0	LARGE CBAR GUIDE (Inside)
15	874.0	730.0	LARGE CBAR GUIDE (Inside)
16	874.0	1230.0	LARGE CBAR GUIDE (Inside)

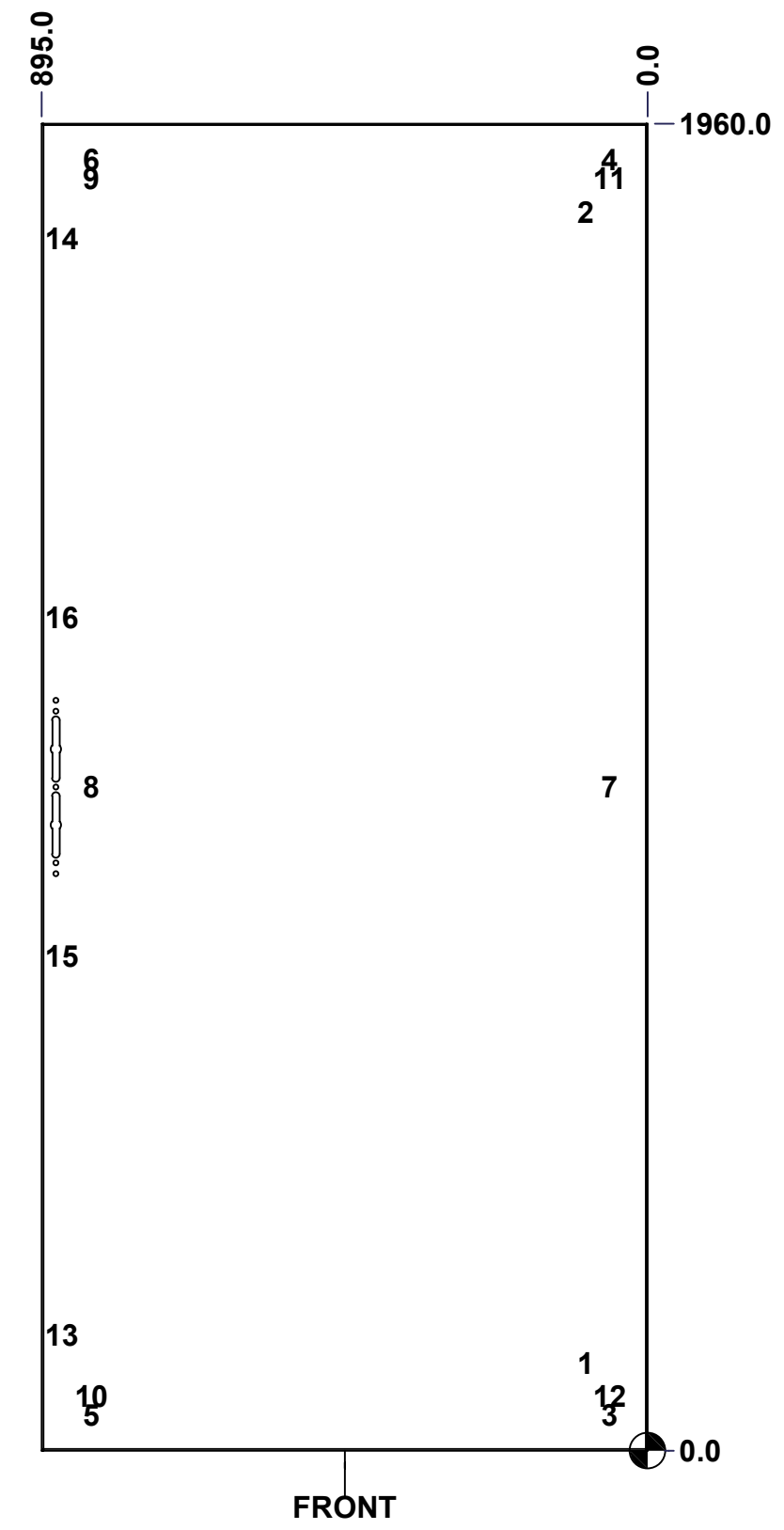

Use bending program path 6500 MX > 6500 MXD

	Description 6500 MXD 2000mm x 900mm Front	Status (NULL)
	Part Number Numéro Pièce 6500MXK200905F	Rev. 15 0

This drawing is confidential and must not be reproduced or used without the consent of EXM

Ce dessin est confidentiel et ne doit pas être reproduit ou utilisé sans le consentement de EXM

No.	Revisions	Date	By/Par

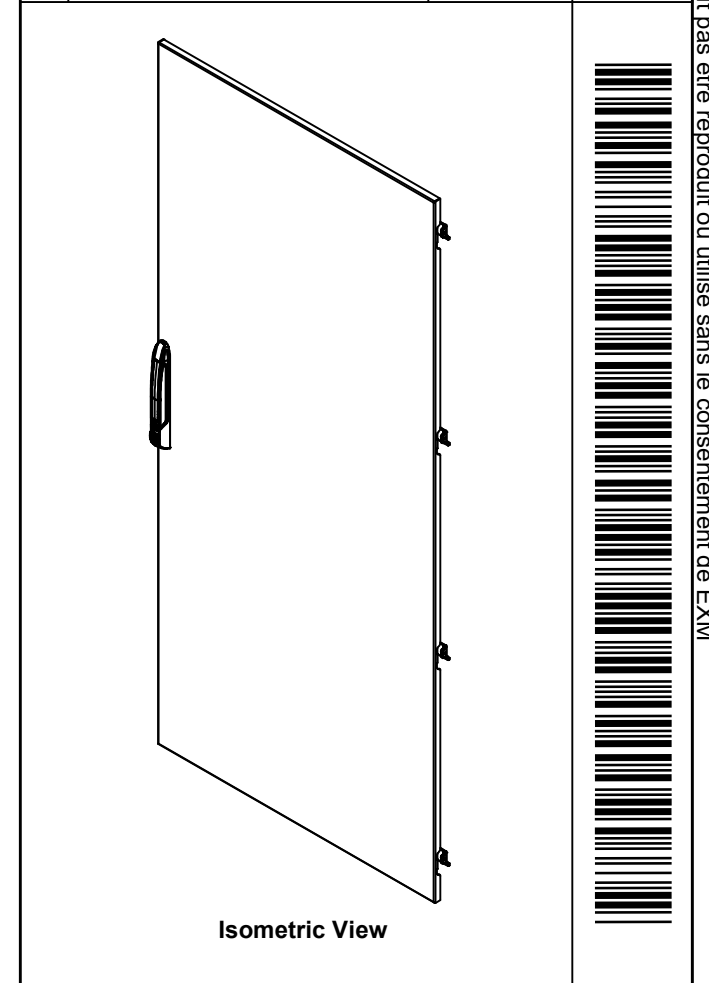

Qty	Part Number	Rev	Description
1	STK-P-03820R	0	Powder Paint (Light Grey / Rough Textured)
1	STK-A-45758	4	886 PH2 Pull Handle Bridge - Assembly
1	STK-A-51160	0	886PH2-SL - Pull Handle Lock - Assembly
1	STK-Q-45662-20	1	6500 MX - Lower Closing Bar 2000mm
1	STK-Q-45661-20	1	6500 MX - Upper Closing Bar 2000mm
1	6500MXSRK	1	6500 MXRSK Door Support Roller
4	STK-Q-16410	0	Guide Stud - Large (No Paint Cap Required)
4	STK-K-06810	7	6500 MX Hinge Assy
12	STK-Q-16055	1	M6 x 18mm Stud (No Paint Cap Required)
1	6500MXK200905DS1	5	6500 MX 2000mm x 900mm Door Stiffener
1	6500MXK200905FG	0	6500 MXD 2000mm x 900mm Front Gasket
1	6500MXK200905F-P	0	6500 MXD 2000mm x 900mm Front Part

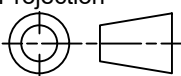
 Tél: (450) 979-4373 Fax: (450) 979-4626 www.exmweb.com		Flatness Aplatissement Max 3.0mm Projection 
Customer Client	Date	
Drawn By Dessiné Par	BoxCad: BoxCad	Date 08-Aug-14
Material Matière	14 Ga Cold Rolled A1008 CS Type B	
Color Couleur	Light Grey RAL7035	Finish Fini Textured
Description	Detail Rev.	
6500 MXD 2000mm x 900mm Front		
Part Number Numéro Pièce	Rev.	16
6500MXK200905F	0	18

Parts List

This drawing is confidential and must not be reproduced or used without the consent of EXM

Ce dessin est confidentiel et ne doit pas être reproduit ou utilisé sans le consentement de EXM



TOP

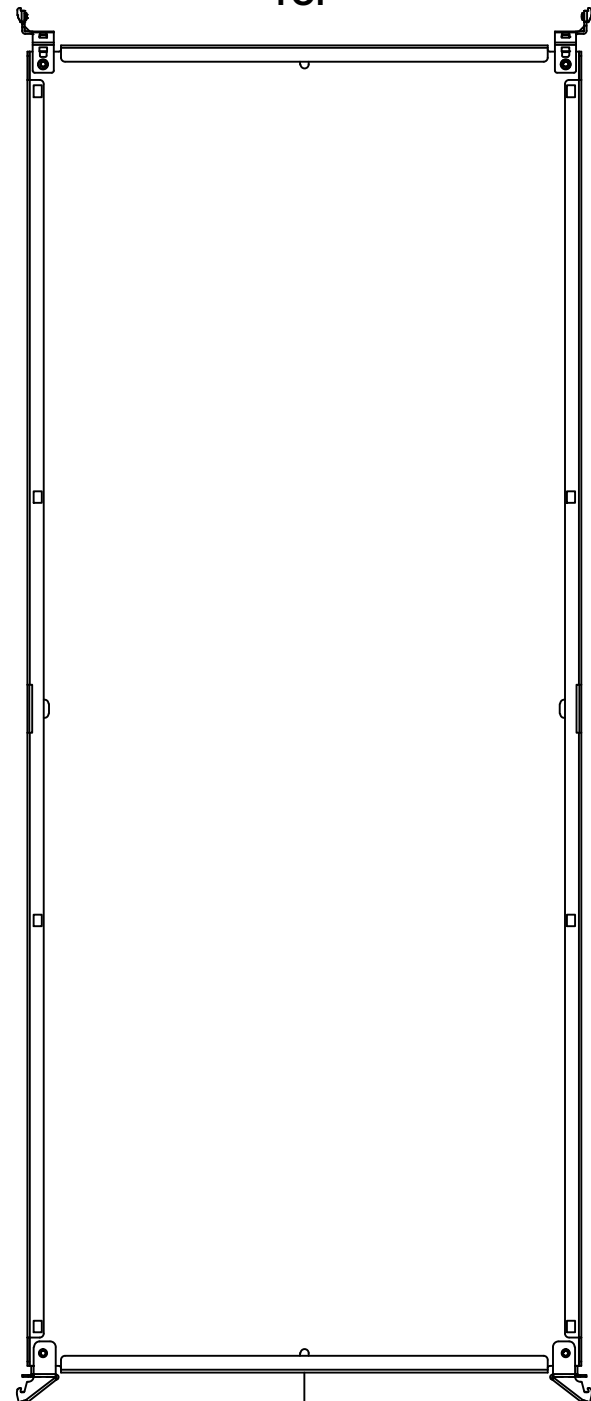

BACK

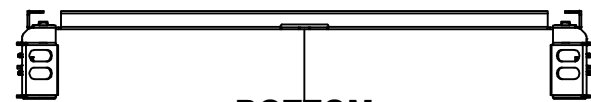

BOTTOM

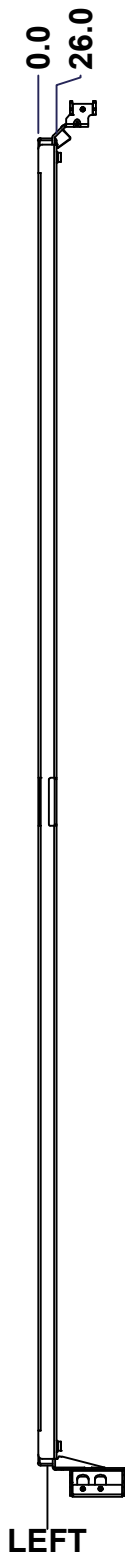

LEFT

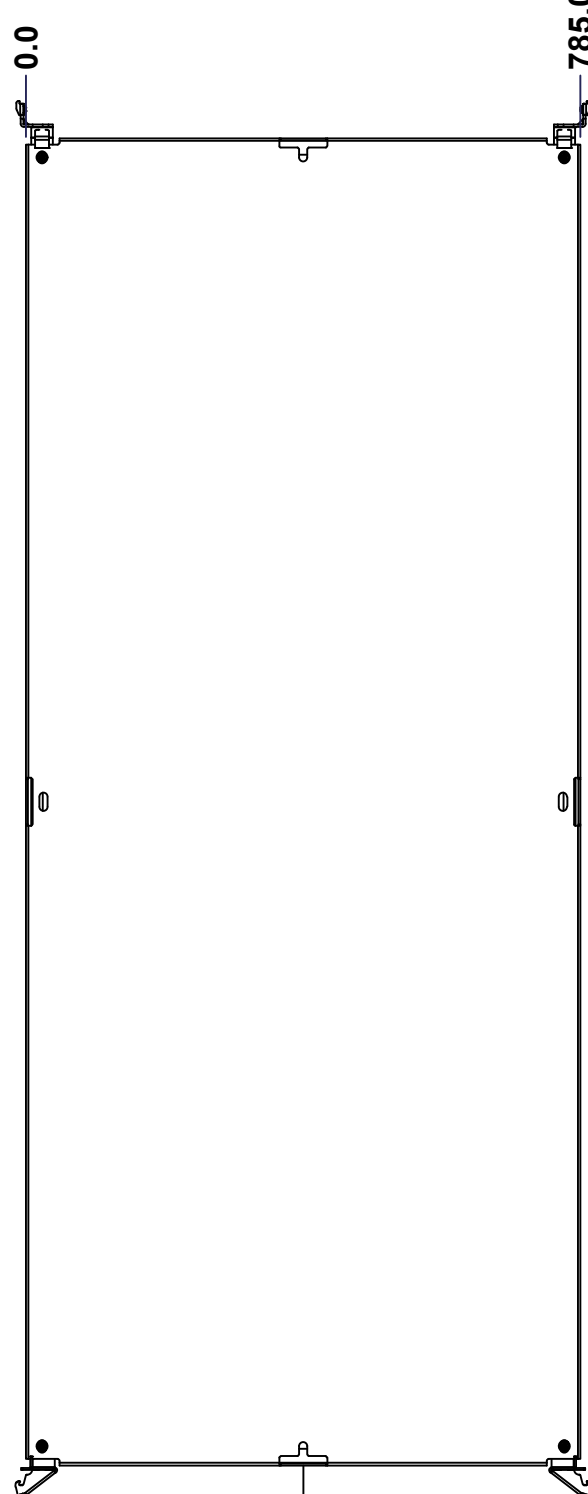

FRONT

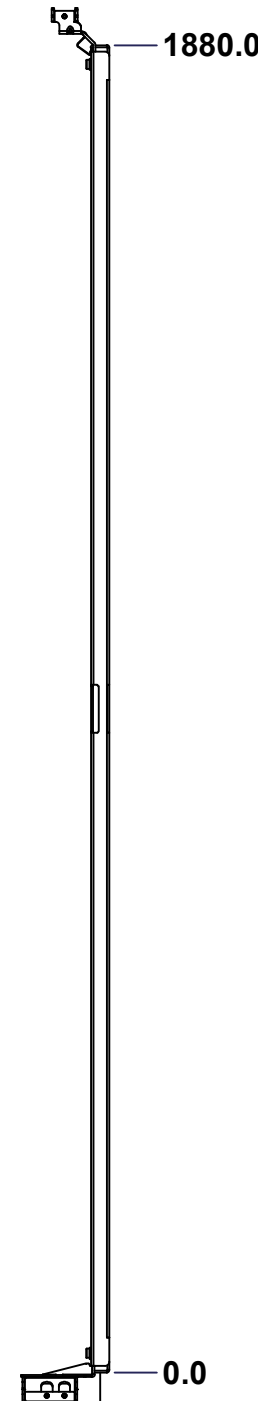

RIGHT

No.	Revisions	Date	By/Par

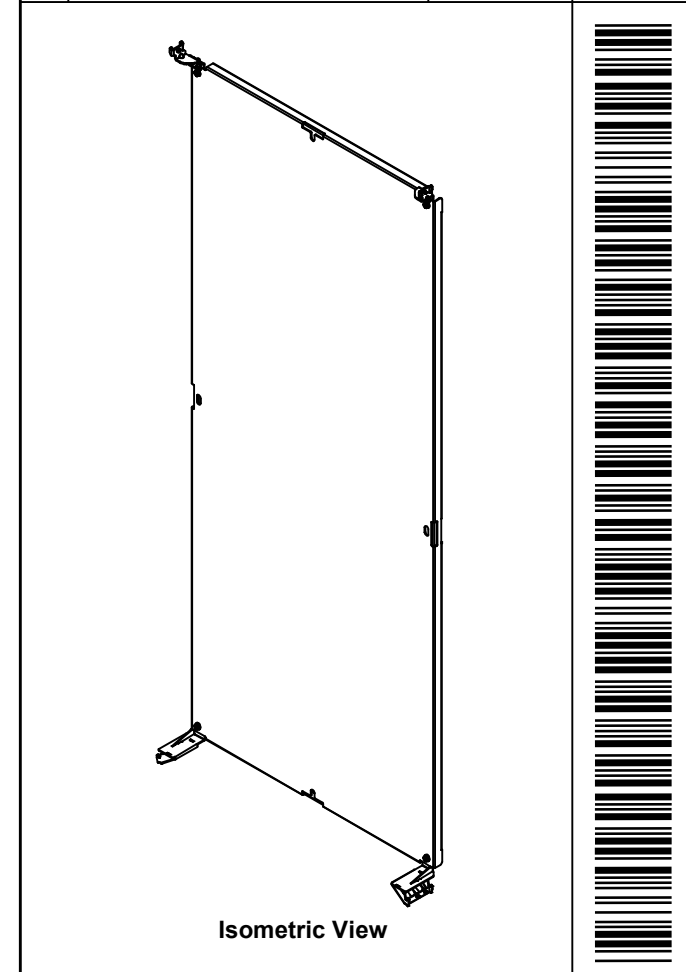

Isometric View



Tél: (450) 979-4373
 Fax: (450) 979-4626
www.exmweb.com

Flatness
Aplatissement
Max 3.0mm
Projection

Customer Client
 Drawn By Dessiné Par BoxCad: BoxCad
 Date 08-Aug-14

Material Matière 12 Ga Galvanized (2.5mm)

Color Couleur Unpainted
 Finish Fini Unpainted

Description 6500 MXM 2000mm x 900mm Back Inner Panel
 Detail Rev.

Part Number Numéro Pièce **6500MXK200905BIP**
 Rev. 0

17
18

SEE BILL OF MATERIAL ON LAST PAGE

This drawing is confidential and must not be reproduced or used without the consent of EXM

Ce dessin est confidentiel et ne doit pas être reproduit ou utilisé sans le consentement de EXM

No.	Revisions	Date	By/Par

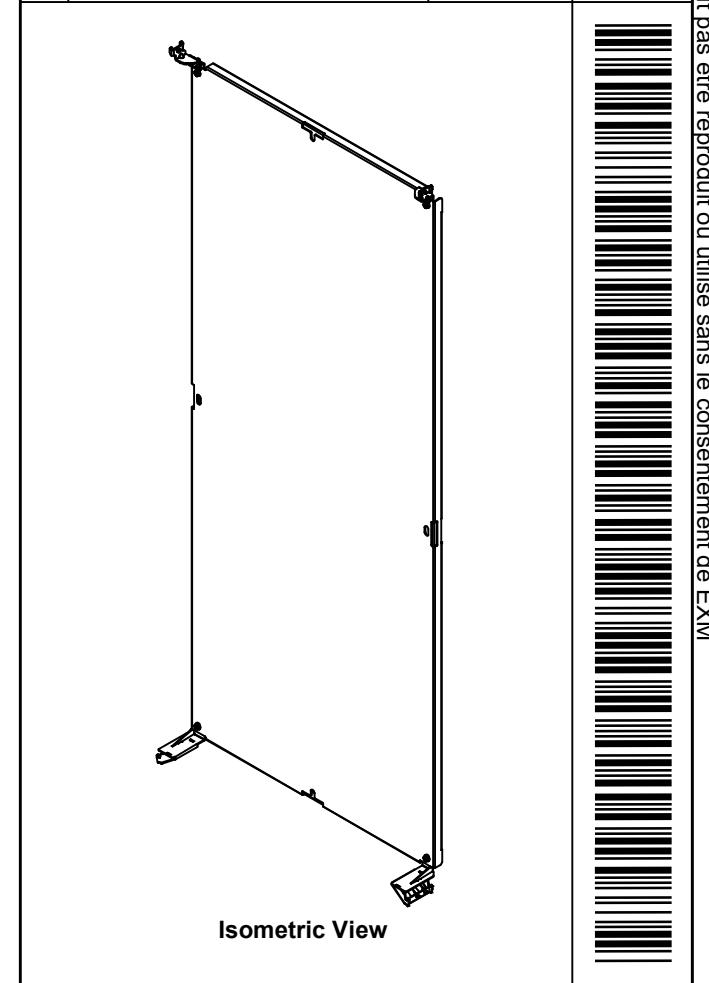

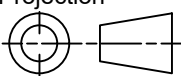
 Tél: (450) 979-4373 Fax: (450) 979-4626 www.exmweb.com		Flatness Aplatissement Max 3.0mm Projection 
Customer Client	Date	
Drawn By Dessiné Par	BoxCad: BoxCad	Date 08-Aug-14
Material Matière	12 Ga Galvanized (2.5mm)	
Color Couleur	Unpainted	Finish Fini Unpainted
Description 6500 MXM 2000mm x 900mm Back Inner Panel		Detail Rev.
Part Number Numéro Pièce	6500MXK200905BIP	Rev. 18 0 18

Qty	Part Number	Rev	Description
1	STK-A-49005	5	6500 MXM - Bottom Inner Panel Support Assembly (Right)
1	STK-A-49000	5	6500 MXM - Bottom Inner Panel Support Assembly (Left)
1	STK-A-49015	0	6500MXM - Top Inner Panel Support Kit (Right)
1	STK-A-49010	0	6500MXM - Top Inner Panel Support Kit (Left)
1	6500MXK200905BIP-P	0	6500 MXM 2000mm x 900mm Back Inner Panel Part
Parts List			