

This drawing is confidential and must not be reproduced or used without the consent of EXM

Ce dessin est confidentiel et ne doit pas être reproduit ou utilisé sans le consentement de EXM

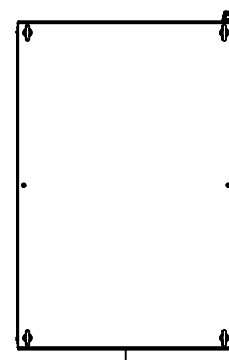

TOP

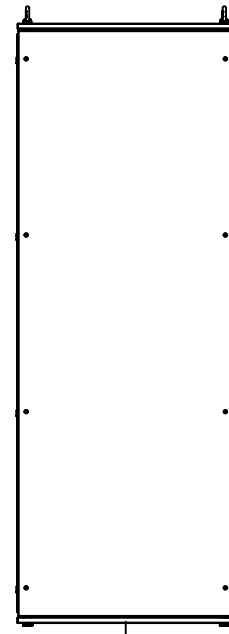

BACK

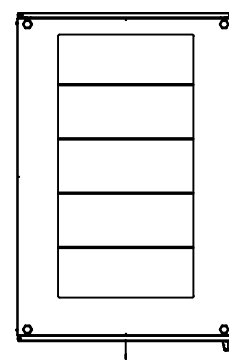

BOTTOM

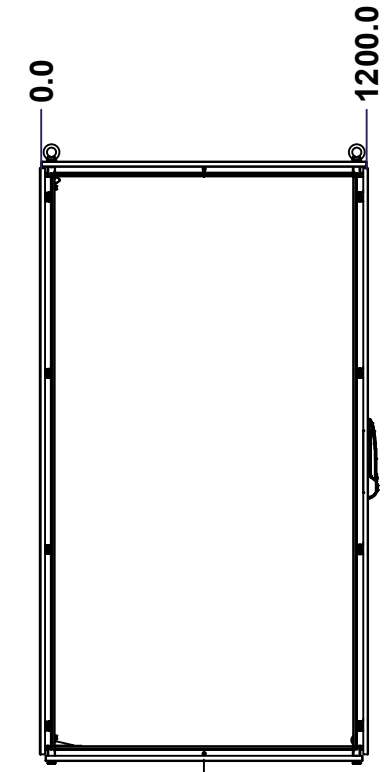

LEFT

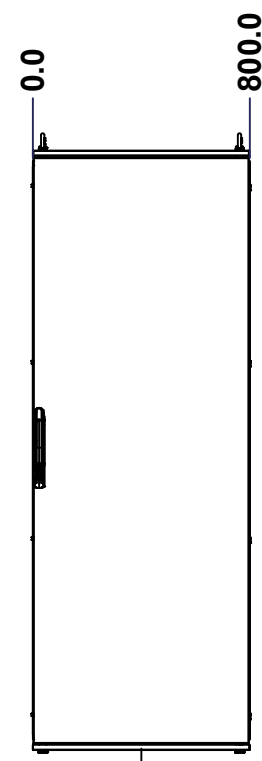

FRONT

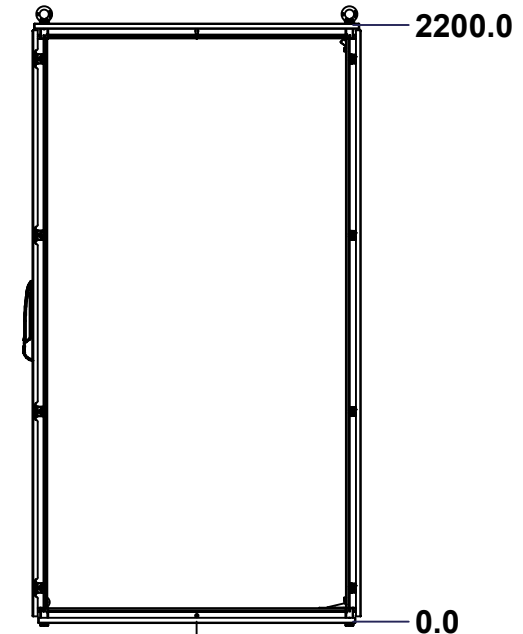

RIGHT

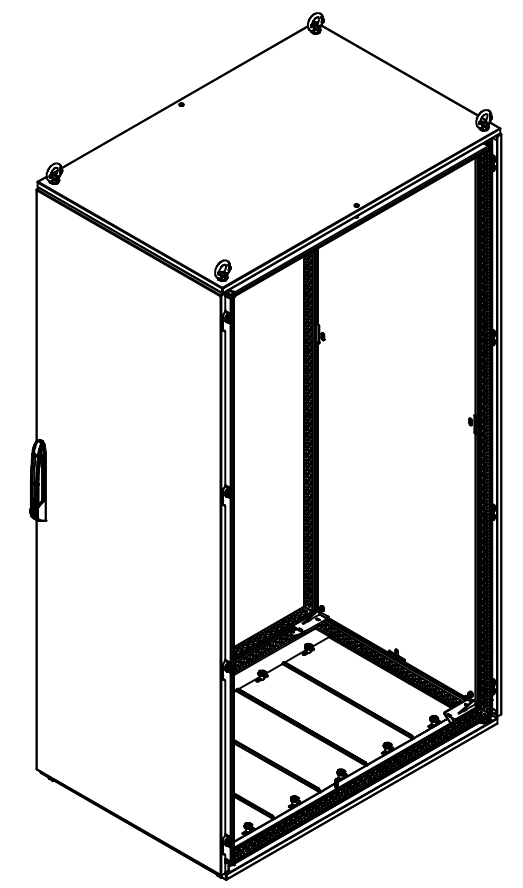

Isometric View



No.	Revisions	Date	By/Par



Tél: (450) 979-4373
 Fax: (450) 979-4626
www.exmweb.com

Flatness
Aplatissement
Max 3.0mm
Projection

Customer Client	Date
Drawn By Dessiné Par BoxCad: BoxCad	Date 22-Jan-15

Material
Matière See Part List

Color Couleur See Part List	Finish Fini See Part List
--------------------------------	------------------------------

Description
6500MX 2200mm x 800mm x 1200mm
Assembly

Part Number Numéro Pièce	Rev.	1
6500MXK220812	0	18

SEE BILL OF MATERIAL ON LAST PAGE

This drawing is confidential and must not be reproduced or used without the consent of EXM

Ce dessin est confidentiel et ne doit pas être reproduit ou utilisé sans le consentement de EXM

No.	Revisions	Date	By/Par

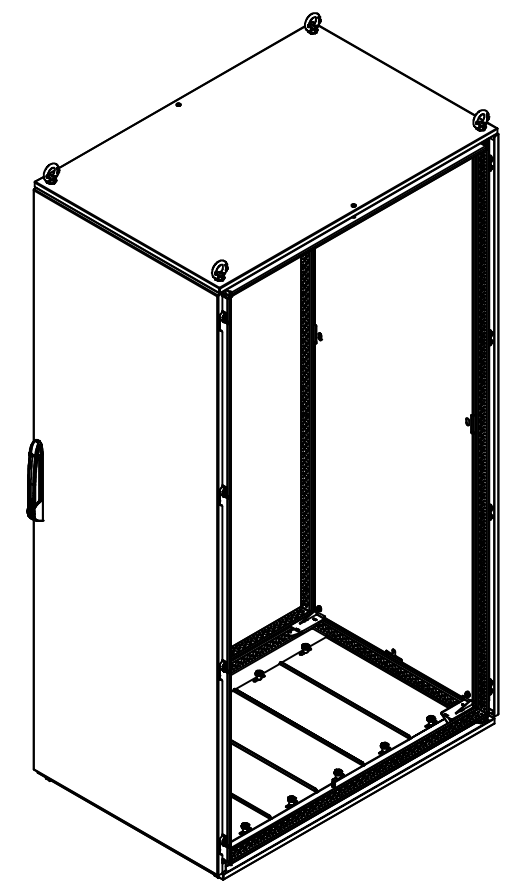

Isometric View



Tél: (450) 979-4373
 Fax: (450) 979-4626
www.exmweb.com

Flatness
Aplatissement
Max 3.0mm
Projection

Customer Client	Date
Drawn By / Dessiné Par: BoxCad: BoxCad	Date: 22-Jan-15
Material / Matière	See Part List

Color / Couleur	See Part List	Finish / Fini	See Part List
Description		Detail Rev.	
6500MX 2200mm x 800mm x 1200mm Assembly			

Part Number / Numéro Pièce	Rev.	2
6500MXK220812	0	18

Qty	Part Number	Rev	Description
1	6500MXK220812BIP	0	6500 MXM 2200mm x 800mm Back Inner Panel
1	6500MXK220812F	0	6500 MXD 2200mm x 800mm Front
1	6500MXK220812B	0	6500 MXR 2200mm x 800mm Back
1	6500MXK220812BT	0	6500 MXB 800mm x 1200mm Bottom
1	6500MXK220812T	0	6500 MXT 800mm x 1200mm Top
1	6500MXK220812FR	0	6500 MX 2200mm x 800mm x 1200mm Frame
Parts List			

This drawing is confidential and must not be reproduced or used without the consent of EXM

Ce dessin est confidentiel et ne doit pas être reproduit ou utilisé sans le consentement de EXM

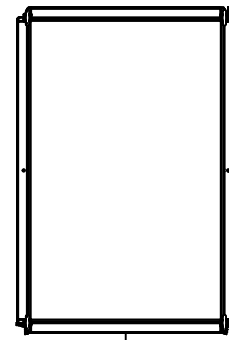

TOP

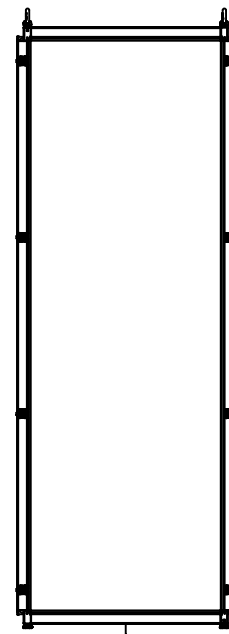

BACK

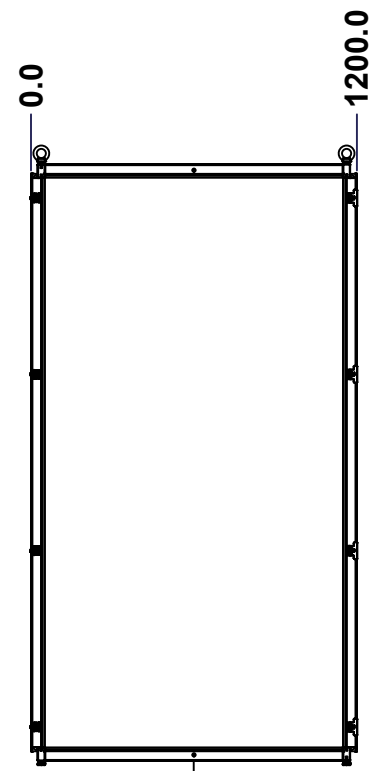

LEFT

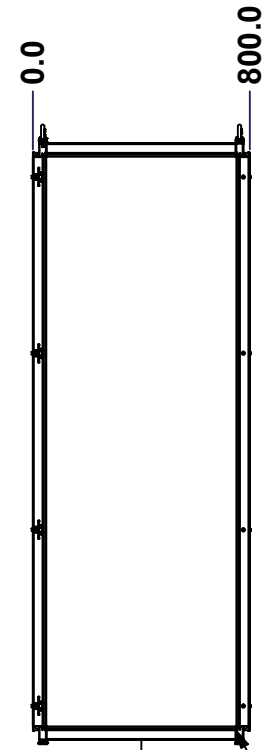

FRONT

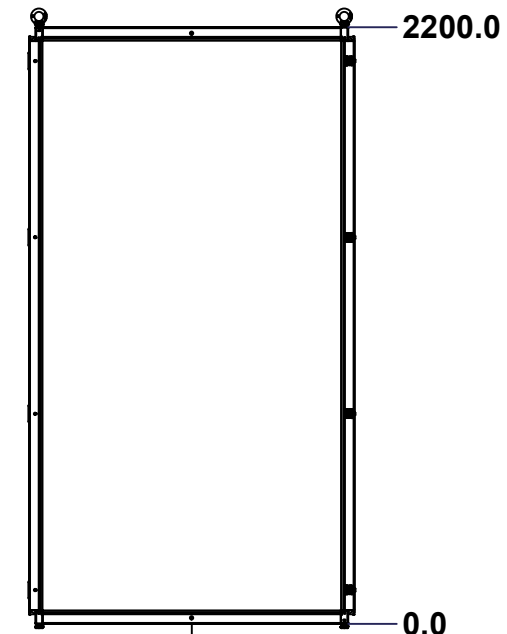

RIGHT

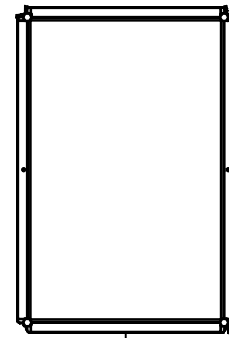

BOTTOM

Grind excess weld off corner(s)

No.	Revisions	Date	By/Par

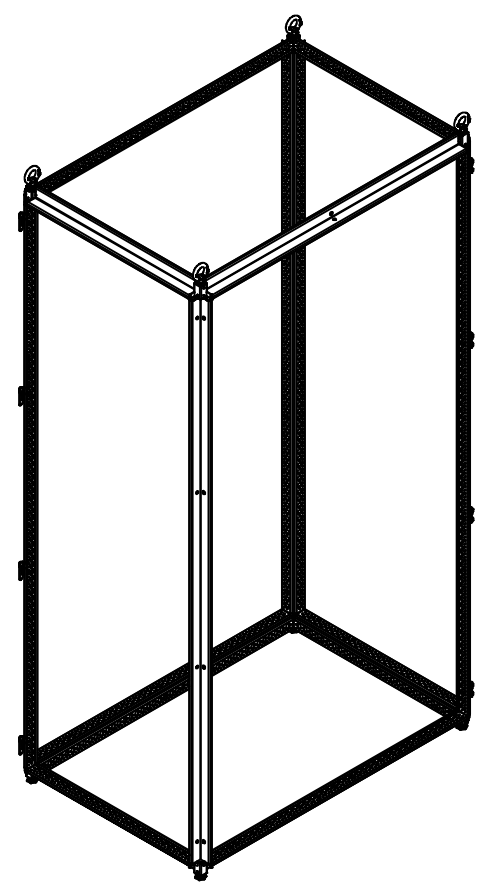

Isometric View

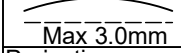
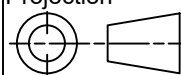

 Tél: (450) 979-4373 Fax: (450) 979-4626 www.exmweb.com		Flatness Aplatissement  Max 3.0mm Projection 
Customer Client		Date
Drawn By Dessiné Par	BoxCad: BoxCad	Date 22-Jan-15
Material Matière	16 Ga Electro-Galvanized (1.4mm)	
Color Couleur	Iron Grey RAL7011	Finish Fini Textured
Description 6500 MX 2200mm x 800mm x 1200mm Frame		Detail Rev.
Part Number Numéro Pièce	6500MXK220812FR	Rev. 3 0

SEE BILL OF MATERIAL ON LAST PAGE

This drawing is confidential and must not be reproduced or used without the consent of EXM

Ce dessin est confidentiel et ne doit pas être reproduit ou utilisé sans le consentement de EXM

No.	Revisions	Date	By/Par

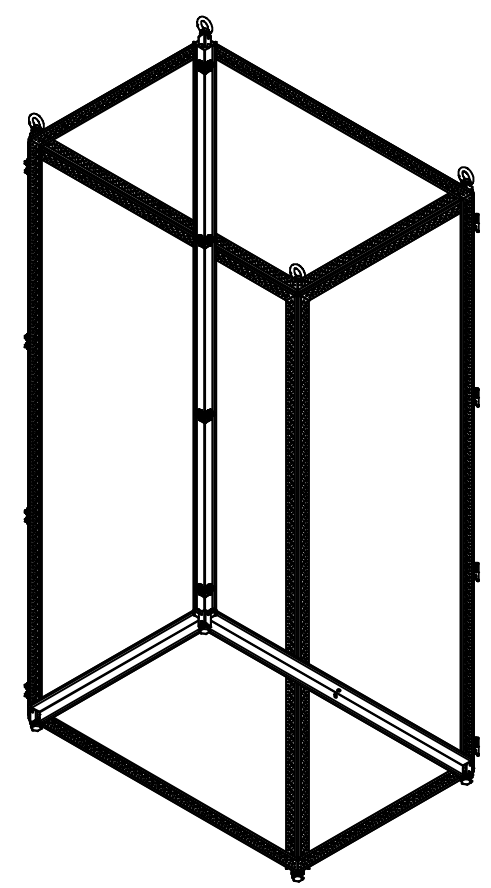

Isometric View



Tél: (450) 979-4373
 Fax: (450) 979-4626
www.exmweb.com

Flatness
Aplatissement
Max 3.0mm
Projection

1	STK-P-03810ST	0	Powder Paint (Iron Grey /Sand Textured)
4	STK-Q-47250-08	6	6500 MX 800mm Horizontal Frame Post Part
4	STK-Q-47250-12	6	6500 MX 1200mm Horizontal Frame Post Part
4	STK-A-70589	9	6500 MX Fixed Side Panel Bracket Assembly
22	STK-Q-77120	1	6500MX-Frame Rubber Plug
8	STK-A-70580	9	Mtrx Bracket
8	STK-Q-00610	3	M16 x 30.0mm Bolt
8	STK-A-49448	6	6500 MX - Frame Sheet Metal Corner Assembly
4	STK-Q-49500	3	M12 Eye Bolt (0.34T)
4	STK-Q-61110	0	M12 Feet Leveler
4	STK-Q-47251-22	6	6500 MX 2200mm Vertical Frame Post Part

Customer Client	Date
Drawn By Dessiné Par BoxCad: BoxCad	Date 22-Jan-15
Material Matière	16 Ga Electro-Galvanized (1.4mm)
Color Couleur Iron Grey RAL7011	Finish Fini Textured
Description 6500 MX 2200mm x 800mm x 1200mm Frame	Detail Rev.
Part Number Numéro Pièce	Rev. 4

Qty	Part Number	Rev	Description
Parts List			

6500MXK220812FR

0

18

This drawing is confidential and must not be reproduced or used without the consent of EXM

Ce dessin est confidentiel et ne doit pas être reproduit ou utilisé sans le consentement de EXM



TOP

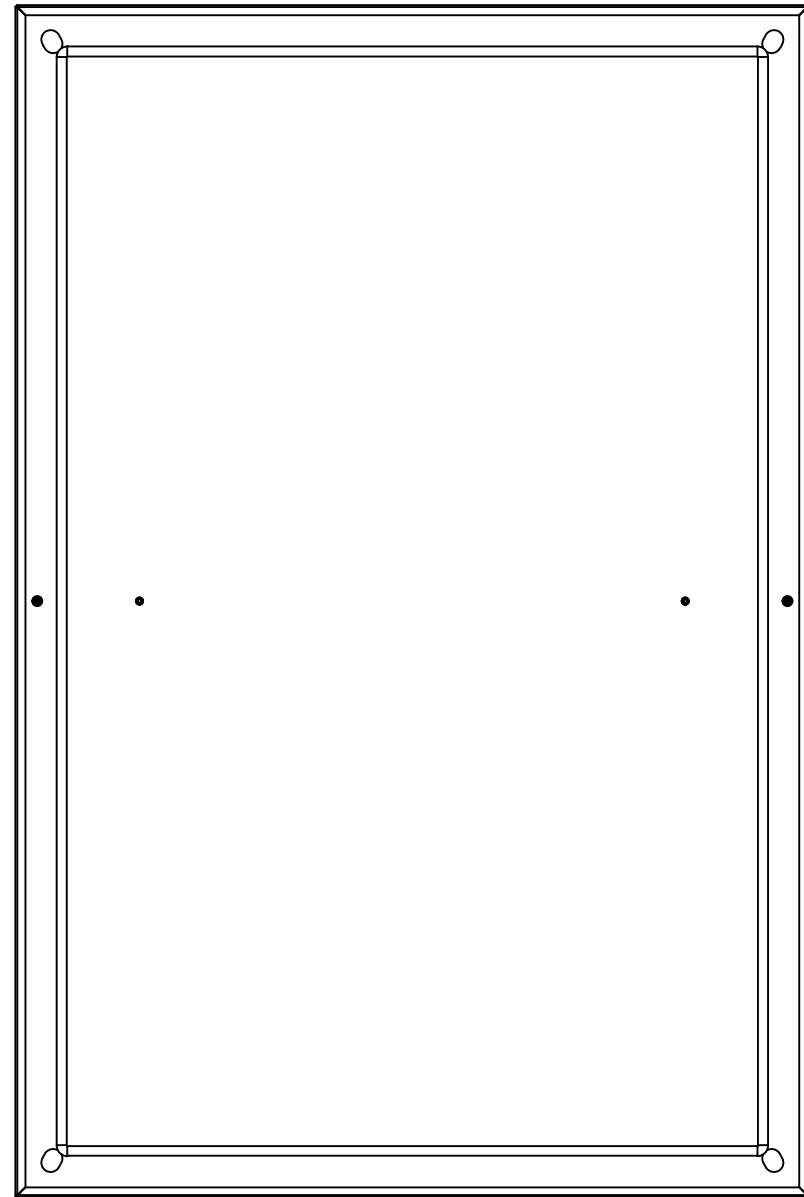

BACK



BOTTOM

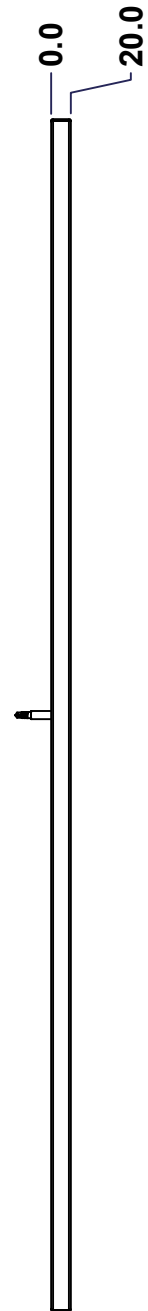

LEFT

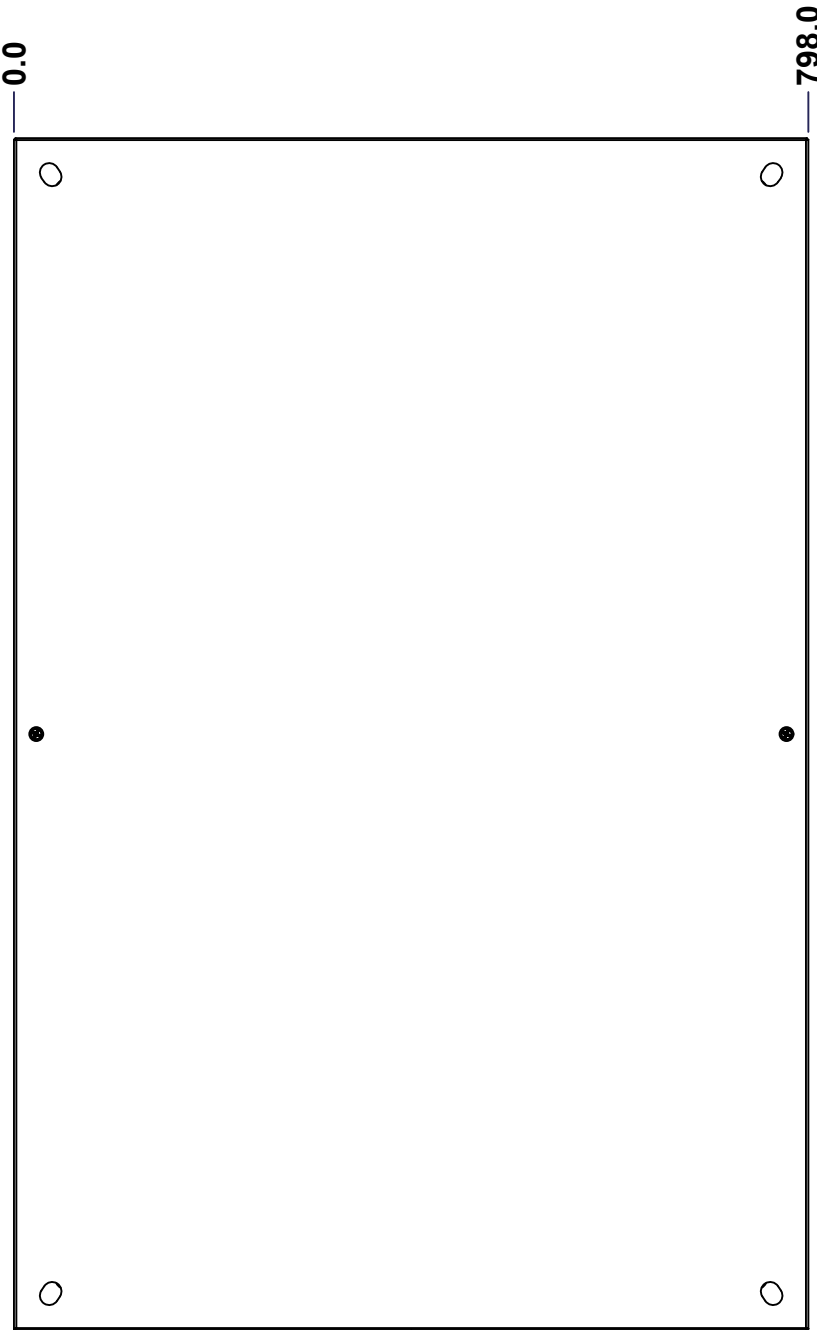

FRONT

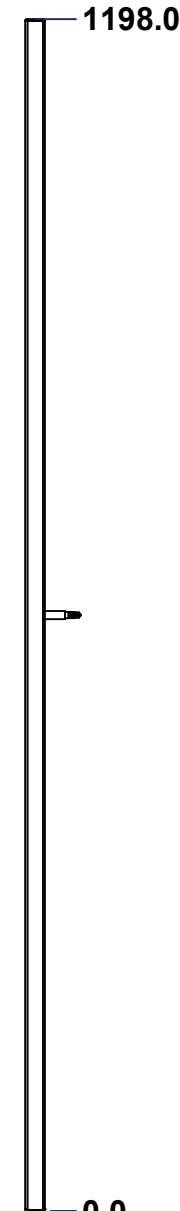

RIGHT

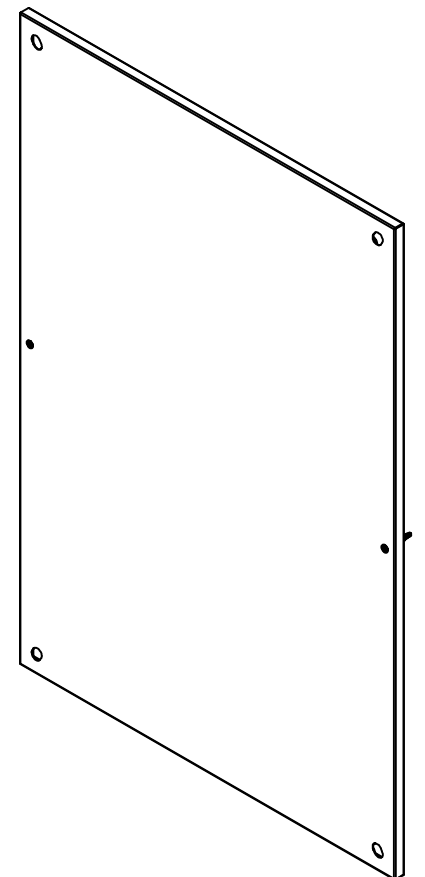

Isometric View

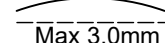
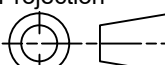

No.	Revisions	Date	By/Par

 Tél: (450) 979-4373 Fax: (450) 979-4626 www.exmweb.com		Flatness Aplatissement  Max 3.0mm
Customer Client Date		Projection 
Drawn By Dessiné Par BoxCad: BoxCad		Date 22-Jan-15
Material Matière 16 Ga Cold Rolled A1008 CS Type B		
Color Couleur Iron Grey RAL7011	Finish Fini Textured	
Description 6500 MXT 800mm x 1200mm Top		Detail Rev.
Part Number Numéro Pièce 6500MXK220812T		Rev. 5 0

Use gasket program path 6500 MX > 6500 MXT

SEE BILL OF MATERIAL ON LAST PAGE

This drawing is confidential and must not be reproduced or used without the consent of EXM

Ce dessin est confidentiel et ne doit pas être reproduit ou utilisé sans le consentement de EXM

STANDARD FEATURES ARE NOT LISTED IN THIS HOLE TABLE			
HOLE TABLE - FRONT VIEW (CUSTOM FEATURE ONLY)			
CUT-OUT	XDIM	YDIM	DESCRIPTION
1	125.0	599.0	GND STUD M6 x 18mm (Inside)
2	673.0	599.0	GND STUD M6 x 18mm (Inside)

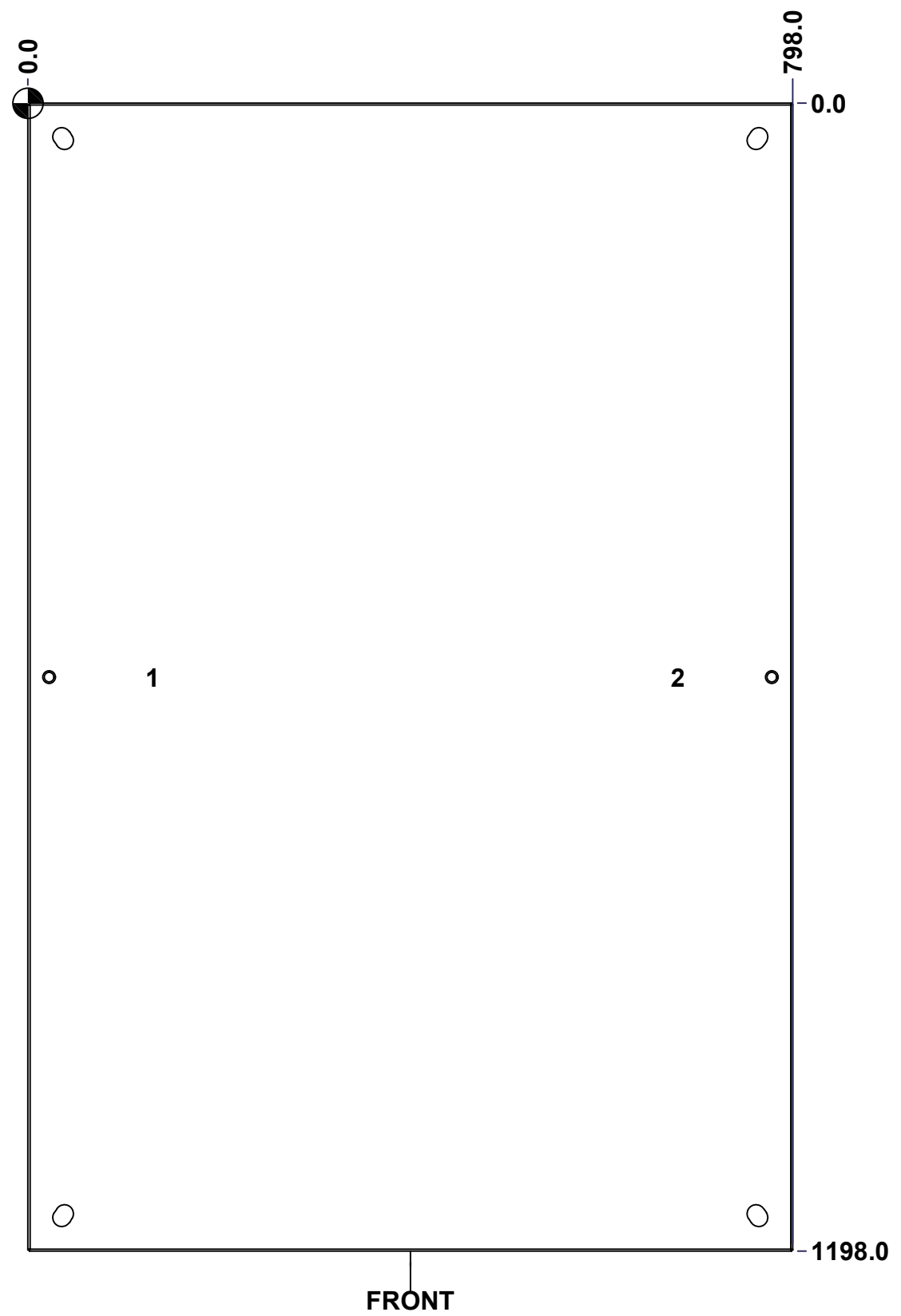

Use bending program path 6500 MX > 6500 MXT

	Description		Status
	6500 MXT 800mm x 1200mm Top		(NULL)
	Part Number Numéro Pièce		Rev.
	6500MXK220812T		6
			18

This drawing is confidential and must not be reproduced or used without the consent of EXM

Ce dessin est confidentiel et ne doit pas être reproduit ou utilisé sans le consentement de EXM

No.	Revisions	Date	By/Par

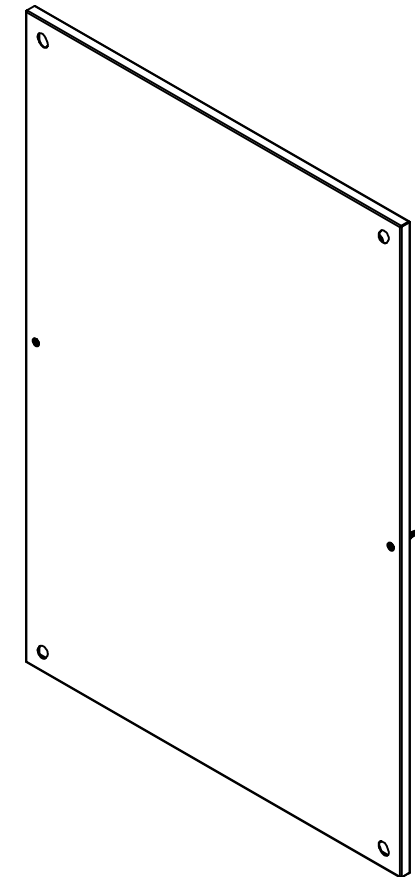

Isometric View

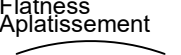
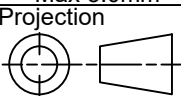

 Tél: (450) 979-4373 Fax: (450) 979-4626 www.exmweb.com		Flatness Aplatissement  Max 3.0mm
Customer Client Drawn By / Dessiné Par: BoxCad: BoxCad		Projection  Date: 22-Jan-15
Material / Matière: 16 Ga Cold Rolled A1008 CS Type B		
Color / Couleur: Iron Grey RAL7011	Finish / Fini: Textured	
Description: 6500 MXT 800mm x 1200mm Top		Detail Rev.
Part Number / Numéro Pièce: 6500MXK220812T		Rev. 7 / 18

Qty	Part Number	Rev	Description
1	STK-P-03810ST	0	Powder Paint (Iron Grey /Sand Textured)
2	STK-Q-16055	1	M6 x 18mm Stud (No Paint Cap Required)
2	STK-Q-90227	1	Flat Head Drilling Screw M6.3 x 56.0mm Long
1	6500MXK220812TG	0	6500 MXT 800mm x 1200mm Top Gasket
1	6500MXK220812T-P	0	6500 MXT 800mm x 1200mm Top Part
Parts List			

This drawing is confidential and must not be reproduced or used without the consent of EXM

Ce dessin est confidentiel et ne doit pas être reproduit ou utilisé sans le consentement de EXM

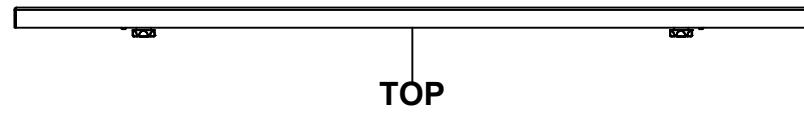

TOP

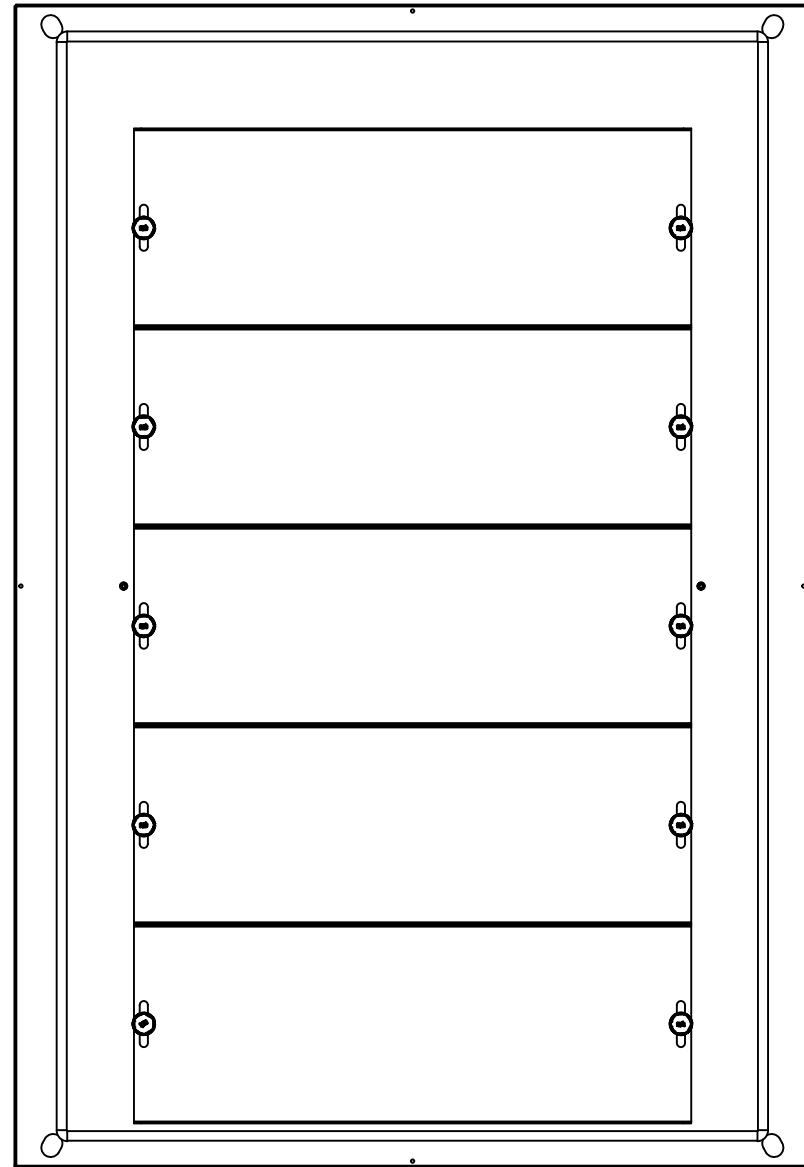

BACK

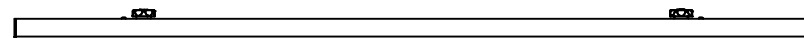

BOTTOM

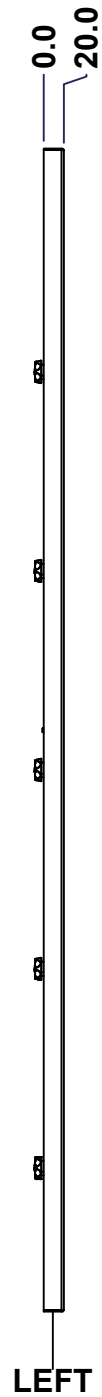

LEFT

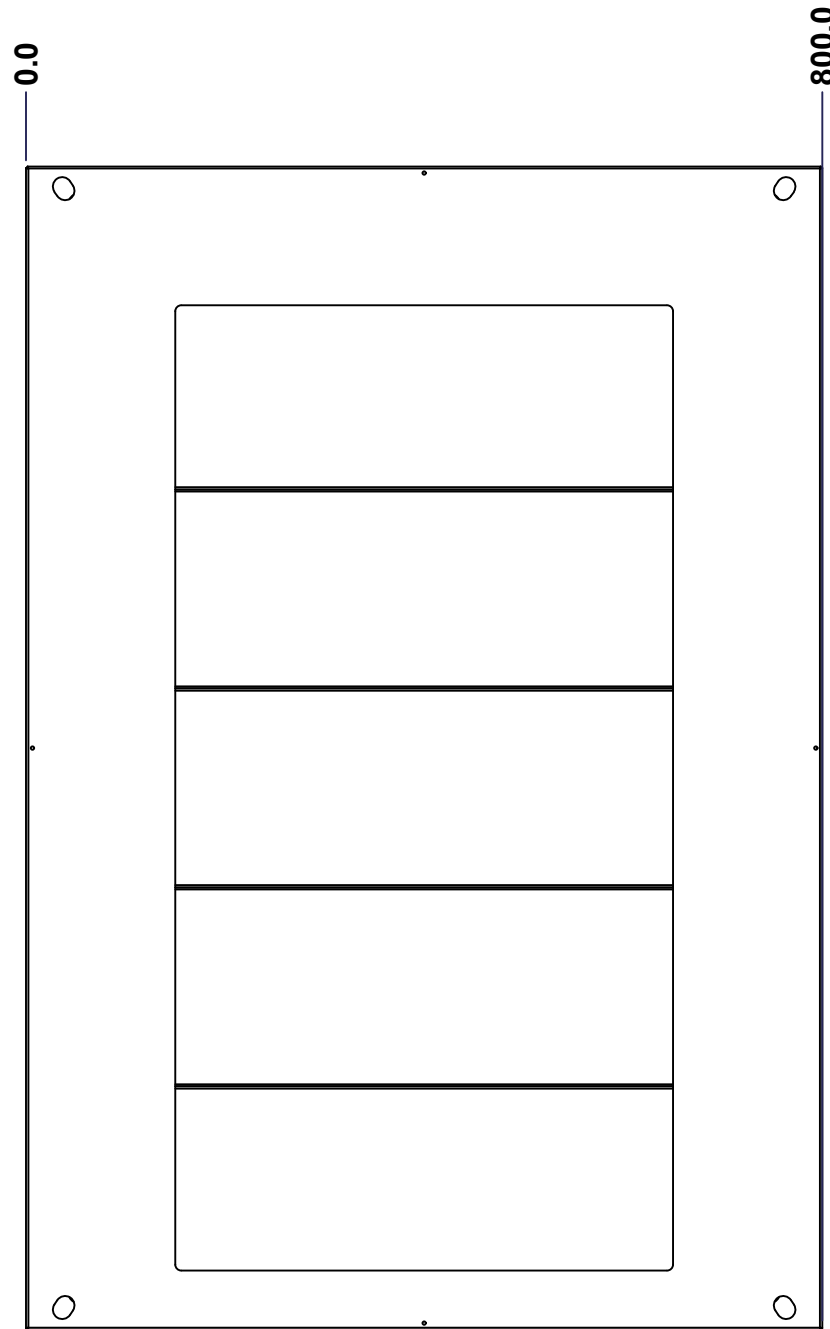

FRONT

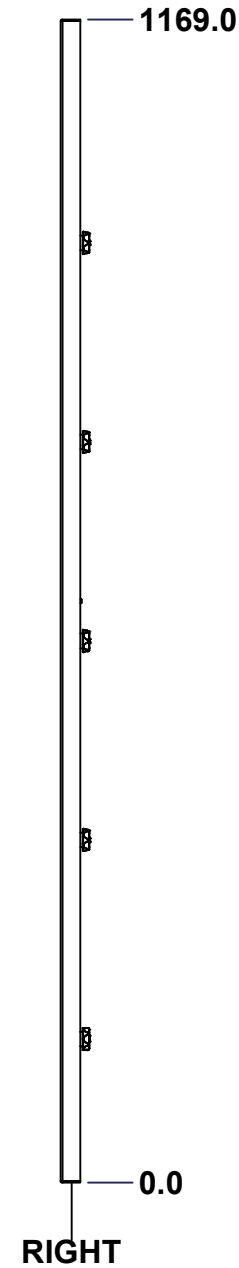

RIGHT

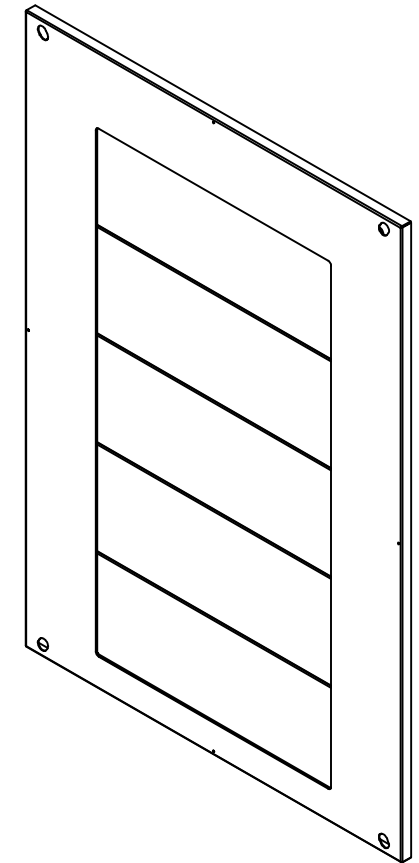

Isometric View

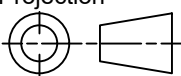

No.	Revisions	Date	By/Par

 Tél: (450) 979-4373 Fax: (450) 979-4626 www.exmweb.com		Flatness Aplatissement Max 3.0mm Projection 
Customer Client	Date	
Drawn By Dessiné Par	BoxCad: BoxCad	Date 22-Jan-15
Material Matière	16 Ga Cold Rolled A1008 CS Type B	
Color Couleur	Iron Grey RAL7011	Finish Fini Textured
Description	Detail Rev.	
6500 MXB 800mm x 1200mm Bottom		
Part Number Numéro Pièce	Rev.	8
6500MXK220812BT	0	18

Use gasket program path 6500 MX > 6500MXB

SEE BILL OF MATERIAL ON LAST PAGE

This drawing is confidential and must not be reproduced or used without the consent of EXM

Ce dessin est confidentiel et ne doit pas être reproduit ou utilisé sans le consentement de EXM

STANDARD FEATURES ARE NOT LISTED IN THIS HOLE TABLE

HOLE TABLE - FRONT VIEW (CUSTOM FEATURE ONLY)

CUT-OUT	XDIM	YDIM	DESCRIPTION
1	110.0	584.5	GND STUD M6 x 18mm (Inside)
2	690.0	584.5	GND STUD M6 x 18mm (Inside)
3	130.0	944.5	GP STUD M6 x 18mm (Inside)
4	670.0	944.5	GP STUD M6 x 18mm (Inside)
5	130.0	744.5	GP STUD M6 x 18mm (Inside)
6	670.0	744.5	GP STUD M6 x 18mm (Inside)
7	130.0	544.5	GP STUD M6 x 18mm (Inside)
8	670.0	544.5	GP STUD M6 x 18mm (Inside)
9	130.0	344.5	GP STUD M6 x 18mm (Inside)
10	670.0	344.5	GP STUD M6 x 18mm (Inside)
11	130.0	144.5	GP STUD M6 x 18mm (Inside)
12	670.0	144.5	GP STUD M6 x 18mm (Inside)

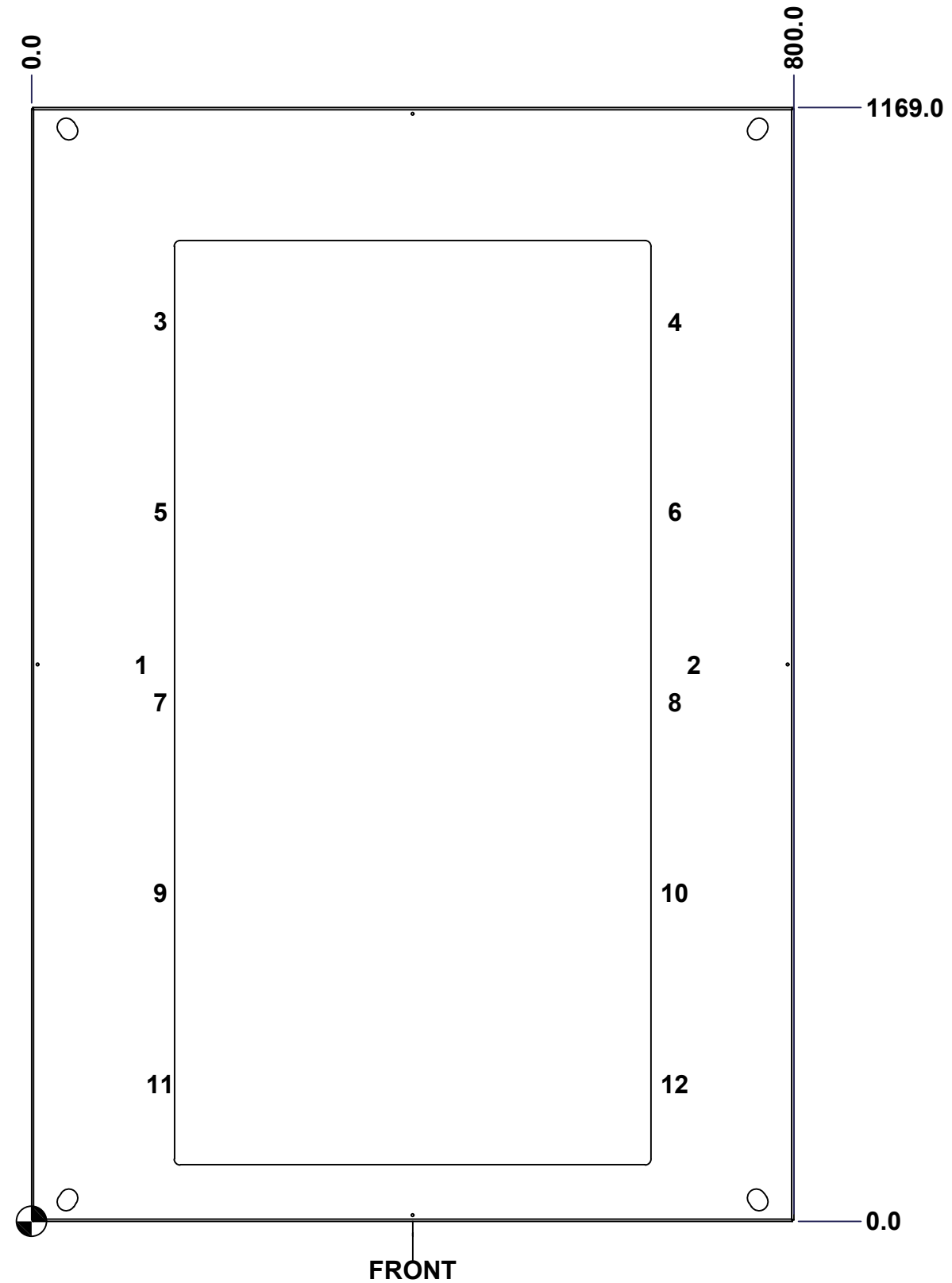

Use bending program path 6500 MX > 6500MXB

	Description		Status
	6500 MXB 800mm x 1200mm Bottom		(NULL)
	Part Number Numéro Pièce		Rev.
	6500MXK220812BT		0 / 9
			18

This drawing is confidential and must not be reproduced or used without the consent of EXM

Ce dessin est confidentiel et ne doit pas être reproduit ou utilisé sans le consentement de EXM

No.	Revisions	Date	By/Par

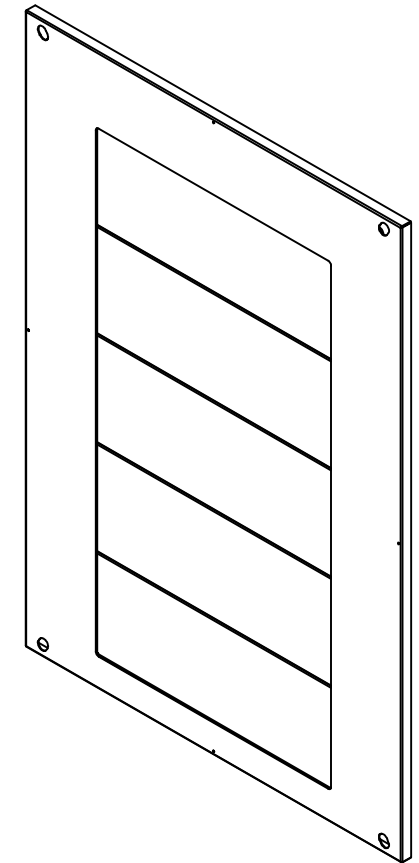

Isometric View

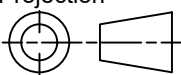

 Tél: (450) 979-4373 Fax: (450) 979-4626 www.exmweb.com	Flatness Aplatissement	Max 3.0mm
	Projection	
Customer Client	Date	
Drawn By Dessiné Par	BoxCad: BoxCad	Date 22-Jan-15
Material Matière	16 Ga Cold Rolled A1008 CS Type B	
Color Couleur	Iron Grey RAL7011	Finish Fini Textured
Description	Detail Rev.	
6500 MXB 800mm x 1200mm Bottom		
Part Number Numéro Pièce	Rev.	10
6500MXK220812BT	0	18

Qty	Part Number	Rev	Description
1	STK-P-03810ST	0	Powder Paint (Iron Grey /Sand Textured)
10	STK-Q-06001	0	Mtrx - Gland Plate M6 Plastic Thumb Nut
12	STK-Q-16055	1	M6 x 18mm Stud (No Paint Cap Required)
5	6500MXK220812GP200-P	0	6500 MXB 800mm Gland Plate Part (200mm)
1	6500MXK220812BTGPG	0	6500 MXB 800mm x 1200mm Bottom Gland Plate Gasket
1	6500MXK220812BTG	0	6500 MXB 800mm x 1200mm Bottom Gasket
1	6500MXK220812BT-P	0	6500 MXB 800mm x 1200mm Bottom Part
Parts List			

This drawing is confidential and must not be reproduced or used without the consent of EXM

Ce dessin est confidentiel et ne doit pas être reproduit ou utilisé sans le consentement de EXM

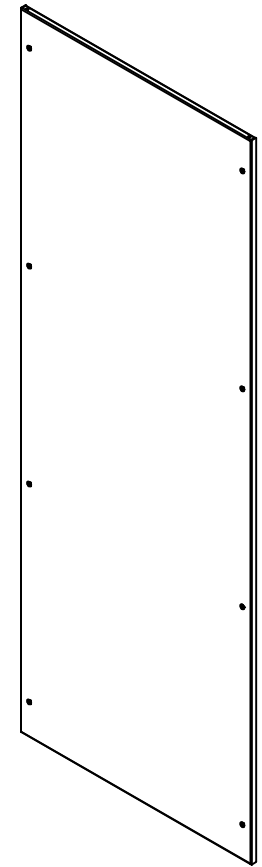
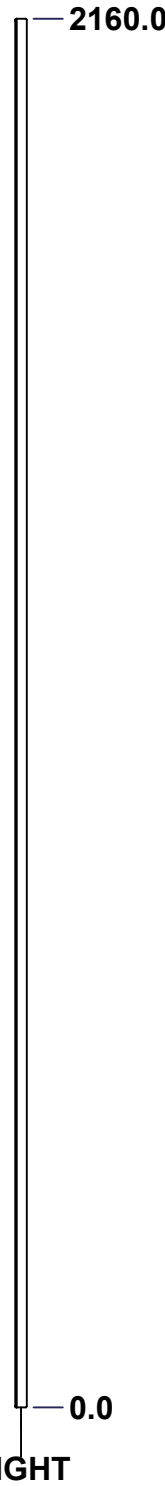
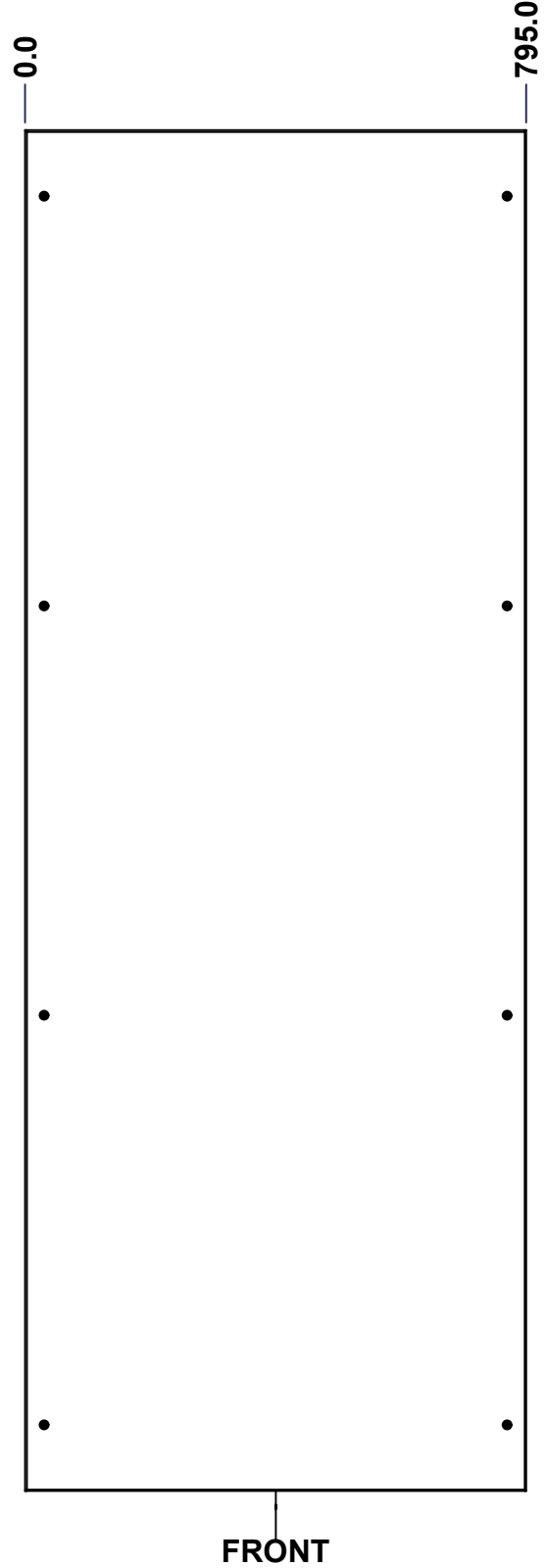
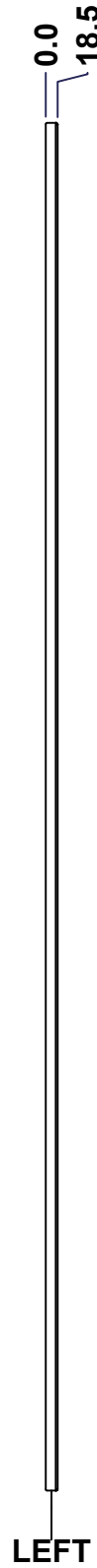
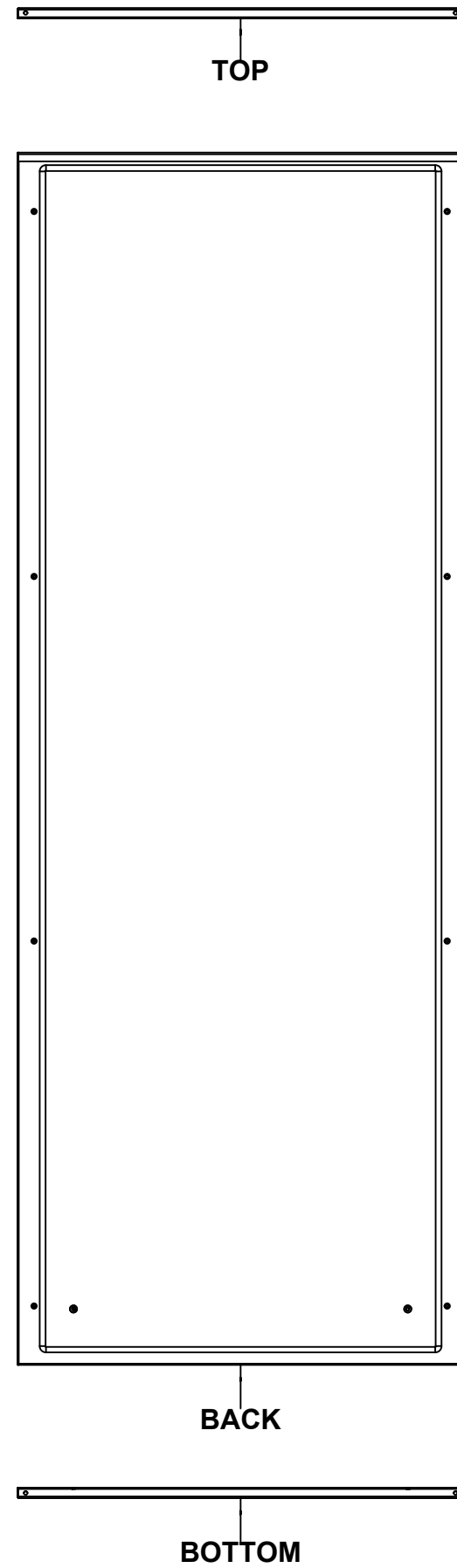

No.	Revisions	Date	By/Par



Tél: (450) 979-4373
 Fax: (450) 979-4626
www.exmweb.com

Flatness
Aplatissement
Max 3.0mm

Projection

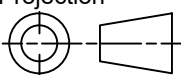

Customer Client	Date
Drawn By / Dessiné Par: BoxCad: BoxCad	Date: 22-Jan-15
Material / Matière: 14 Ga Cold Rolled A1008 CS Type B	
Color / Couleur: Light Grey RAL7035	Finish / Fini: Textured
Description: 6500 MXR 2200mm x 800mm Back	Detail Rev.
Part Number / Numéro Pièce: 6500MXK220812B	Rev. 0
	11 / 18

Use gasket program path 6500 MX > 6500 MXR

SEE BILL OF MATERIAL ON LAST PAGE

This drawing is confidential and must not be reproduced or used without the consent of EXM

Ce dessin est confidentiel et ne doit pas être reproduit ou utilisé sans le consentement de EXM

STANDARD FEATURES ARE NOT LISTED IN THIS HOLE TABLE			
HOLE TABLE - FRONT VIEW (CUSTOM FEATURE ONLY)			
CUT-OUT	XDIM	YDIM	DESCRIPTION
1	100.0	100.0	GND STUD M6 x 16mm (Inside)
2	695.0	100.0	GND STUD M6 x 16mm (Inside)

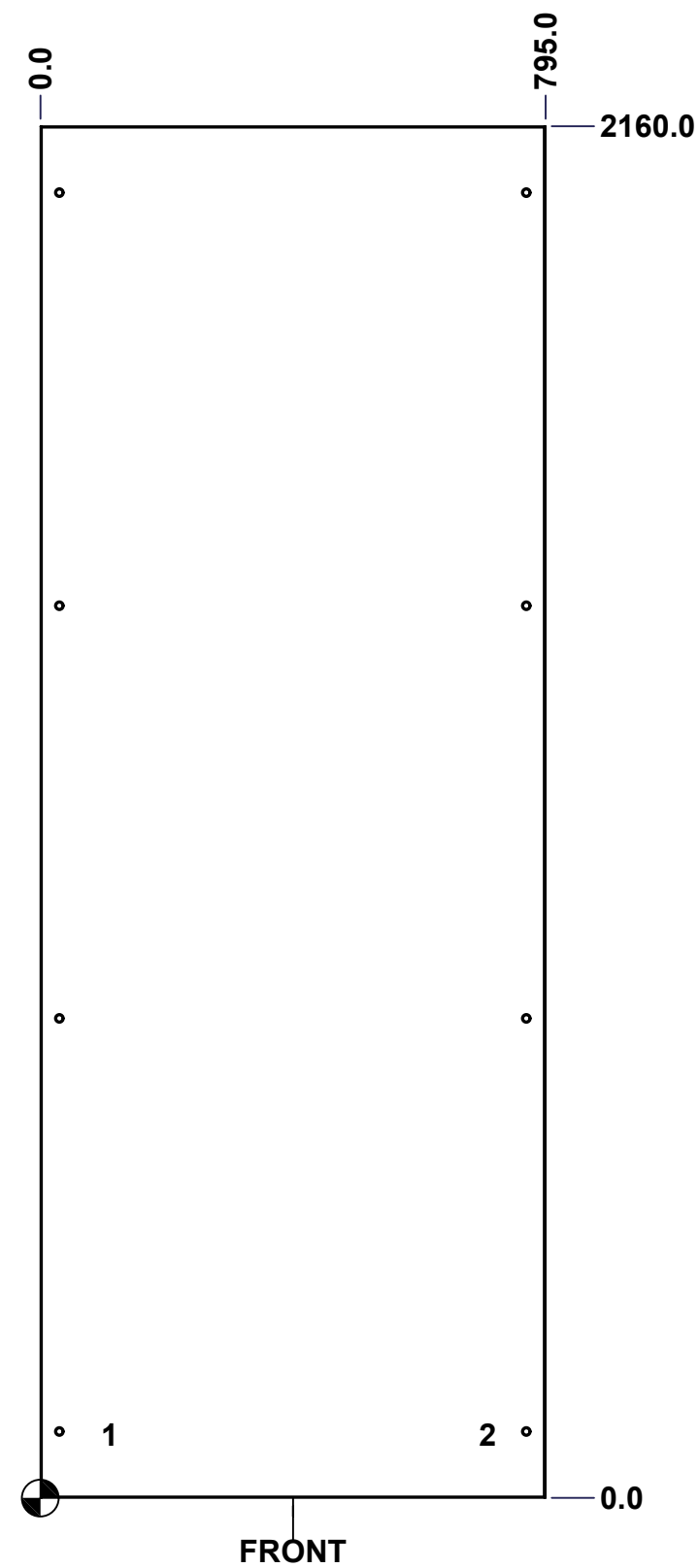

Use bending program path 6500 MX > 6500 MXR

	Description	Status
	6500 MXR 2200mm x 800mm Back	(NULL)
	Part Number Numéro Pièce	Rev.
	6500MXK220812B	0
		12
		18

This drawing is confidential and must not be reproduced or used without the consent of EXM

Ce dessin est confidentiel et ne doit pas être reproduit ou utilisé sans le consentement de EXM

No.	Revisions	Date	By/Par

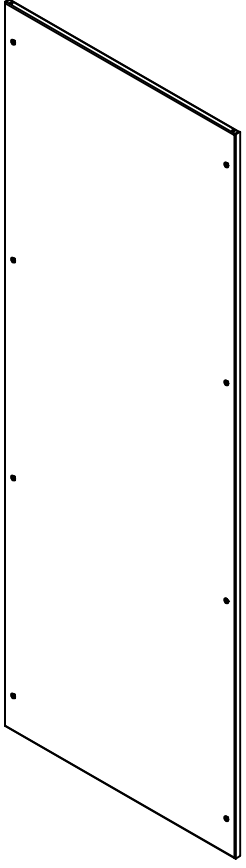

Isometric View

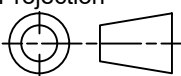

		Tél: (450) 979-4373 Fax: (450) 979-4626 www.exmweb.com		Flatness Aplatissement Max 3.0mm	
Customer Client		Date		Projection 	
Drawn By / Dessiné Par: BoxCad: BoxCad		Date: 22-Jan-15		Material / Matière: 14 Ga Cold Rolled A1008 CS Type B	
Color / Couleur: Light Grey RAL7035		Finish / Fini: Textured		Description: 6500 MXR 2200mm x 800mm Back	
Part Number / Numéro Pièce: 6500MXK220812B		Rev. / Révis: 0		Detail Rev. / Révis: 13 / 18	

Qty	Part Number	Rev	Description
1	STK-P-03820R	0	Powder Paint (Light Grey / Rough Textured)
1	6500MXK220812BG	0	6500 MXR 2200mm x 800mm Back Gasket
8	STK-Q-03071	0	M6 x 16mm Machine Screw
2	STK-Q-16080	0	Ground Stud M6 x 16mm Steel
1	6500MXK220812B-P	0	6500 MXR 2200mm x 800mm Back Part
Parts List			

This drawing is confidential and must not be reproduced or used without the consent of EXM

Ce dessin est confidentiel et ne doit pas être reproduit ou utilisé sans le consentement de EXM

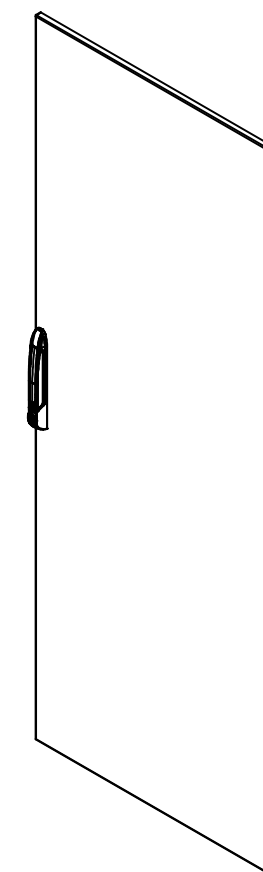
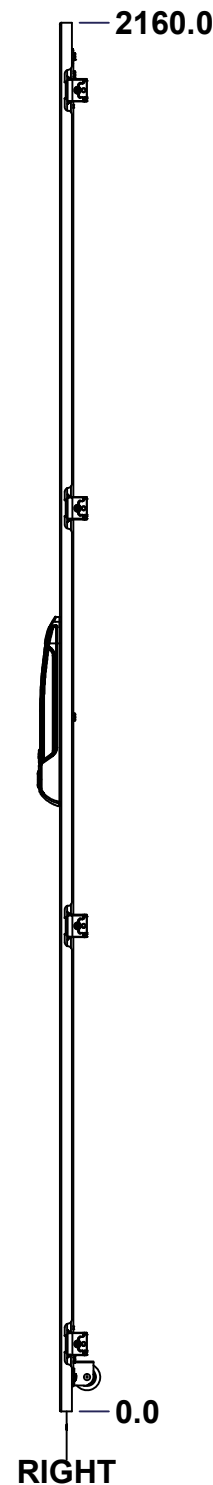
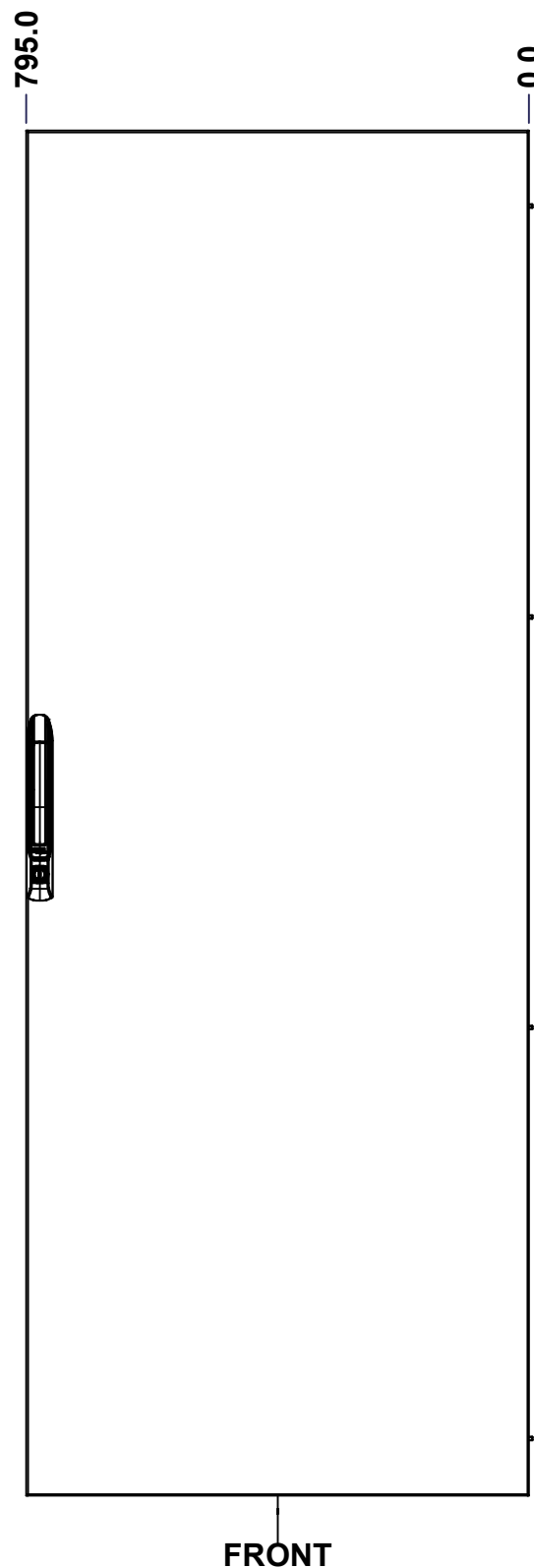
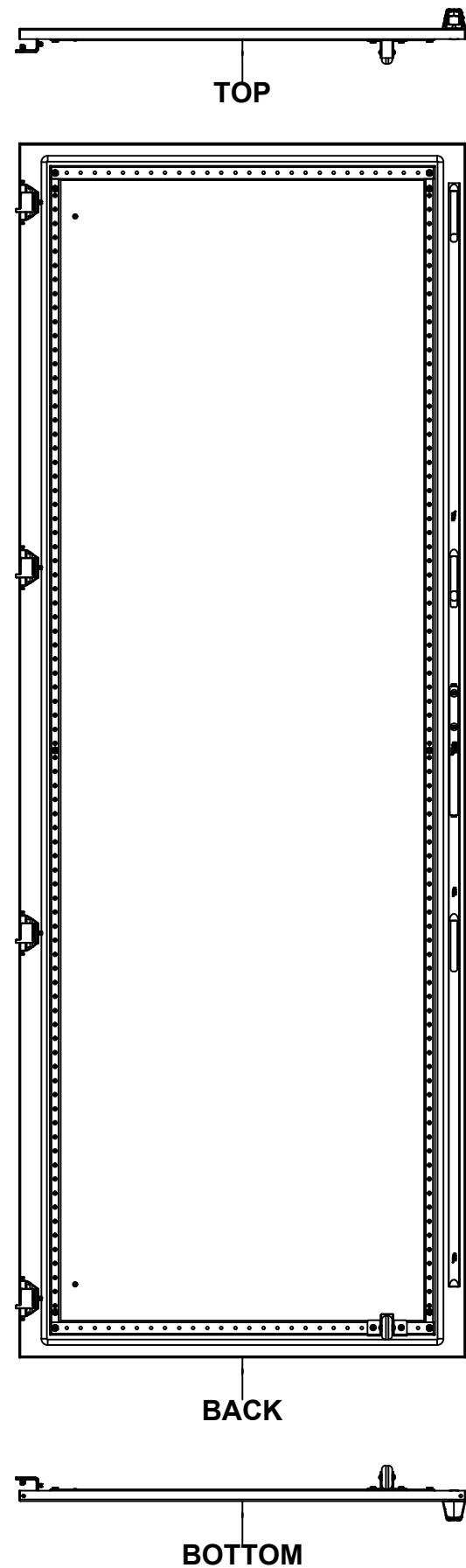

Isometric View

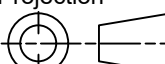

No.	Revisions	Date	By/Par

 Tél: (450) 979-4373 Fax: (450) 979-4626 www.exmweb.com		Flatness Aplatissement Max 3.0mm Projection 
Customer Client	Date	
Drawn By Dessiné Par	BoxCad: BoxCad	Date 22-Jan-15
Material Matière	14 Ga Cold Rolled A1008 CS Type B	
Color Couleur	Light Grey RAL7035	Finish Fini Textured
Description	Detail Rev.	
6500 MXD 2200mm x 800mm Front		
Part Number Numéro Pièce	Rev.	14
6500MXK220812F	0	18

Use gasket program path 6500 MX > 6500 MXD

SEE BILL OF MATERIAL ON LAST PAGE

This drawing is confidential and must not be reproduced or used without the consent of EXM

Ce dessin est confidentiel et ne doit pas être reproduit ou utilisé sans le consentement de EXM

STANDARD FEATURES ARE NOT LISTED IN THIS HOLE TABLE

HOLE TABLE - FRONT VIEW (CUSTOM FEATURE ONLY)

CUT-OUT	XDIM	YDIM	DESCRIPTION
1	100.0	130.0	GND STUD M6 x 16mm (Inside)
2	100.0	2030.0	GND STUD M6 x 16mm (Inside)
3	64.5	52.8	STIFF. STUD M6 x 18mm (Inside)
4	64.5	2107.2	STIFF. STUD M6 x 18mm (Inside)
5	730.5	52.8	STIFF. STUD M6 x 18mm (Inside)
6	730.5	2107.2	STIFF. STUD M6 x 18mm (Inside)
7	64.5	1080.0	STIFF. STUD M6 x 18mm (Inside)
8	730.5	1080.0	STIFF. STUD M6 x 18mm (Inside)
9	730.5	2079.0	STIFF. STUD M6 x 18mm (Inside)
10	730.5	81.0	STIFF. STUD M6 x 18mm (Inside)
11	64.5	2079.0	STIFF. STUD M6 x 18mm (Inside)
12	64.5	81.0	STIFF. STUD M6 x 18mm (Inside)
13	774.0	170.0	LARGE CBAR GUIDE (Inside)
14	774.0	1990.0	LARGE CBAR GUIDE (Inside)
15	774.0	805.0	LARGE CBAR GUIDE (Inside)
16	774.0	1355.0	LARGE CBAR GUIDE (Inside)

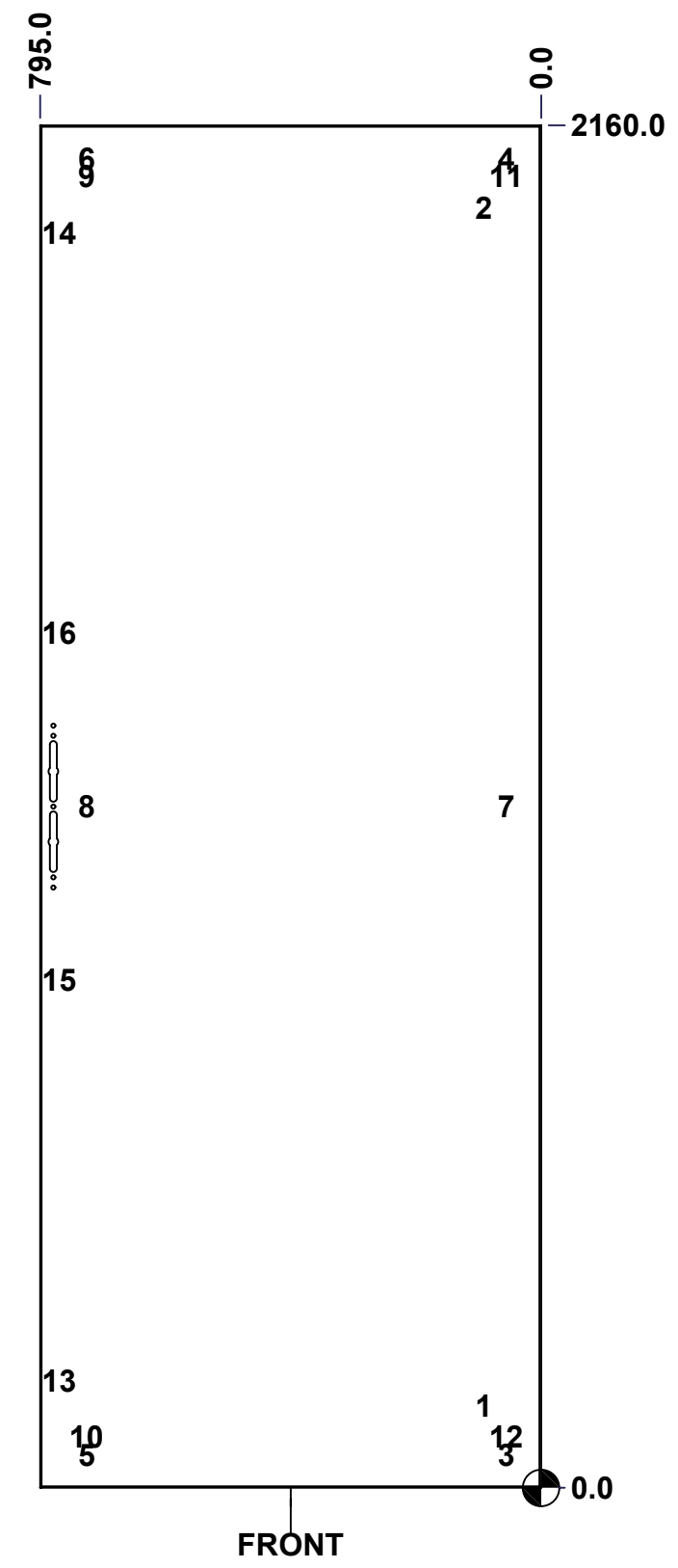

Use bending program path 6500 MX > 6500 MXD

	Description		Status
	6500 MXD 2200mm x 800mm Front		(NULL)
Part Number Numéro Pièce		Rev.	15
6500MXK220812F		0	18

This drawing is confidential and must not be reproduced or used without the consent of EXM

Ce dessin est confidentiel et ne doit pas être reproduit ou utilisé sans le consentement de EXM

No.	Revisions	Date	By/Par

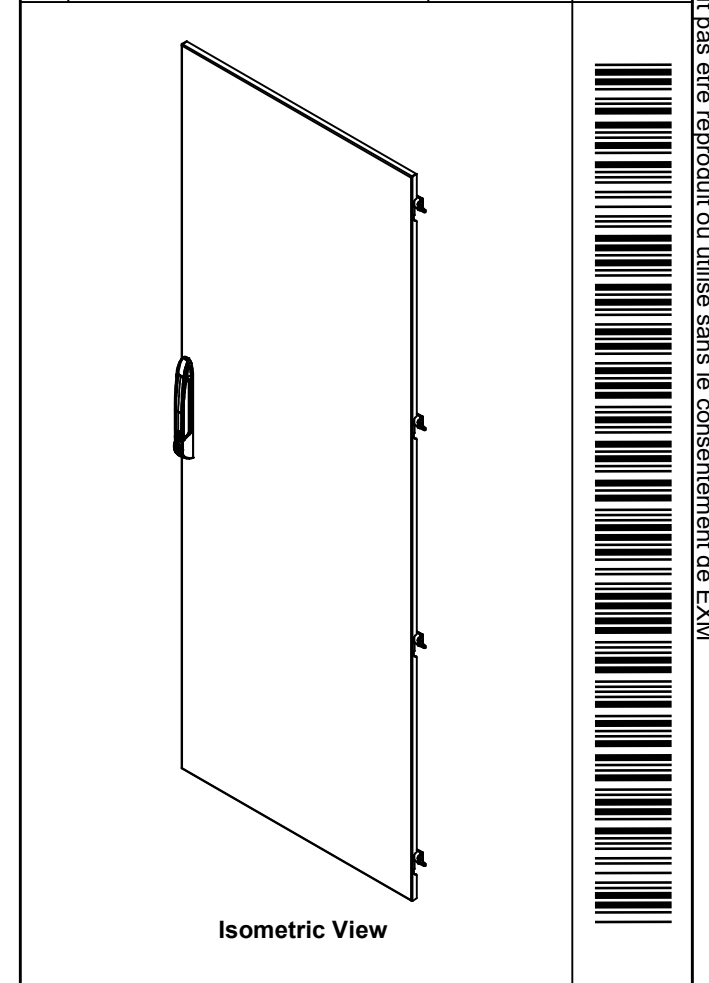

1	STK-P-03820R	0	Powder Paint (Light Grey / Rough Textured)
1	STK-A-45758	4	886 PH2 Pull Handle Bridge - Assembly
1	STK-A-51160	0	886PH2-SL - Pull Handle Lock - Assembly
1	STK-Q-45662-22	1	6500 MX - Lower Closing Bar 2200mm
1	STK-Q-45661-22	1	6500 MX - Upper Closing Bar 2200mm
1	6500MXSRK	1	6500 MXRSK Door Support Roller
4	STK-Q-16410	0	Guide Stud - Large (No Paint Cap Required)
4	STK-K-06810	7	6500 MX Hinge Assy
12	STK-Q-16055	1	M6 x 18mm Stud (No Paint Cap Required)
1	6500MXK220812DS1	5	6500 MX 2200mm x 800mm Door Stiffener
1	6500MXK220812FG	0	6500 MXD 2200mm x 800mm Front Gasket
1	6500MXK220812F-P	0	6500 MXD 2200mm x 800mm Front Part
Qty	Part Number	Rev	Description
Parts List			

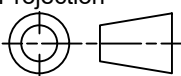
 Tél: (450) 979-4373 Fax: (450) 979-4626 www.exmweb.com		Flatness Aplatissement Max 3.0mm Projection 
Customer Client	Date	
Drawn By Dessiné Par	BoxCad: BoxCad	Date 22-Jan-15
Material Matière	14 Ga Cold Rolled A1008 CS Type B	
Color Couleur	Light Grey RAL7035	Finish Fini Textured
Description	Detail Rev.	
6500 MXD 2200mm x 800mm Front		
Part Number Numéro Pièce	Rev.	16
6500MXK220812F	0	18

This drawing is confidential and must not be reproduced or used without the consent of EXM

Ce dessin est confidentiel et ne doit pas être reproduit ou utilisé sans le consentement de EXM

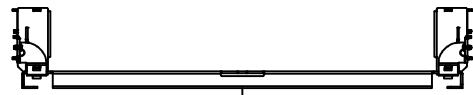

TOP

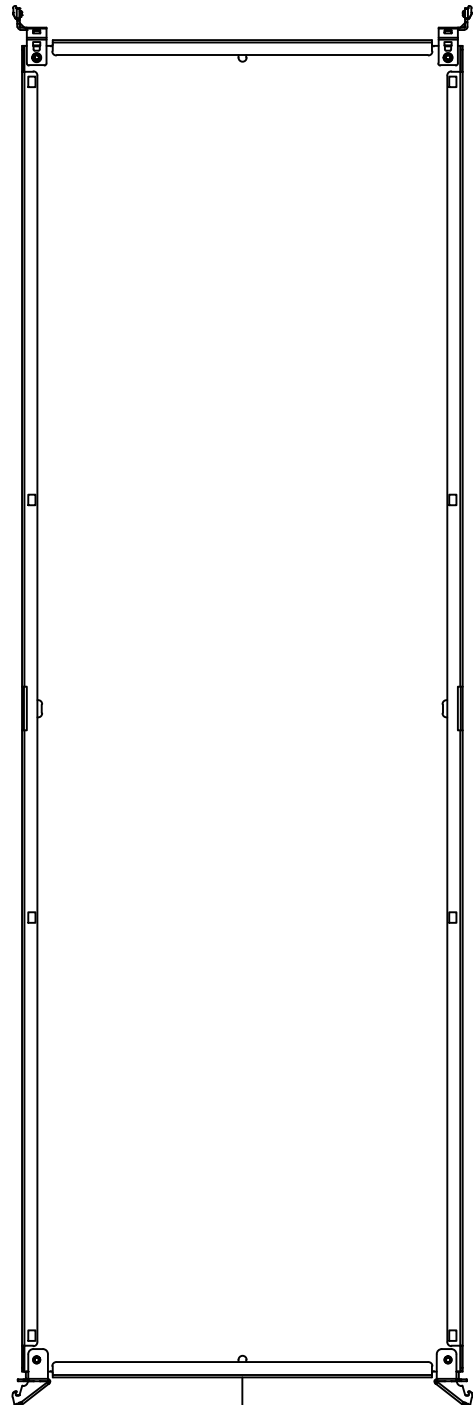

BACK



BOTTOM

0.0
26.0

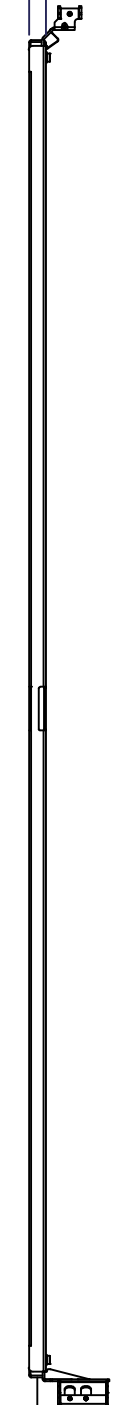

LEFT

0.0
685.0

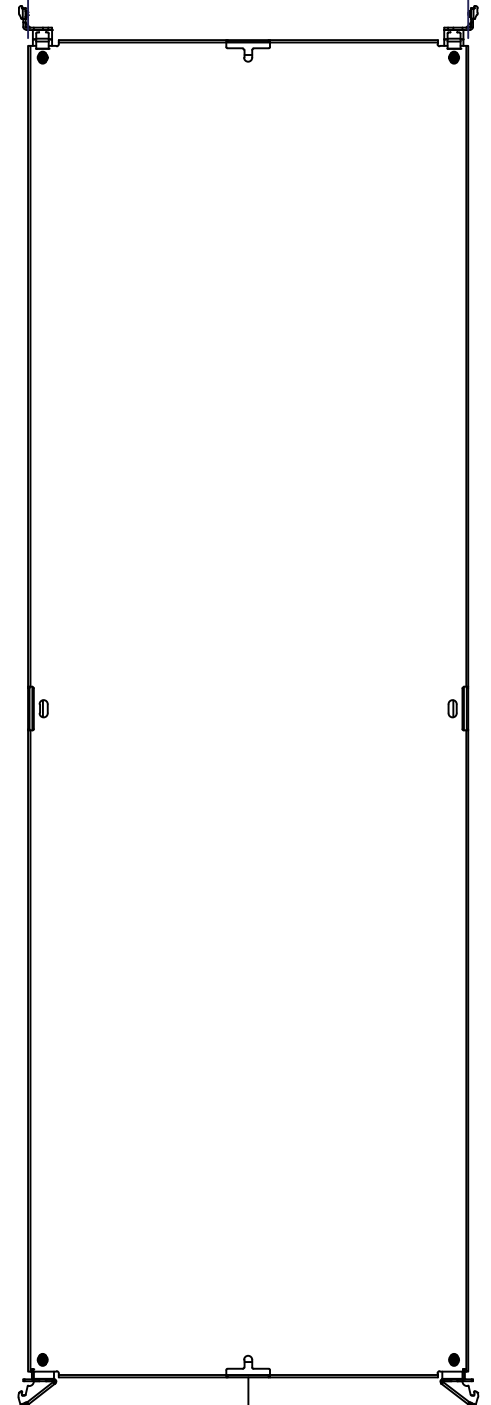

FRONT

2080.0

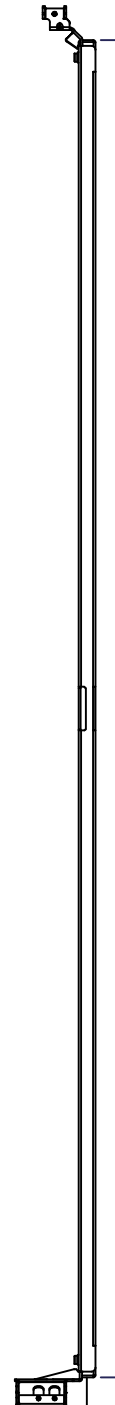

RIGHT

0.0

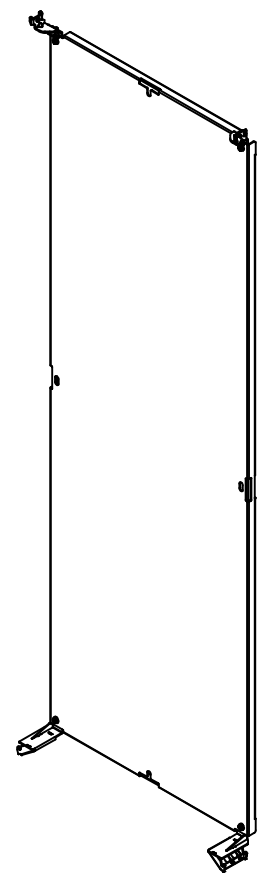

Isometric View

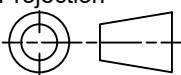

No.	Revisions	Date	By/Par

 Tél: (450) 979-4373 Fax: (450) 979-4626 www.exmweb.com		Flatness Aplatissement Max 3.0mm Projection 
Customer Client	Date	
Drawn By Dessiné Par	BoxCad: BoxCad	Date 22-Jan-15
Material Matière	12 Ga Galvanized (2.5mm)	
Color Couleur	Unpainted	Finish Fini Unpainted
Description	Detail Rev.	
6500 MXM 2200mm x 800mm Back Inner Panel		
Part Number Numéro Pièce	Rev.	17
6500MXK220812BIP	0	18

SEE BILL OF MATERIAL ON LAST PAGE

This drawing is confidential and must not be reproduced or used without the consent of EXM

Ce dessin est confidentiel et ne doit pas être reproduit ou utilisé sans le consentement de EXM

No.	Revisions	Date	By/Par

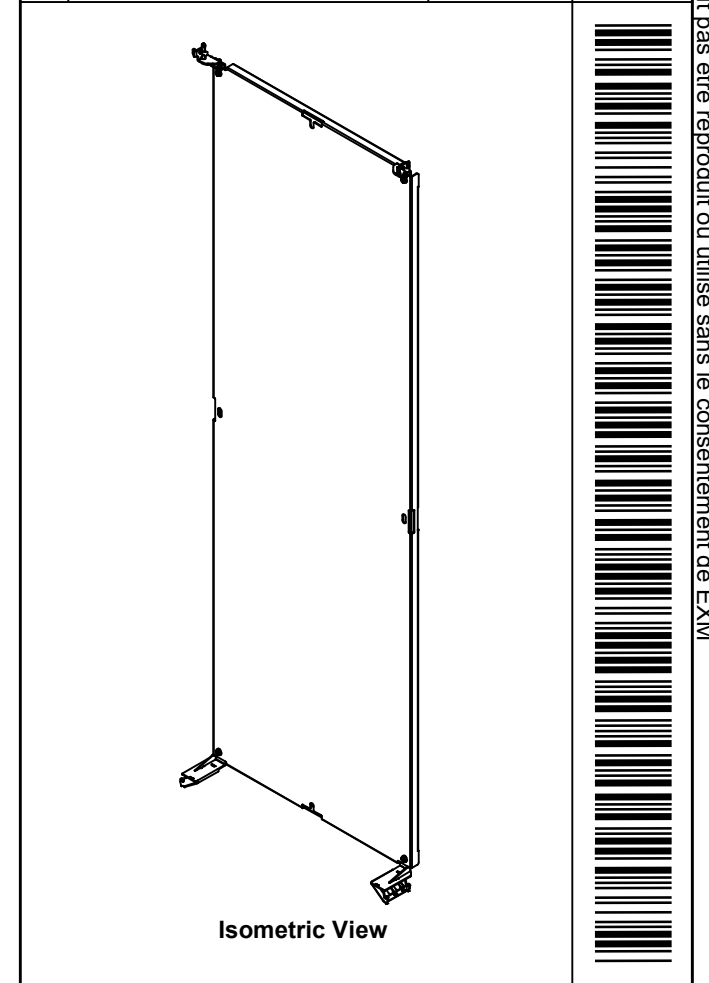

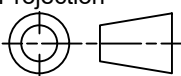
		Tél: (450) 979-4373 Fax: (450) 979-4626 www.exmweb.com		Flatness Aplatissement Max 3.0mm	
Customer Client		Date		Projection 	
Drawn By / Dessiné Par: BoxCad: BoxCad		Date: 22-Jan-15		Material / Matière: 12 Ga Galvanized (2.5mm)	
Color / Couleur: Unpainted		Finish / Fini: Unpainted		Description: 6500 MXM 2200mm x 800mm Back Inner Panel	
Part Number / Numéro Pièce: 6500MXK220812BIP		Rev. 0		Detail Rev. 18	

Qty	Part Number	Rev	Description
1	STK-A-49005	5	6500 MXM - Bottom Inner Panel Support Assembly (Right)
1	STK-A-49000	5	6500 MXM - Bottom Inner Panel Support Assembly (Left)
1	STK-A-49015	0	6500MXM - Top Inner Panel Support Kit (Right)
1	STK-A-49010	0	6500MXM - Top Inner Panel Support Kit (Left)
1	6500MXK220812BIP-P	0	6500 MXM 2200mm x 800mm Back Inner Panel Part
Parts List			