

This drawing is confidential and must not be reproduced or used without the consent of EXM

Ce dessin est confidentiel et ne doit pas être reproduit ou utilisé sans le consentement de EXM

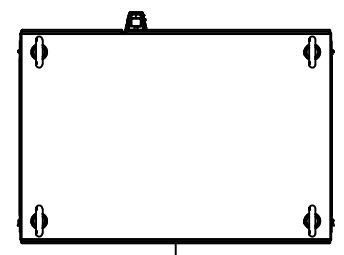

TOP

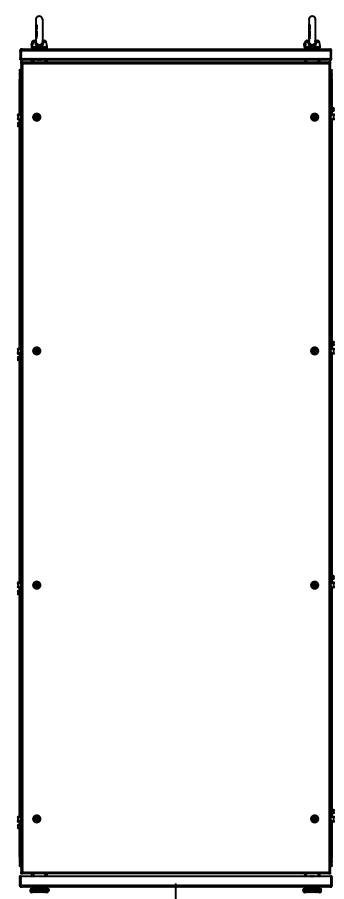

BACK

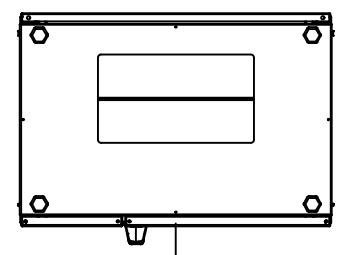

BOTTOM

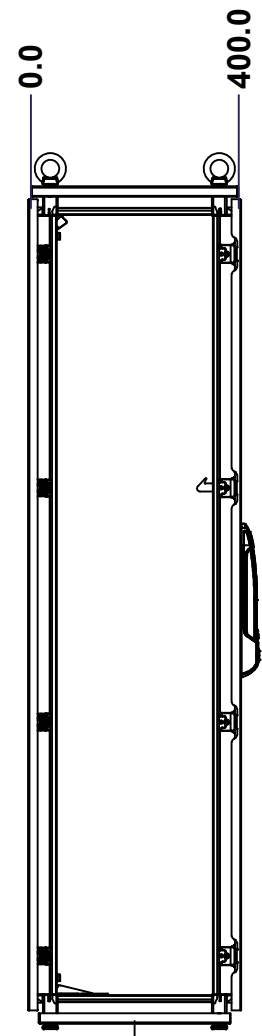

LEFT

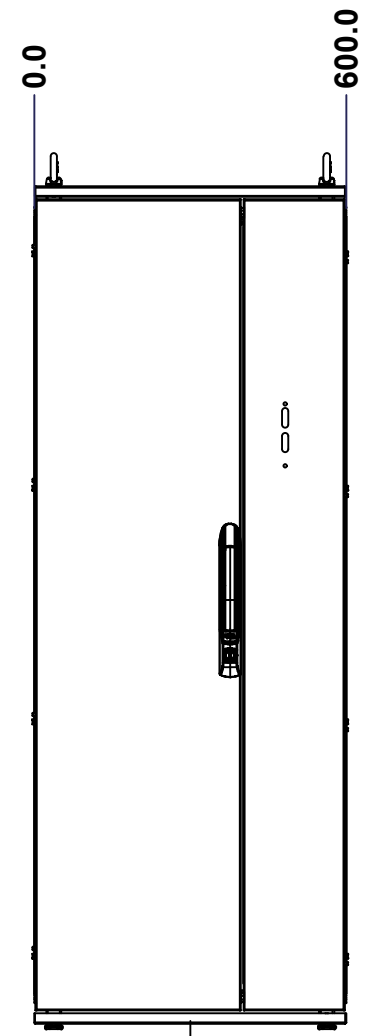

FRONT

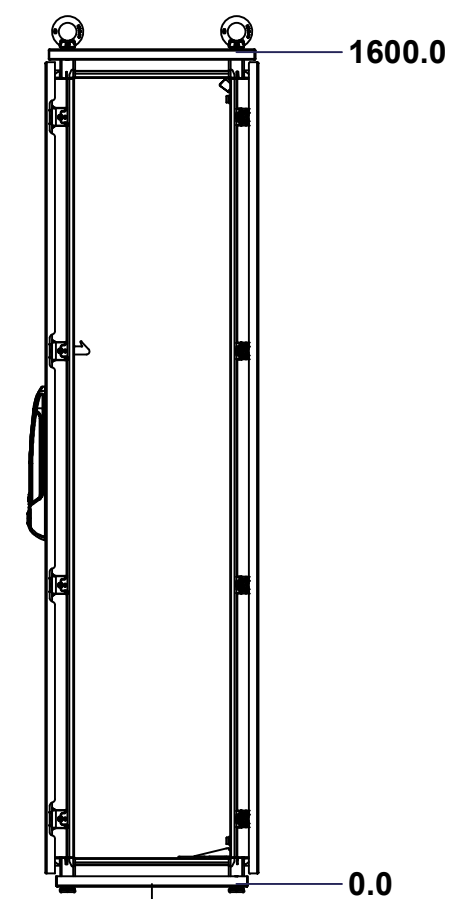

RIGHT

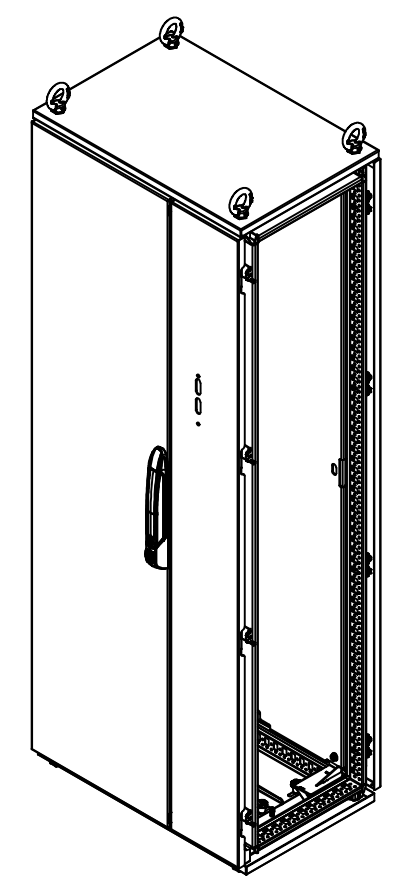

Isometric View



No.	Revisions	Date	By/Par



Tél: (450) 979-4373  
 Fax: (450) 979-4626  
[www.exmweb.com](http://www.exmweb.com)

Flatness  
Aplatissement  
Max 3.0mm  
Projection

Customer Client  
 Drawn By Dessiné Par BoxCad: BoxCad  
 Date 04-Mar-15

Material Matière See Part List

Color Couleur See Part List  
 Finish Fini See Part List

Description 6500MX 1600mm x 600mm x 400mm Assembly  
 Detail Rev.

Part Number Numéro Pièce **6500MXU160604**  
 Rev. **0** 1/18

SEE BILL OF MATERIAL ON LAST PAGE

This drawing is confidential and must not be reproduced or used without the consent of EXM

Ce dessin est confidentiel et ne doit pas être reproduit ou utilisé sans le consentement de EXM

No.	Revisions	Date	By/Par



Isometric View



Tél: (450) 979-4373  
 Fax: (450) 979-4626  
[www.exmweb.com](http://www.exmweb.com)

Flatness  
Aplatissement  
Max 3.0mm  
Projection

Customer Client	Date
Drawn By / Dessiné Par: BoxCad: BoxCad	Date: 04-Mar-15
Material / Matière	See Part List

1	6500MXU160604BIP	0	6500 MXM 1600mm x 600mm Back Inner Panel
1	6500MXU160604F	0	6500 MXDU 1600mm x 600mm Front
1	6500MXU160604B	0	6500 MXR 1600mm x 600mm Back
1	6500MXU160604BT	0	6500 MXB 600mm x 400mm Bottom
1	6500MXU160604T	0	6500 MXT 600mm x 400mm Top
1	6500MXU160604FR	0	6500 MX 1600mm x 600mm x 400mm Frame

Color / Couleur	See Part List	Finish / Fini	See Part List
Description	6500MX 1600mm x 600mm x 400mm Assembly		Detail Rev.

Qty	Part Number	Rev	Description
Parts List			

Part Number / Numéro Pièce	Rev.	2
<b>6500MXU160604</b>	<b>0</b>	18

This drawing is confidential and must not be reproduced or used without the consent of EXM

Ce dessin est confidentiel et ne doit pas être reproduit ou utilisé sans le consentement de EXM

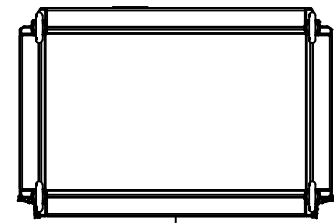

TOP

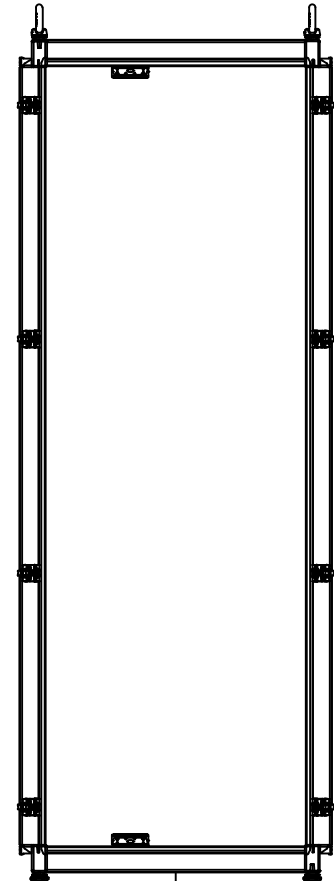

BACK

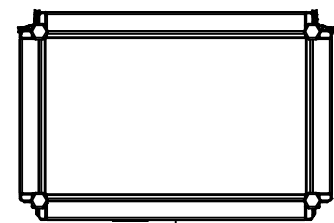

BOTTOM

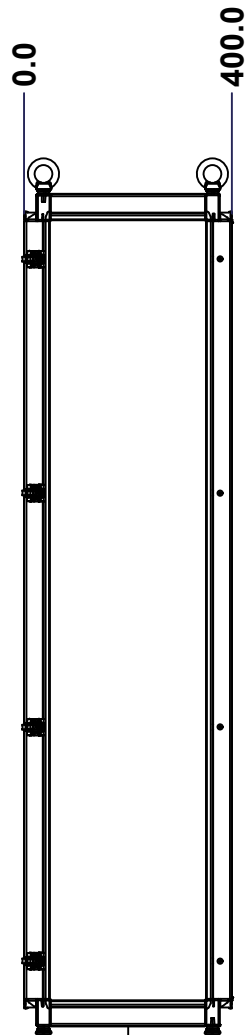

LEFT

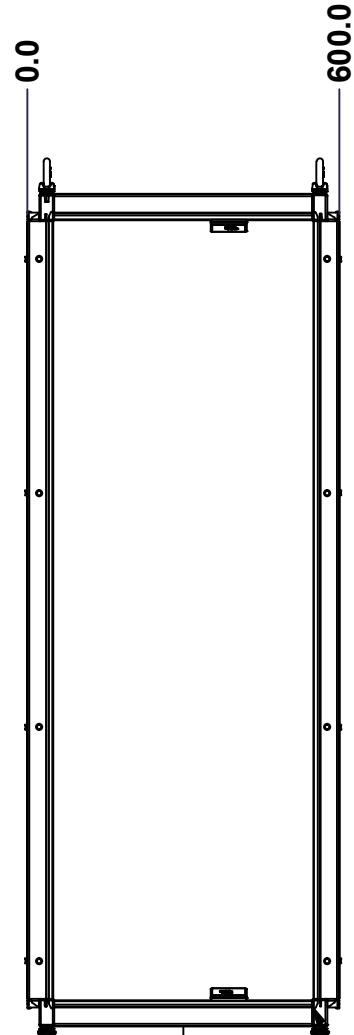

FRONT

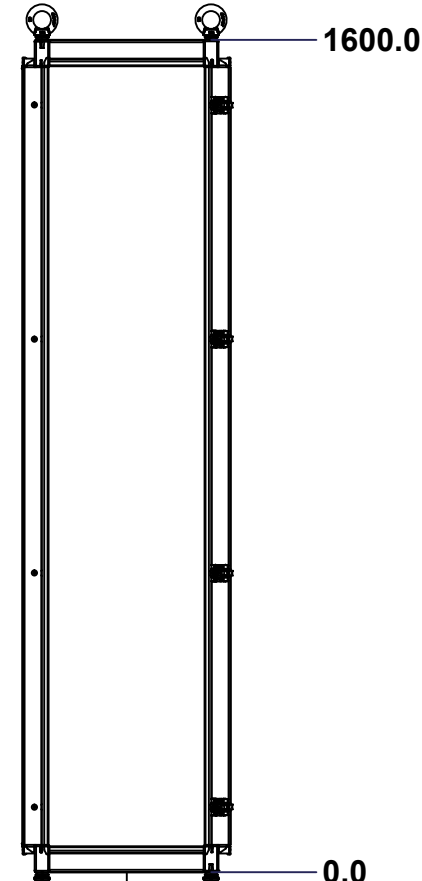

RIGHT

Grind excess weld off corner(s)

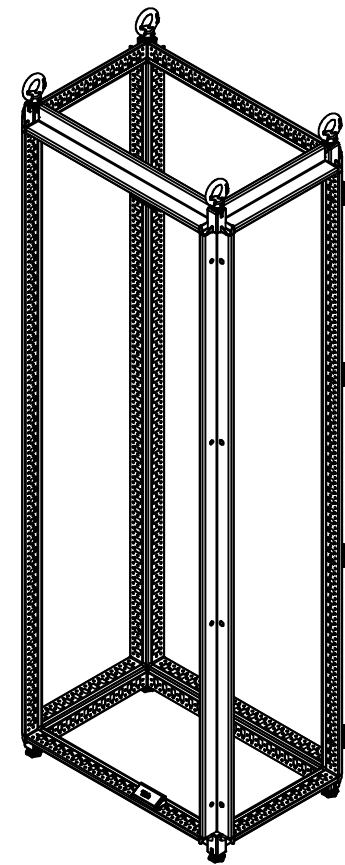

Isometric View

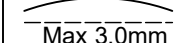
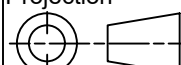

No.	Revisions	Date	By/Par

 Tél: (450) 979-4373 Fax: (450) 979-4626 <a href="http://www.exmweb.com">www.exmweb.com</a>		Flatness Aplatissement  Max 3.0mm Projection 
Customer Client		Date
Drawn By Dessiné Par	BoxCad: BoxCad	Date 04-Mar-15
Material Matière	16 Ga Electro-Galvanized (1.4mm)	
Color Couleur	Iron Grey RAL7011	Finish Fini Textured
Description	Detail Rev.	
6500 MX 1600mm x 600mm x 400mm Frame		
Part Number Numéro Pièce	Rev.	3
<b>6500MXU160604FR</b>	<b>0</b>	18

SEE BILL OF MATERIAL ON LAST PAGE

This drawing is confidential and must not be reproduced or used without the consent of EXM

Ce dessin est confidentiel et ne doit pas être reproduit ou utilisé sans le consentement de EXM

No.	Revisions	Date	By/Par

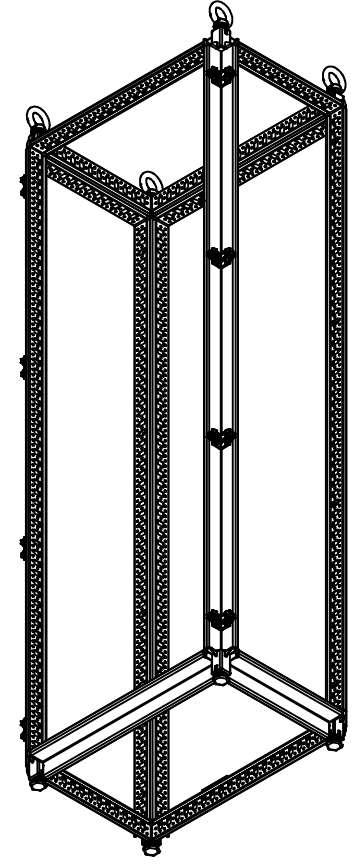

Isometric View

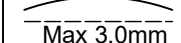
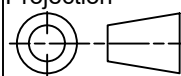

Qty	Part Number	Rev	Description
1	STK-P-03810ST	0	Powder Paint (Iron Grey /Sand Textured)
4	STK-Q-47250-06	6	6500 MX 600mm Horizontal Frame Post Part
4	STK-Q-47250-04	6	6500 MX 400mm Horizontal Frame Post Part
2	STK-Q-05020	5	M5 x 8mm Thread Rolling Screw
2	STK-A-74730	2	6500 MX - Flange Door Sealing Block
16	STK-Q-77120	1	6500MX-Frame Rubber Plug
8	STK-A-70580	9	Mtrx Bracket
8	STK-Q-00610	3	M16 x 30.0mm Bolt
8	STK-A-49448	6	6500 MX - Frame Sheet Metal Corner Assembly
4	STK-Q-49500	3	M12 Eye Bolt (0.34T)
4	STK-Q-61110	0	M12 Feet Leveler
4	STK-Q-47251-16	6	6500 MX 1600mm Vertical Frame Post Part

 Tél: (450) 979-4373 Fax: (450) 979-4626 <a href="http://www.exmweb.com">www.exmweb.com</a>		Flatness Aplatissement  Max 3.0mm Projection 
Customer Client	Date	Date 04-Mar-15
Drawn By Dessiné Par	BoxCad: BoxCad	
Material Matière	16 Ga Electro-Galvanized (1.4mm)	
Color Couleur	Iron Grey RAL7011	Finish Fini Textured
Description	Detail Rev.	
6500 MX 1600mm x 600mm x 400mm Frame		
Part Number Numéro Pièce	Rev.	4
<b>6500MXU160604FR</b>	<b>0</b>	18

This drawing is confidential and must not be reproduced or used without the consent of EXM

Ce dessin est confidentiel et ne doit pas être reproduit ou utilisé sans le consentement de EXM

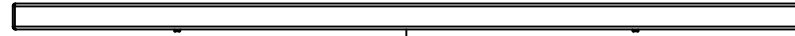

TOP

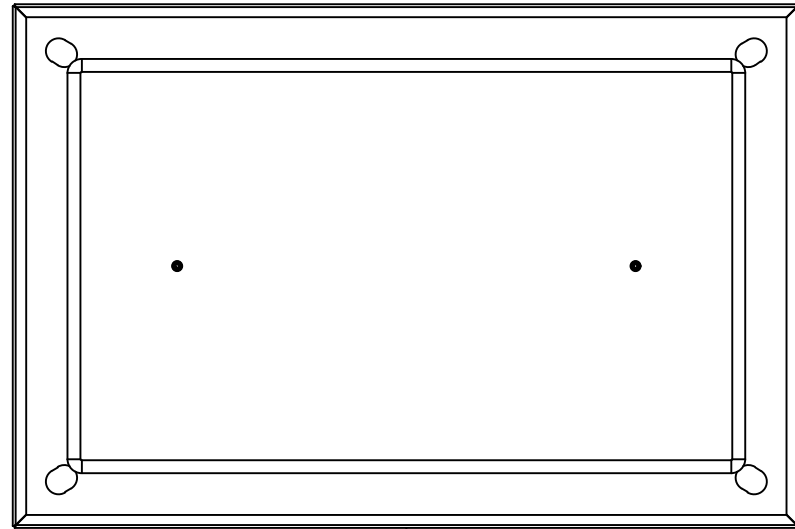

BACK

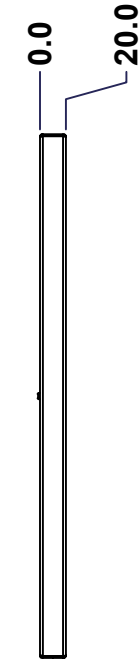

LEFT

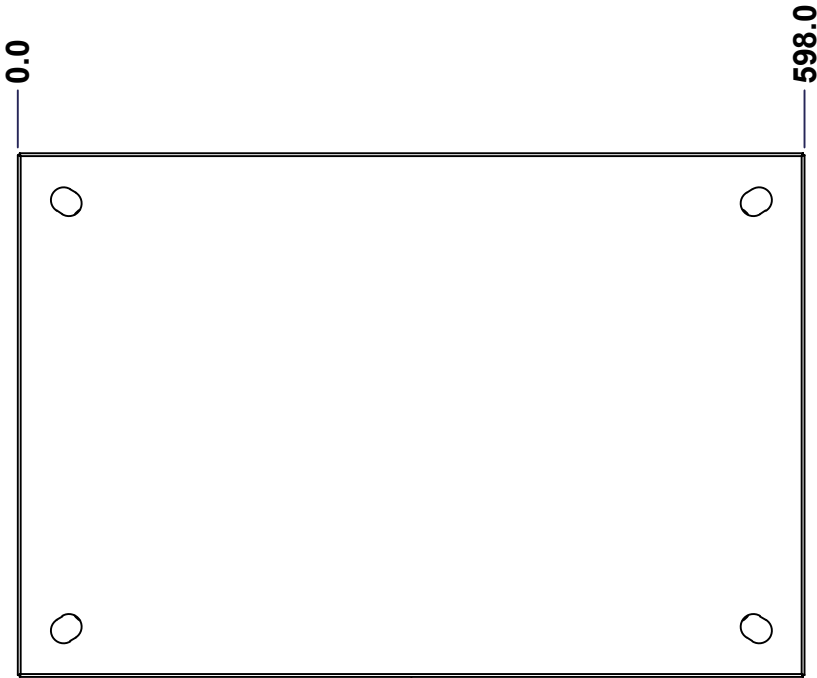

FRONT

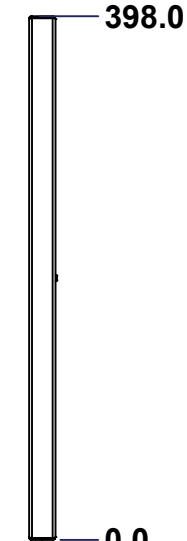

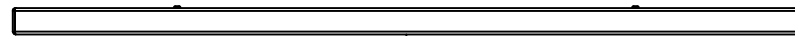

RIGHT

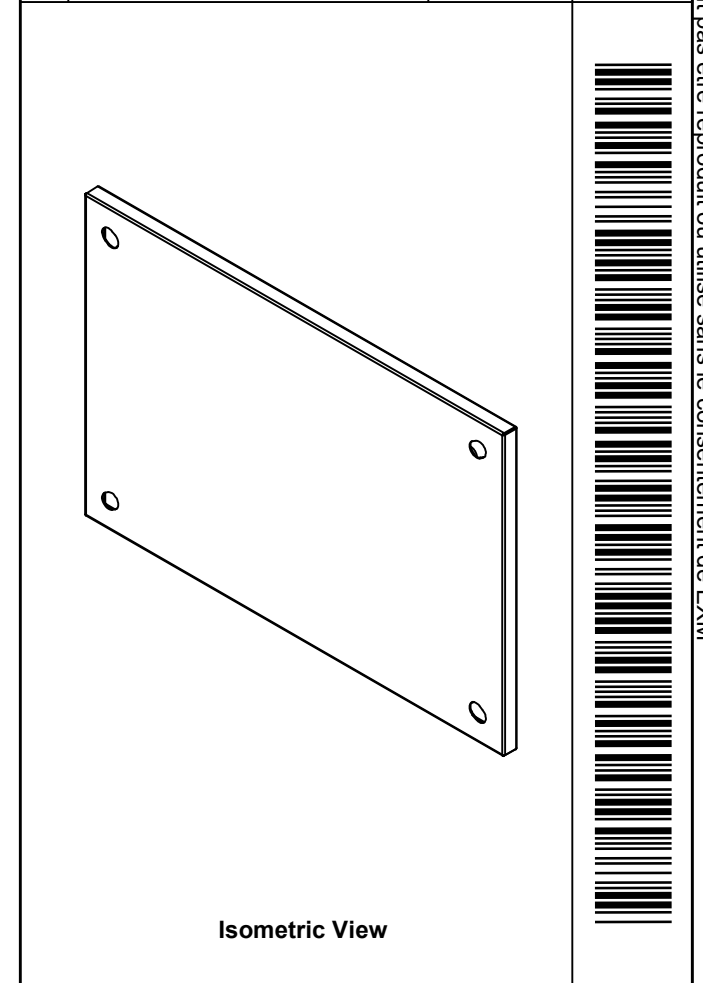

BOTTOM

No.	Revisions	Date	By/Par

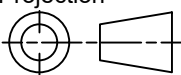

 Tél: (450) 979-4373 Fax: (450) 979-4626 <a href="http://www.exmweb.com">www.exmweb.com</a>		Flatness Aplatissement Max 3.0mm Projection 
Customer Client	Date	
Drawn By Dessiné Par	BoxCad: BoxCad	Date 04-Mar-15
Material Matière	16 Ga Cold Rolled A1008 CS Type B	
Color Couleur	Iron Grey RAL7011	Finish Fini Textured
Description	Detail Rev.	
6500 MXT 600mm x 400mm Top		
Part Number Numéro Pièce	Rev.	5
<b>6500MXU160604T</b>	<b>0</b>	18

Use gasket program path 6500 MX > 6500 MXT

SEE BILL OF MATERIAL ON LAST PAGE

This drawing is confidential and must not be reproduced or used without the consent of EXM

Ce dessin est confidentiel et ne doit pas être reproduit ou utilisé sans le consentement de EXM

STANDARD FEATURES ARE NOT LISTED IN THIS HOLE TABLE			
HOLE TABLE - FRONT VIEW (CUSTOM FEATURE ONLY)			
CUT-OUT	XDIM	YDIM	DESCRIPTION
1	125.0	199.0	GND STUD M6 x 18mm (Inside)
2	473.0	199.0	GND STUD M6 x 18mm (Inside)



FRONT

Use bending program path 6500 MX > 6500 MXT

	Description		Status
	6500 MXT 600mm x 400mm Top		(NULL)
Part Number Numéro Pièce		Rev.	6
<b>6500MXU160604T</b>		<b>0</b>	18

This drawing is confidential and must not be reproduced or used without the consent of EXM

Ce dessin est confidentiel et ne doit pas être reproduit ou utilisé sans le consentement de EXM

No.	Revisions	Date	By/Par

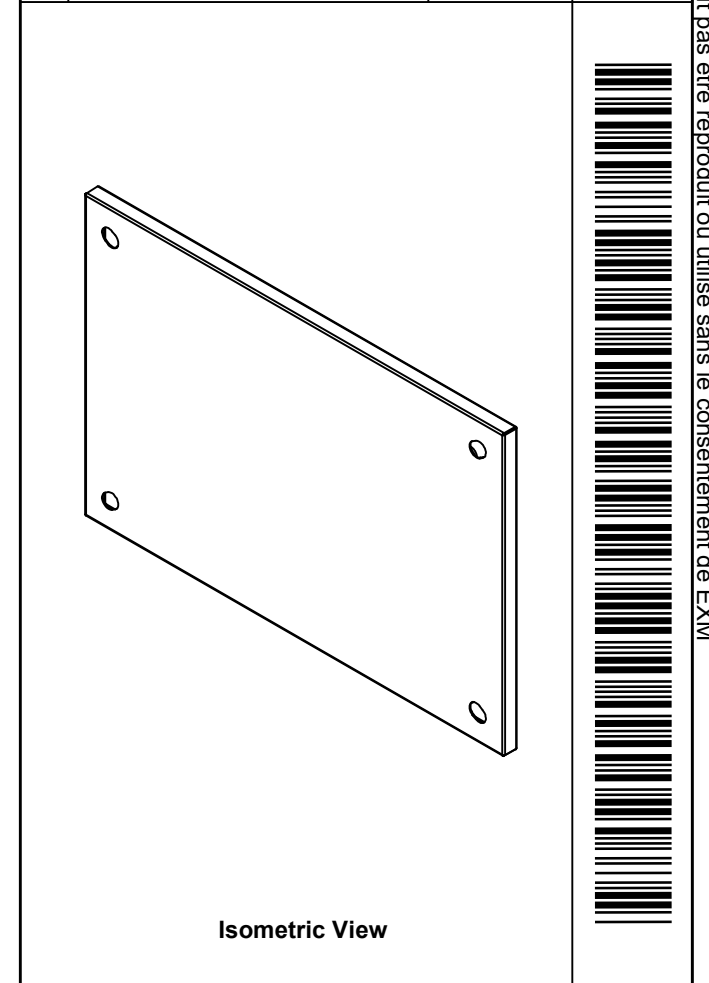

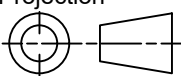
 Tél: (450) 979-4373 Fax: (450) 979-4626 <a href="http://www.exmweb.com">www.exmweb.com</a>		Flatness Aplatissement Max 3.0mm Projection 
Customer Client	Date	
Drawn By Dessiné Par	BoxCad: BoxCad	Date 04-Mar-15
Material Matière	16 Ga Cold Rolled A1008 CS Type B	
Color Couleur	Iron Grey RAL7011	Finish Fini Textured
Description		Detail Rev.
6500 MXT 600mm x 400mm Top		
Part Number Numéro Pièce	Rev.	7
<b>6500MXU160604T</b>	<b>0</b>	18

Qty	Part Number	Rev	Description
1	STK-P-03810ST	0	Powder Paint (Iron Grey /Sand Textured)
2	STK-Q-16055	1	M6 x 18mm Stud (No Paint Cap Required)
1	6500MXU160604TG	0	6500 MXT 600mm x 400mm Top Gasket
1	6500MXU160604T-P	0	6500 MXT 600mm x 400mm Top Part
Parts List			

This drawing is confidential and must not be reproduced or used without the consent of EXM

Ce dessin est confidentiel et ne doit pas être reproduit ou utilisé sans le consentement de EXM

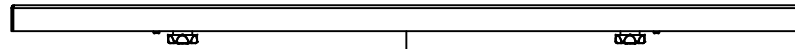

TOP

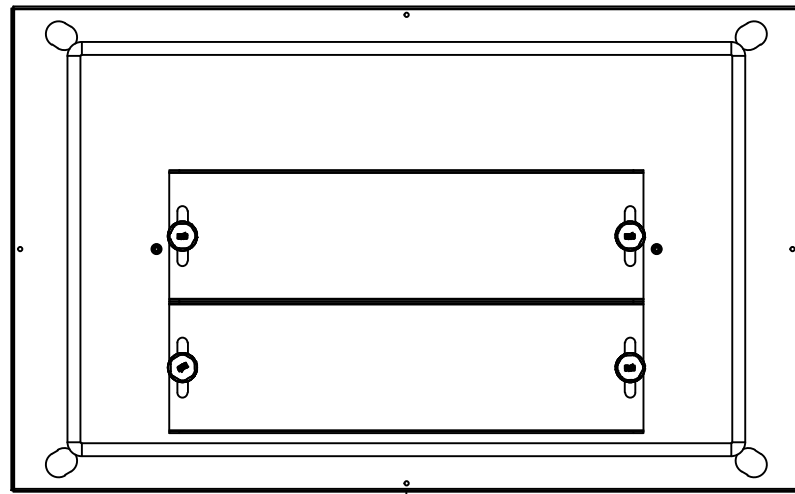

BACK

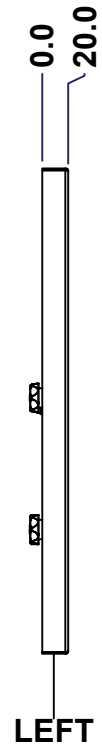

LEFT

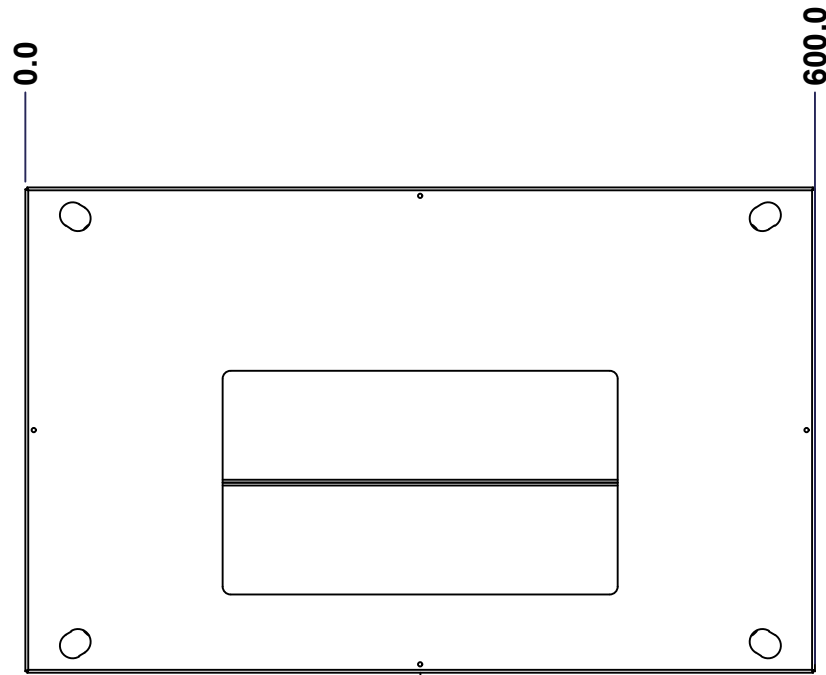

FRONT

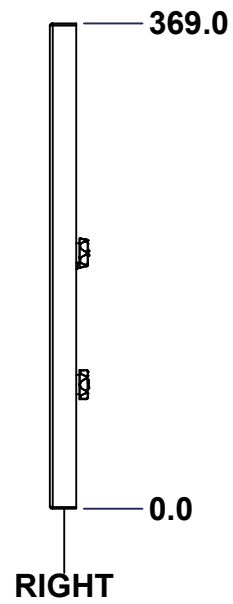

RIGHT

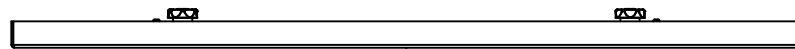

BOTTOM

No.	Revisions	Date	By/Par

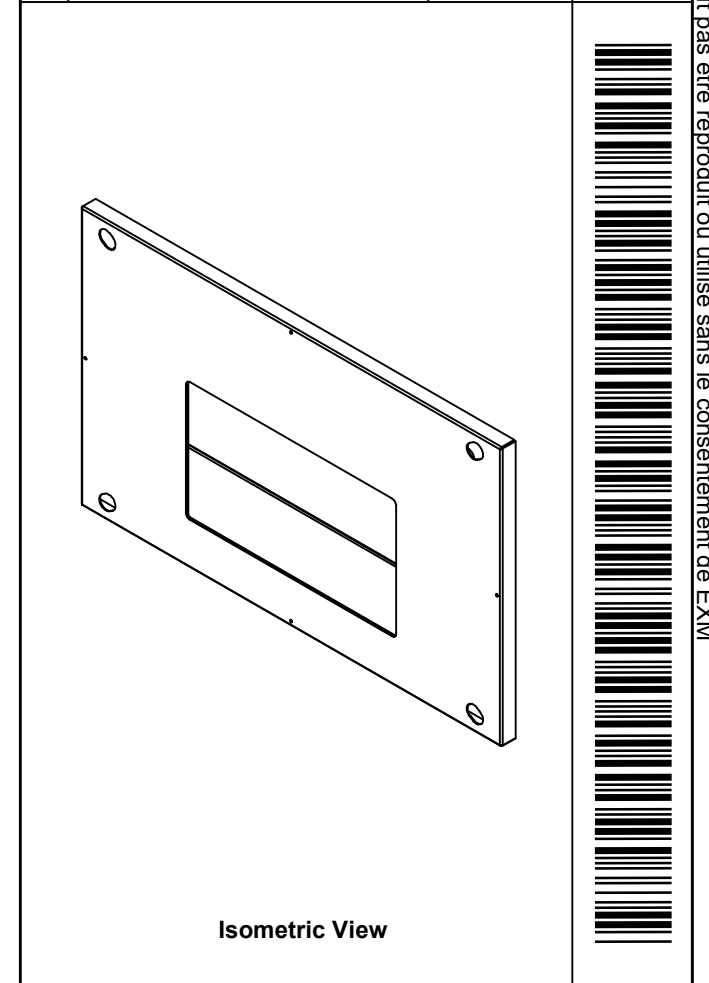

Isometric View

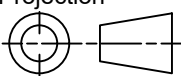
 Tél: (450) 979-4373 Fax: (450) 979-4626 <a href="http://www.exmweb.com">www.exmweb.com</a>		Flatness Aplatissement Max 3.0mm Projection 
Customer Client	Date	
Drawn By Dessiné Par	BoxCad: BoxCad	Date 04-Mar-15
Material Matière	16 Ga Cold Rolled A1008 CS Type B	
Color Couleur	Iron Grey RAL7011	Finish Fini Textured
Description	Detail Rev.	
6500 MXB 600mm x 400mm Bottom		
Part Number Numéro Pièce	Rev.	8
<b>6500MXU160604BT</b>	<b>0</b>	18

Use gasket program path 6500 MX > 6500MXB

SEE BILL OF MATERIAL ON LAST PAGE

This drawing is confidential and must not be reproduced or used without the consent of EXM

Ce dessin est confidentiel et ne doit pas être reproduit ou utilisé sans le consentement de EXM

**STANDARD FEATURES ARE NOT LISTED IN THIS HOLE TABLE**

**HOLE TABLE - FRONT VIEW (CUSTOM FEATURE ONLY)**

CUT-OUT	XDIM	YDIM	DESCRIPTION
1	110.0	184.5	GND STUD M6 x 18mm (Inside)
2	490.0	184.5	GND STUD M6 x 18mm (Inside)
3	130.0	194.5	GP STUD M6 x 18mm (Inside)
4	470.0	194.5	GP STUD M6 x 18mm (Inside)
5	130.0	94.5	GP STUD M6 x 18mm (Inside)
6	470.0	94.5	GP STUD M6 x 18mm (Inside)

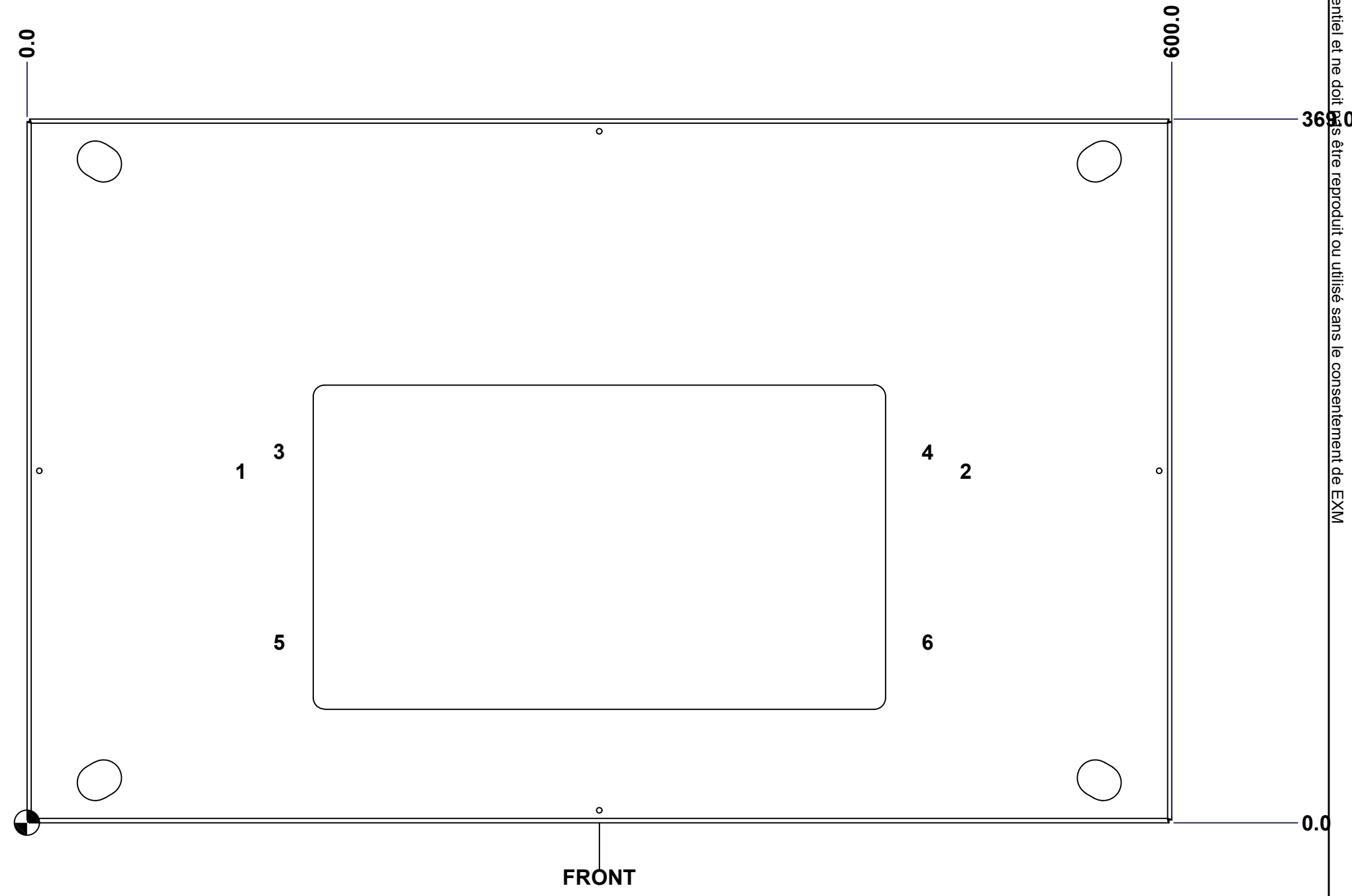

Use bending program path 6500 MX > 6500MXB

	Description 6500 MXB 600mm x 400mm Bottom	Status (NULL)
	Part Number Numéro Pièce <b>6500MXU160604BT</b>	Rev. 9 <b>0</b>

This drawing is confidential and must not be reproduced or used without the consent of EXM

Ce dessin est confidentiel et ne doit pas être reproduit ou utilisé sans le consentement de EXM

No.	Revisions	Date	By/Par

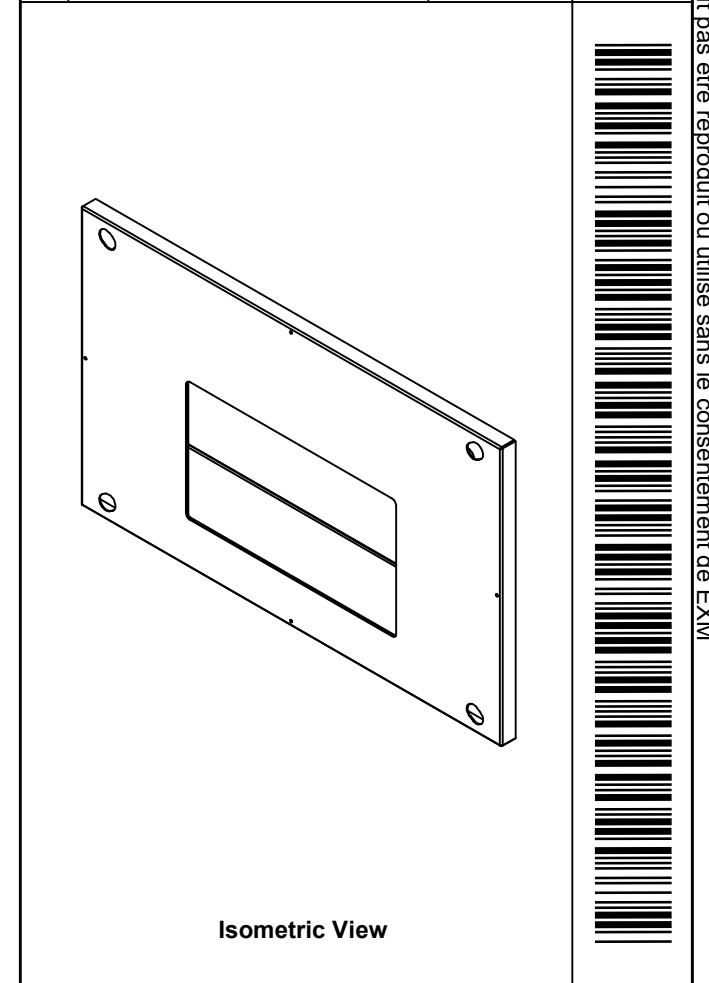

**EXM**  
www.exmweb.com

Tél: (450) 979-4373  
Fax: (450) 979-4626

Flatness  
Aplatissement  
Max 3.0mm

Projection

Customer Client \_\_\_\_\_ Date \_\_\_\_\_  
 Drawn By Dessiné Par BoxCad: BoxCad Date 04-Mar-15

Material Matière 16 Ga Cold Rolled A1008 CS Type B

Color Couleur Iron Grey RAL7011 Finish Fini Textured

Description 6500 MXB 600mm x 400mm Bottom  
 Detail Rev. \_\_\_\_\_

Part Number Numéro Pièce **6500MXU160604BT** Rev. **0** 10/18

Qty	Part Number	Rev	Description
1	STK-P-03810ST	0	Powder Paint (Iron Grey /Sand Textured)
4	STK-Q-06001	0	Mtrx - Gland Plate M6 Plastic Thumb Nut
6	STK-Q-16055	1	M6 x 18mm Stud (No Paint Cap Required)
2	6500MXU160604GP100-P	0	6500 MXB 600mm Gland Plate Part (100mm)
1	6500MXU160604BTGPG	0	6500 MXB 600mm x 400mm Bottom Gland Plate Gasket
1	6500MXU160604BTG	0	6500 MXB 600mm x 400mm Bottom Gasket
1	6500MXU160604BT-P	0	6500 MXB 600mm x 400mm Bottom Part
Parts List			

This drawing is confidential and must not be reproduced or used without the consent of EXM

Ce dessin est confidentiel et ne doit pas être reproduit ou utilisé sans le consentement de EXM

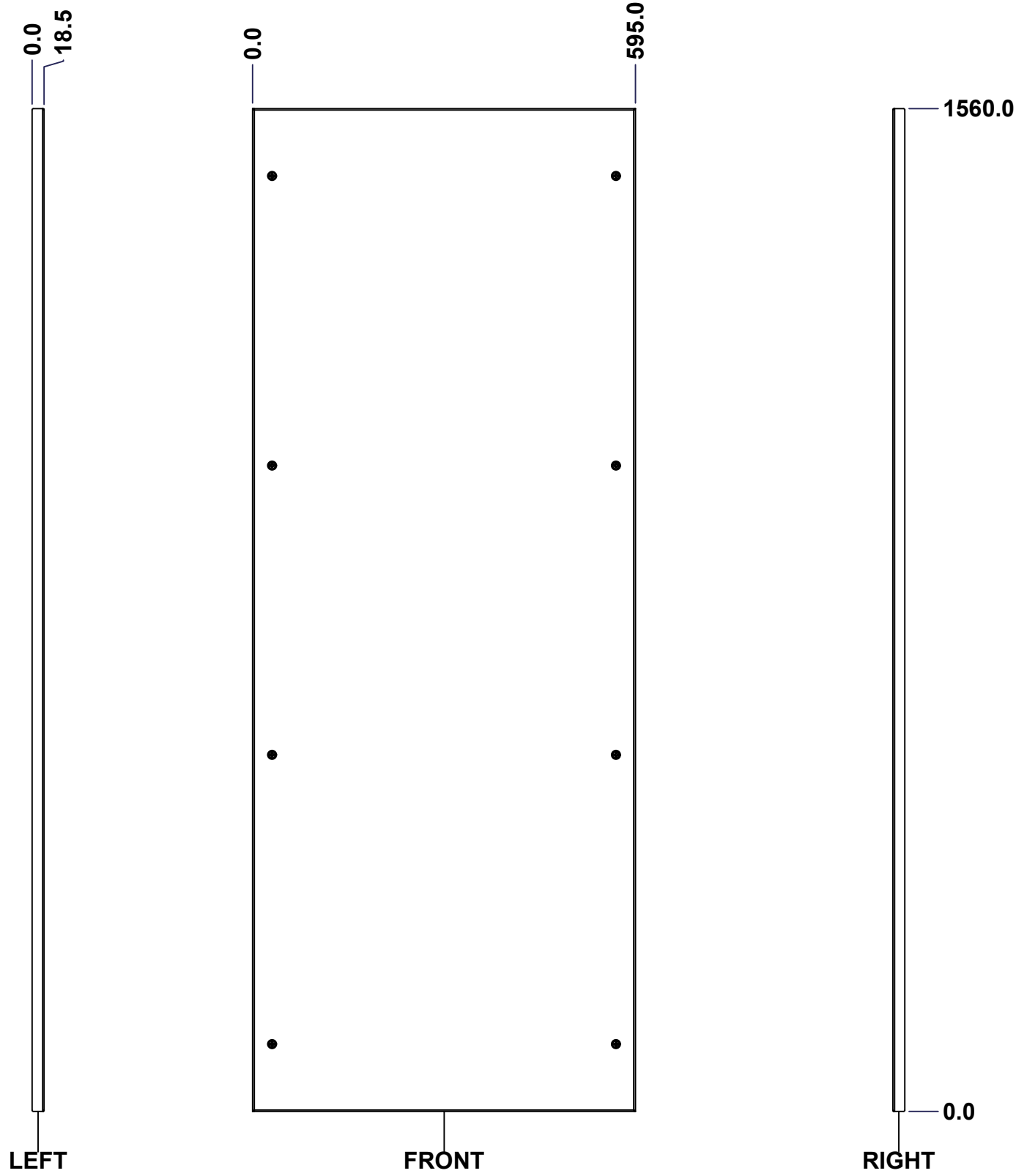
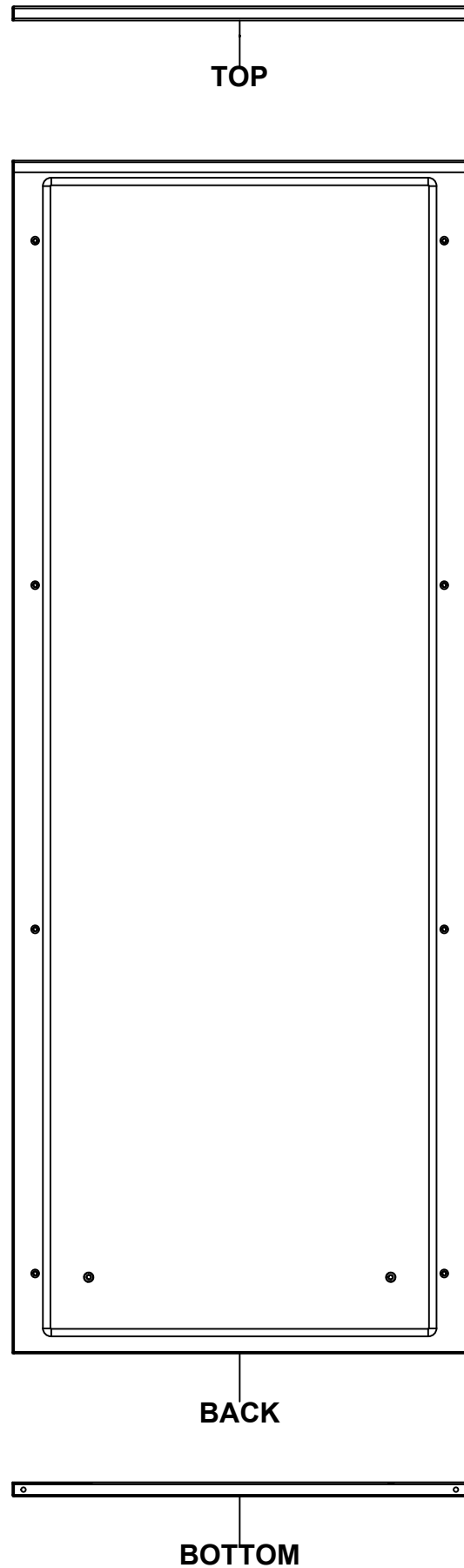

No.	Revisions	Date	By/Par

**Isometric View**

<p>Tél: (450) 979-4373 Fax: (450) 979-4626 <a href="http://www.exmweb.com">www.exmweb.com</a></p>		Flatness Aplatissement
		Max 3.0mm
		Projection
Customer Client		Date
Drawn By Dessiné Par	BoxCad: BoxCad	Date 04-Mar-15
Material Matière	14 Ga Cold Rolled A1008 CS Type B	
Color Couleur	Light Grey RAL7035	Finish Fini Textured
Description		Detail Rev.
6500 MXR 1600mm x 600mm Back		
Part Number Numéro Pièce	Rev.	11
<b>6500MXU160604B</b>	<b>0</b>	18

Use gasket program path 6500 MX > 6500 MXR

SEE BILL OF MATERIAL ON LAST PAGE

This drawing is confidential and must not be reproduced or used without the consent of EXM

Ce dessin est confidentiel et ne doit pas être reproduit ou utilisé sans le consentement de EXM

STANDARD FEATURES ARE NOT LISTED IN THIS HOLE TABLE			
HOLE TABLE - FRONT VIEW (CUSTOM FEATURE ONLY)			
CUT-OUT	XDIM	YDIM	DESCRIPTION
1	100.0	100.0	GND STUD M6 x 16mm (Inside)
2	495.0	100.0	GND STUD M6 x 16mm (Inside)

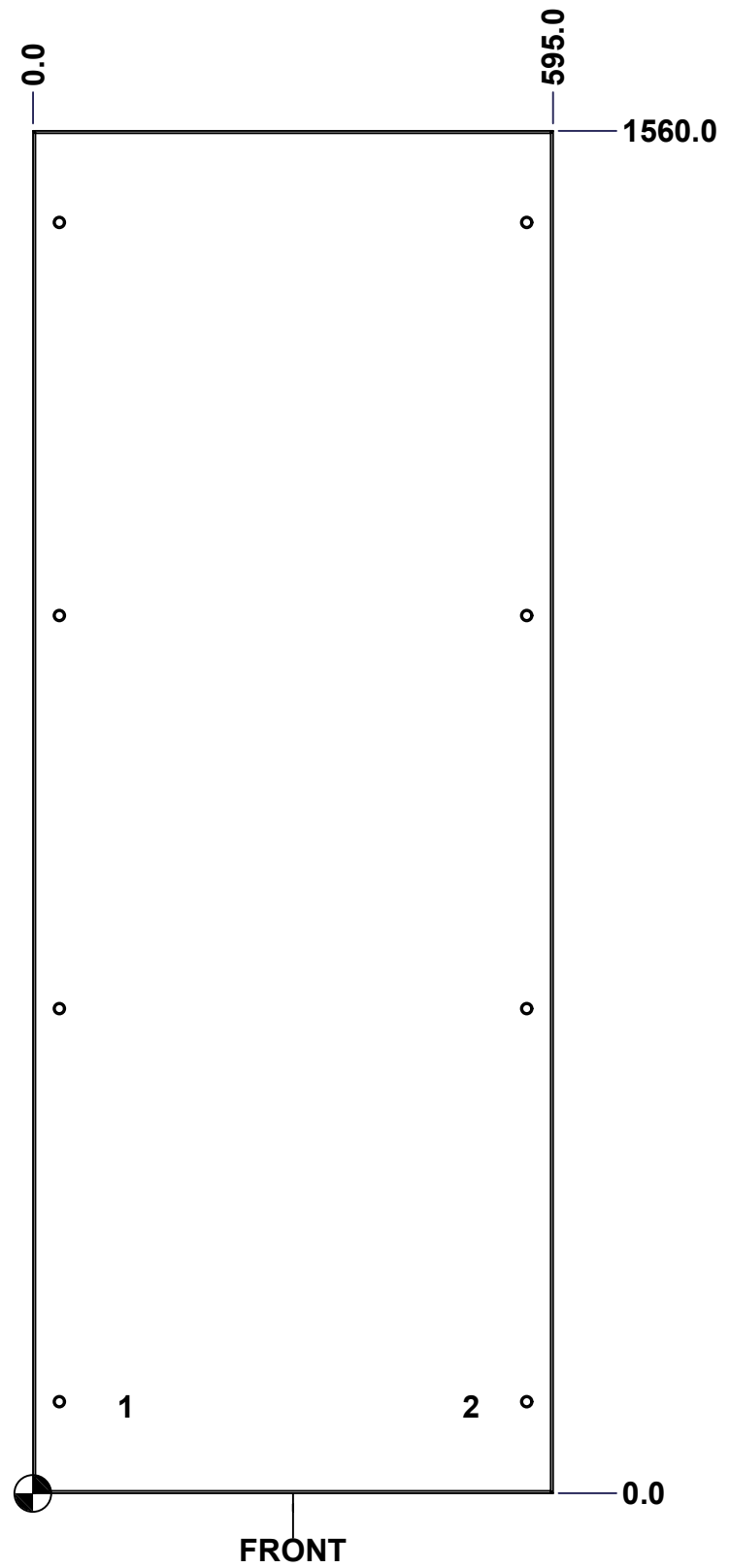

Use bending program path 6500 MX > 6500 MXR

	Description	Status
	6500 MXR 1600mm x 600mm Back	(NULL)
	Part Number Numéro Pièce	Rev.
	<b>6500MXU160604B</b>	<b>0</b>
		12
		18

This drawing is confidential and must not be reproduced or used without the consent of EXM

Ce dessin est confidentiel et ne doit pas être reproduit ou utilisé sans le consentement de EXM

No.	Revisions	Date	By/Par

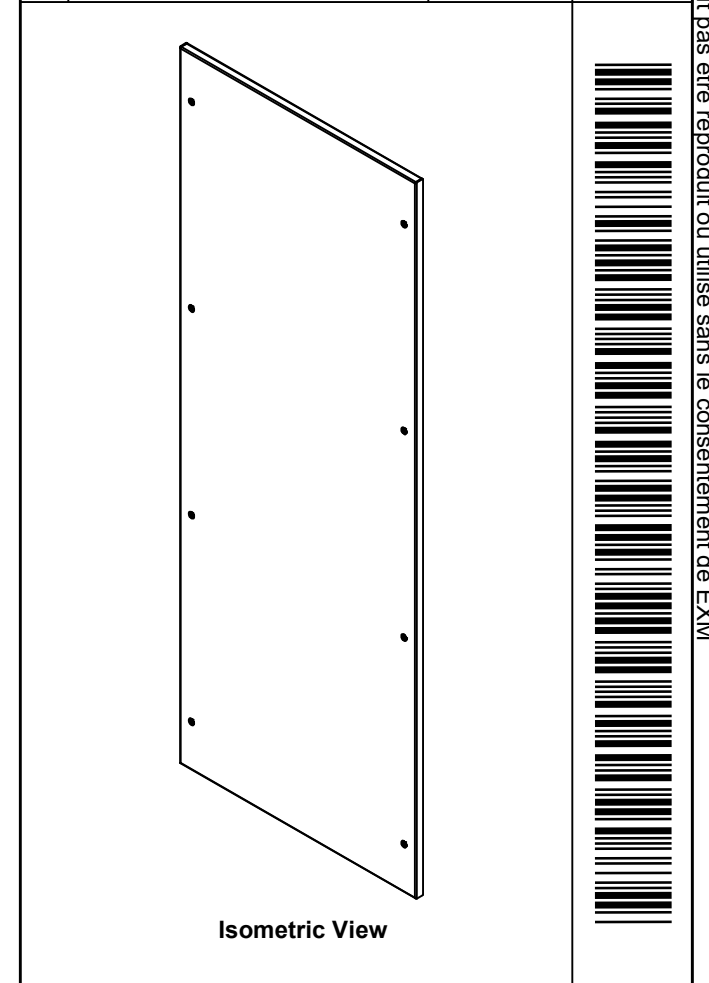

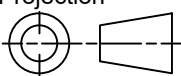
 Tél: (450) 979-4373 Fax: (450) 979-4626 <a href="http://www.exmweb.com">www.exmweb.com</a>		Flatness Aplatissement Max 3.0mm Projection 
Customer Client	Date	
Drawn By / Dessiné Par: BoxCad: BoxCad	Date: 04-Mar-15	
Material / Matière: 14 Ga Cold Rolled A1008 CS Type B		
Color / Couleur: Light Grey RAL7035	Finish / Fini: Textured	
Description: 6500 MXR 1600mm x 600mm Back		Detail Rev.
Part Number / Numéro Pièce: <b>6500MXU160604B</b>		Rev. 13
		18

Qty	Part Number	Rev	Description
1	STK-P-03820R	0	Powder Paint (Light Grey / Rough Textured)
1	6500MXU160604BG	0	6500 MXR 1600mm x 600mm Back Gasket
8	STK-Q-03071	0	M6 x 16mm Machine Screw
2	STK-Q-16080	0	Ground Stud M6 x 16mm Steel
1	6500MXU160604B-P	0	6500 MXR 1600mm x 600mm Back Part
Parts List			

This drawing is confidential and must not be reproduced or used without the consent of EXM

Ce dessin est confidentiel et ne doit pas être reproduit ou utilisé sans le consentement de EXM

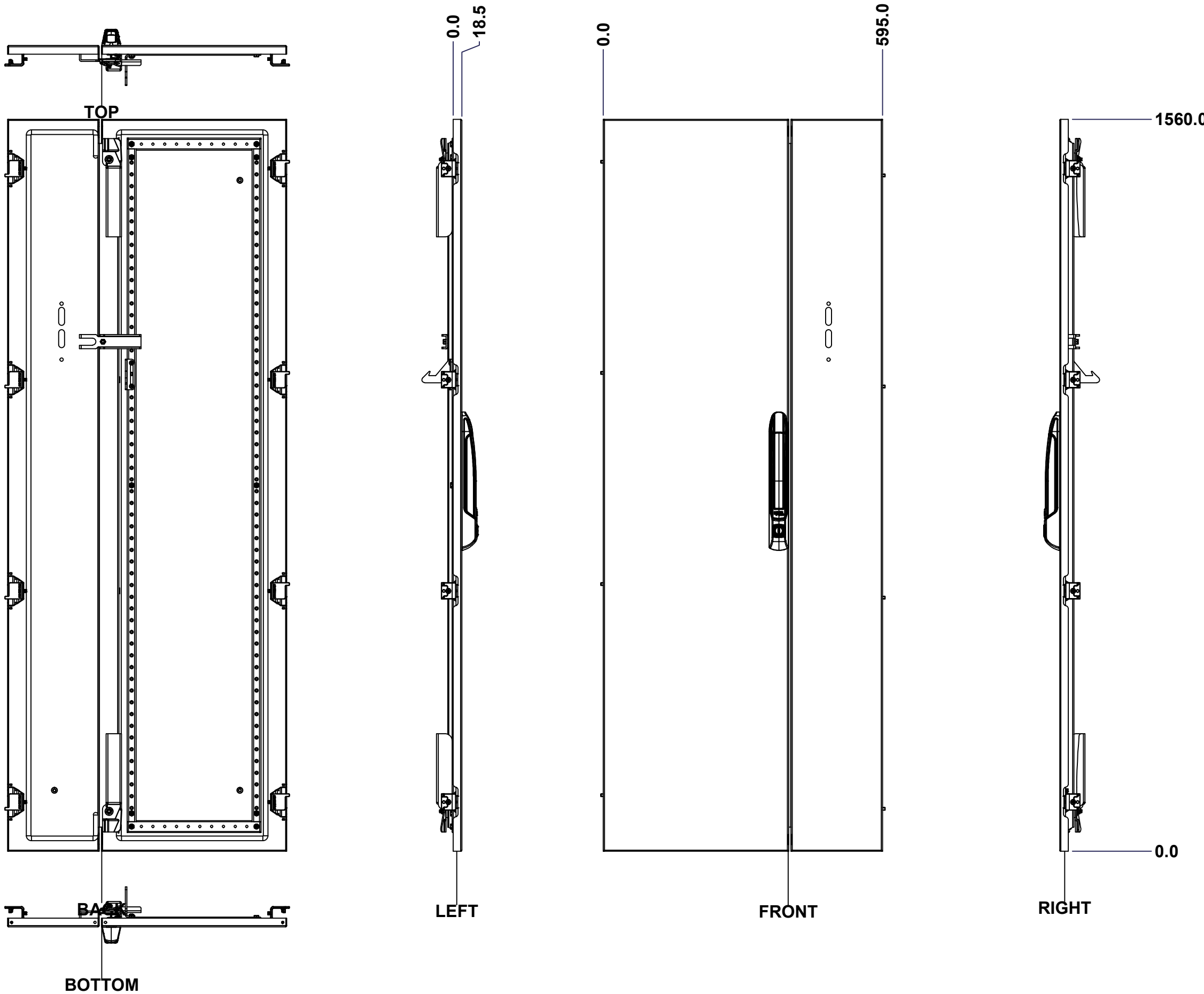

No.	Revisions	Date	By/Par

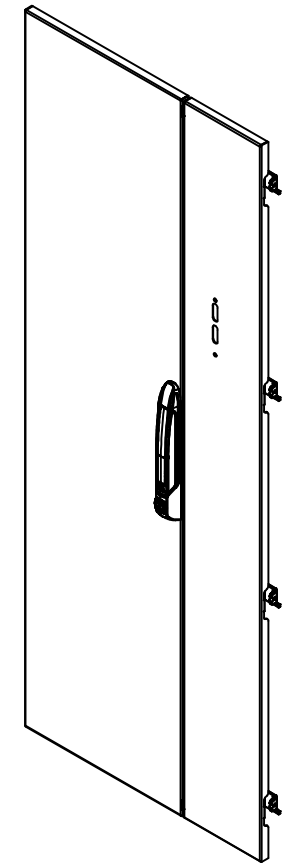

Isometric View

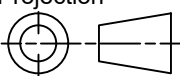

 Tél: (450) 979-4373 Fax: (450) 979-4626 <a href="http://www.exmweb.com">www.exmweb.com</a>	Flatness Aplatissement	Max 3.0mm
	Projection	
Customer Client	Date	
Drawn By Dessiné Par BoxCad: BoxCad	Date	04-Mar-15
Material Matière	14 Ga Cold Rolled A1008 CS Type B	
Color Couleur	Light Grey RAL7035	Finish Fini Textured
Description	6500 MXDU 1600mm x 600mm Front	
Part Number Numéro Pièce	Rev.	14
<b>6500MXU160604F</b>	<b>0</b>	18

Use gasket program path 6500 MX > 6500 MXDU

SEE BILL OF MATERIAL ON LAST PAGE

This drawing is confidential and must not be reproduced or used without the consent of EXM

Ce dessin est confidentiel et ne doit pas être reproduit ou utilisé sans le consentement de EXM

**STANDARD FEATURES ARE NOT LISTED IN THIS HOLE TABLE**

**HOLE TABLE - FRONT VIEW (CUSTOM FEATURE ONLY)**

CUT-OUT	XDIM	YDIM	DESCRIPTION
1	100.0	130.0	GND STUD M6 x 16mm (Inside)
2	100.0	1430.0	GND STUD M6 x 16mm (Inside)
3	495.0	130.0	GND STUD M6 x 16mm (Inside)
4	64.5	52.8	STIFF. STUD M6 x 18mm (Inside)
5	64.5	780.0	STIFF. STUD M6 x 18mm (Inside)
6	64.5	1507.2	STIFF. STUD M6 x 18mm (Inside)
7	64.5	1479.0	STIFF. STUD M6 x 18mm (Inside)
8	64.5	81.0	STIFF. STUD M6 x 18mm (Inside)
9	330.5	52.8	STIFF. STUD M6 x 18mm (Inside)
10	330.5	780.0	STIFF. STUD M6 x 18mm (Inside)
11	330.5	1507.2	STIFF. STUD M6 x 18mm (Inside)
12	330.5	1479.0	STIFF. STUD M6 x 18mm (Inside)
13	330.5	81.0	STIFF. STUD M6 x 18mm (Inside)
14	374.0	170.0	LARGE CBAR GUIDE (Inside)
15	374.0	1390.0	LARGE CBAR GUIDE (Inside)
16	374.0	605.0	LARGE CBAR GUIDE (Inside)
17	374.0	955.0	LARGE CBAR GUIDE (Inside)

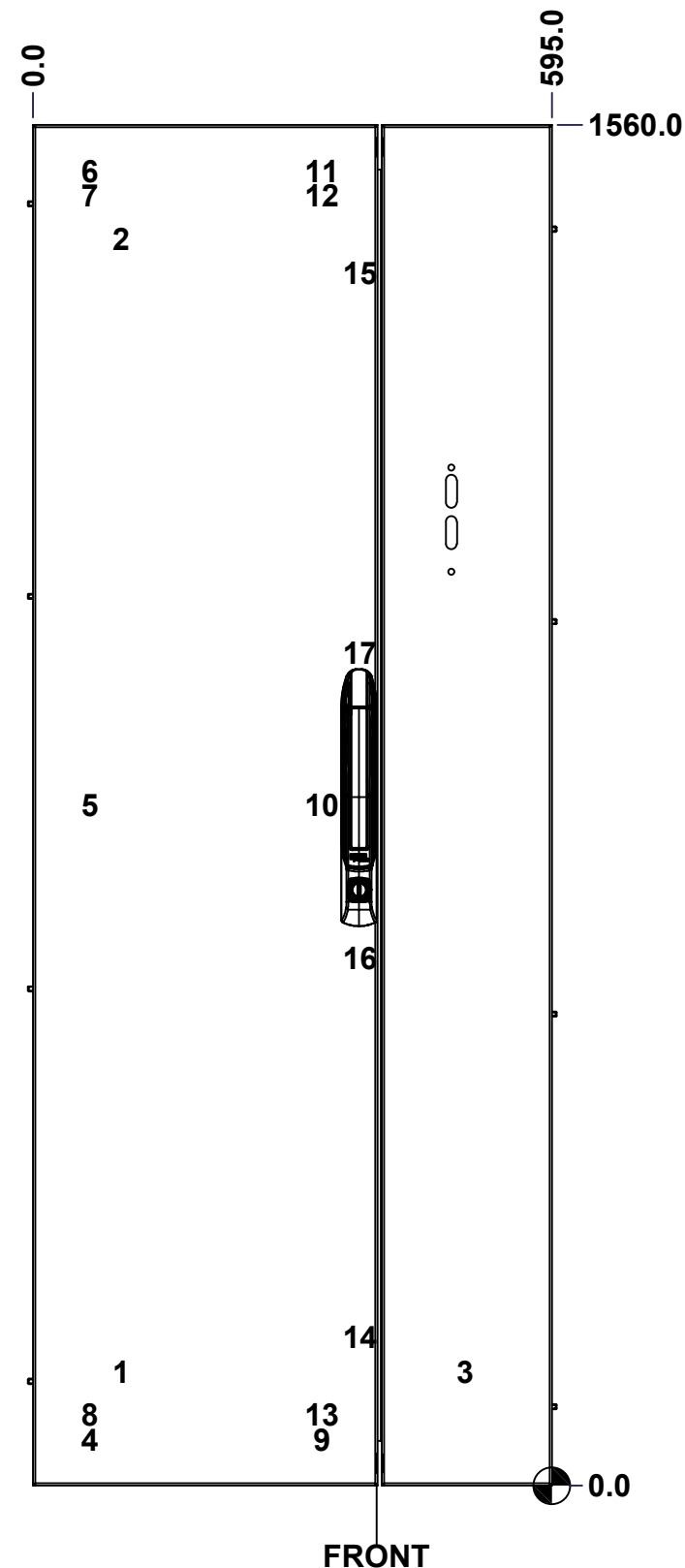

Use bending program path 6500 MX > 6500 MXDU

	Description		Status
	6500 MXDU 1600mm x 600mm Front		(NULL)
	Part Number Numéro Pièce		Rev.
	<b>6500MXU160604F</b>		<b>0</b> / 15

This drawing is confidential and must not be reproduced or used without the consent of EXM

Ce dessin est confidentiel et ne doit pas être reproduit ou utilisé sans le consentement de EXM

No.	Revisions	Date	By/Par

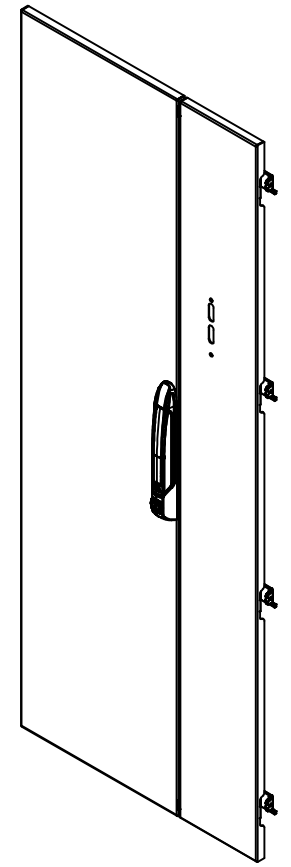

Isometric View



1	STK-P-03820R	0	Powder Paint (Light Grey / Rough Textured)
1	STK-A-51160	0	886PH2-SL - Pull Handle Lock - Assembly
1	STK-Q-45758	1	886 PH2 Pull Handle Bridge Part
4	STK-Q-16410	0	Guide Stud - Large (No Paint Cap Required)
4	STK-A-70586	3	Fixed Double Door Bracket Assembly
1	STK-Q-45652-16	1	6500 MX - Lower Closing Bar 1600mm
1	STK-Q-45651-16	1	6500 MX - Upper Closing Bar 1600mm
1	STK-Q-46650	3	6500 MXDU Disconnect Hook
8	STK-K-06810	7	6500 MX Hinge Assy
2	STK-Q-05020	5	M5 x 8mm Thread Rolling Screw
1	STK-Q-07220	0	M6 Nylon Insert Lock Nut
1	STK-Q-46750	4	6500 MXDU Disconnect Defeater
1	STK-K-10102	3	6500MX - Lock Handle Kit for Flange Door - Right
1	STK-K-10101	3	6500MX - Lock Handle Kit for Flange Door - Left
1	STK-Q-16030	0	Stud M6 x 10mm
2	STK-Q-16050	0	Stud M6 x 18mm
1	6500MXU160604F1G	0	6500 MXDU 1600mm x 600mm Front Gasket
1	6500MXU160604F1-P	0	6500 MXDU 1600mm x 600mm Front Part
10	STK-Q-16055	1	M6 x 18mm Stud (No Paint Cap Required)
3	STK-Q-16080	0.1.1	Ground Stud M6 x 16mm Steel
1	6500MXU160604DS1	5	6500 MX 1600mm x 600mm Door Stiffener
1	6500MXU160604FG	0	6500 MXDU 1600mm x 600mm Front Gasket
1	6500MXU160604F-P	0	6500 MXDU 1600mm x 600mm Front Part

Qty	Part Number	Rev.	Description
Parts List			

	Tél: (450) 979-4373 Fax: (450) 979-4626 <a href="http://www.exmweb.com">www.exmweb.com</a>	Flatness Aplatissement Max 3.0mm
	Projection 	Customer Client
Drawn By Dessiné Par	BoxCad: BoxCad	Date 04-Mar-15
Material Matière	14 Ga Cold Rolled A1008 CS Type B	
Color Couleur	Light Grey RAL7035	Finish Fini Textured
Description 6500 MXDU 1600mm x 600mm Front	Detail Rev.	
Part Number Numéro Pièce <b>6500MXU160604F</b>	Rev. <b>0</b>	16 18

This drawing is confidential and must not be reproduced or used without the consent of EXM

Ce dessin est confidentiel et ne doit pas être reproduit ou utilisé sans le consentement de EXM

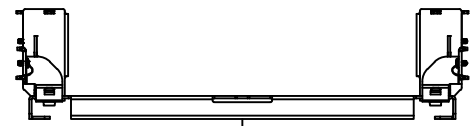

TOP

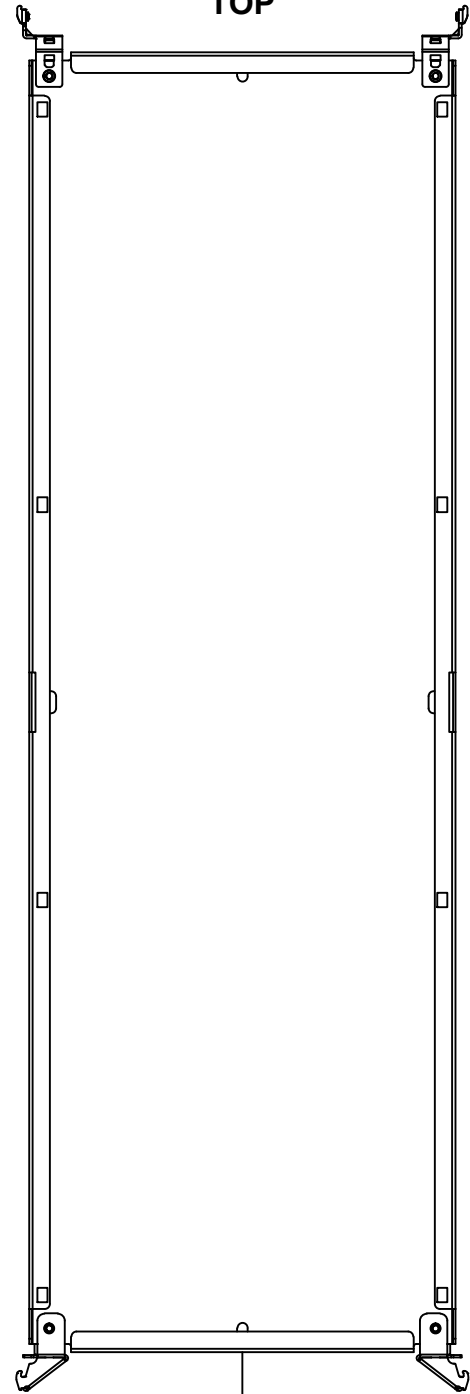

BACK

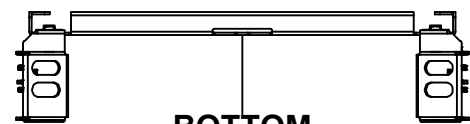

BOTTOM

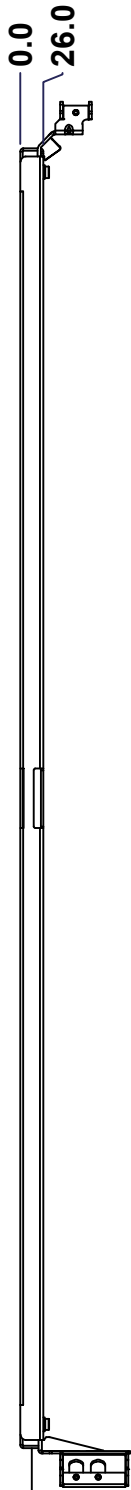

LEFT

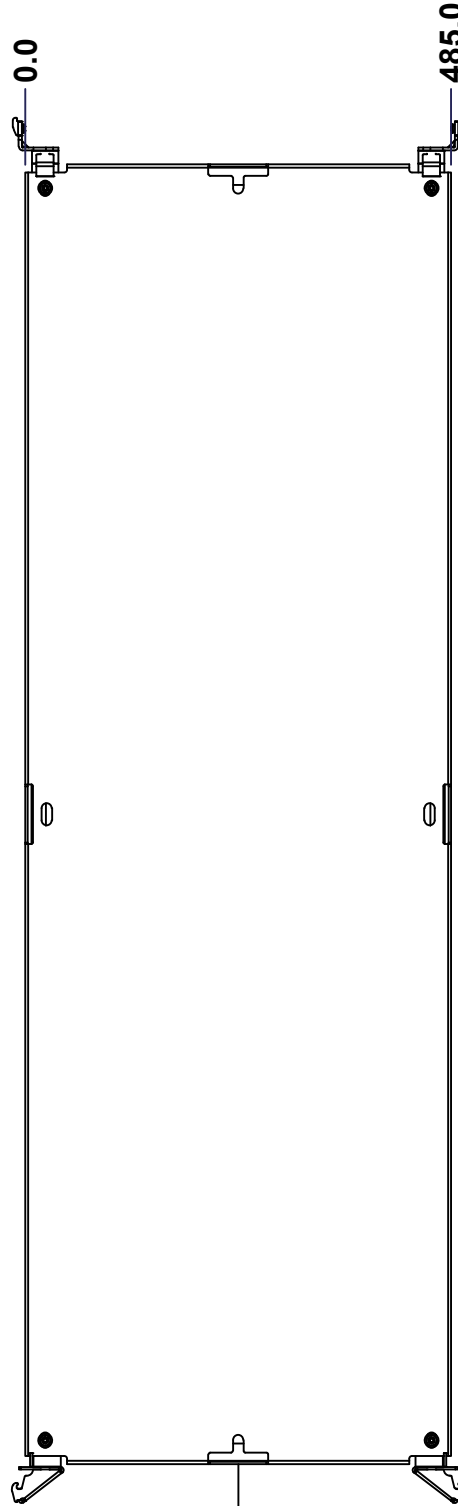

FRONT

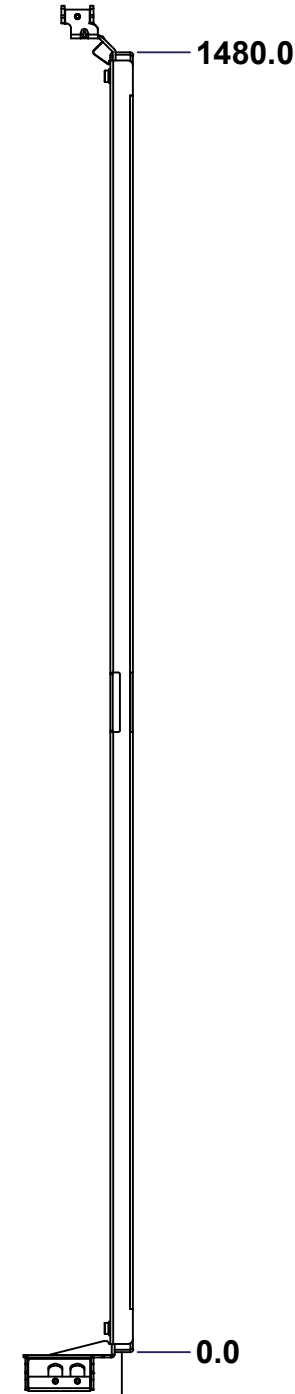

RIGHT

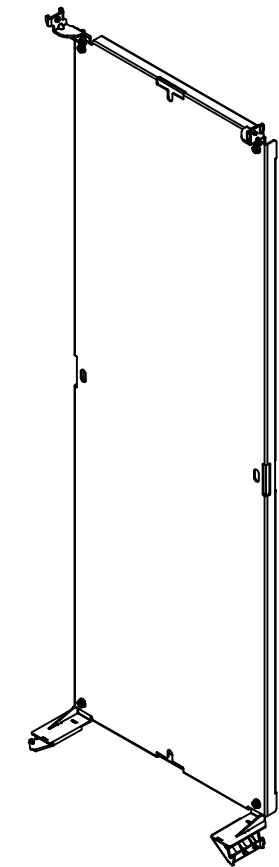

Isometric View

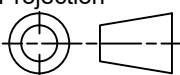

No.	Revisions	Date	By/Par

 Tél: (450) 979-4373 Fax: (450) 979-4626 <a href="http://www.exmweb.com">www.exmweb.com</a>		Flatness Aplatissement Max 3.0mm Projection 
Customer Client	Date	
Drawn By Dessiné Par	BoxCad: BoxCad	Date 04-Mar-15
Material Matière	12 Ga Galvanized (2.5mm)	
Color Couleur	Unpainted	Finish Fini Unpainted
Description	Detail Rev.	
6500 MXM 1600mm x 600mm Back Inner Panel		
Part Number Numéro Pièce	Rev.	17
<b>6500MXU160604BIP</b>	<b>0</b>	18

SEE BILL OF MATERIAL ON LAST PAGE

This drawing is confidential and must not be reproduced or used without the consent of EXM

Ce dessin est confidentiel et ne doit pas être reproduit ou utilisé sans le consentement de EXM

No.	Revisions	Date	By/Par

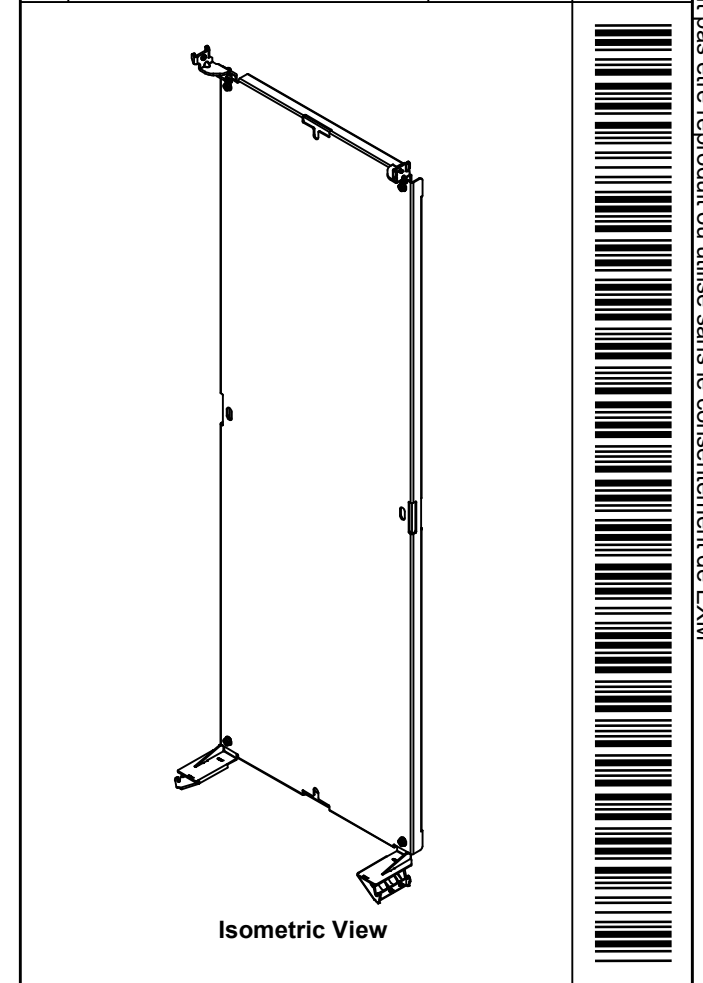

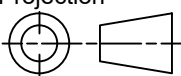
 Tél: (450) 979-4373 Fax: (450) 979-4626 <a href="http://www.exmweb.com">www.exmweb.com</a>		Flatness Aplatissement Max 3.0mm Projection 	
Customer Client		Date	
Drawn By / Dessiné Par: BoxCad: BoxCad		Date: 04-Mar-15	
Material / Matière: 12 Ga Galvanized (2.5mm)			
Color / Couleur: Unpainted		Finish / Fini: Unpainted	
Description: 6500 MXM 1600mm x 600mm Back Inner Panel			Detail Rev.
Part Number / Numéro Pièce: <b>6500MXU160604BIP</b>		Rev.:	18
		<b>0</b>	18

Qty	Part Number	Rev	Description
1	STK-A-49005	5	6500 MXM - Bottom Inner Panel Support Assembly (Right)
1	STK-A-49000	5	6500 MXM - Bottom Inner Panel Support Assembly (Left)
1	STK-A-49015	0	6500MXM - Top Inner Panel Support Kit (Right)
1	STK-A-49010	0	6500MXM - Top Inner Panel Support Kit (Left)
1	6500MXU160604BIP-P	0	6500 MXM 1600mm x 600mm Back Inner Panel Part
Parts List			