

This drawing is confidential and must not be reproduced or used without the consent of EXM

Ce dessin est confidentiel et ne doit pas être reproduit ou utilisé sans le consentement de EXM

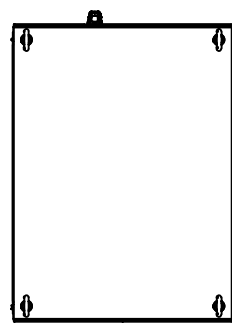

TOP

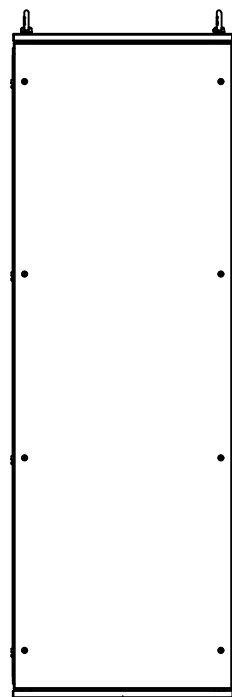

BACK

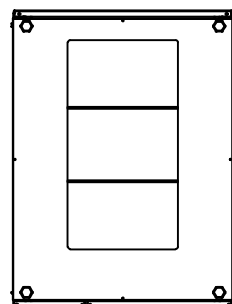

BOTTOM

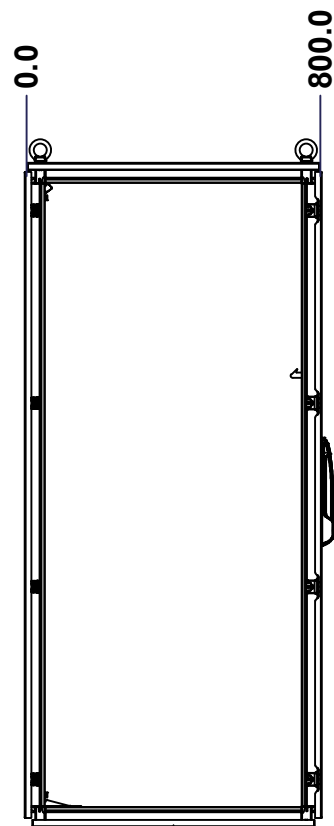

LEFT

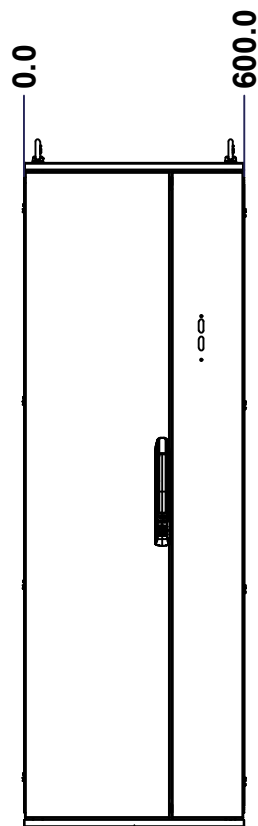

FRONT

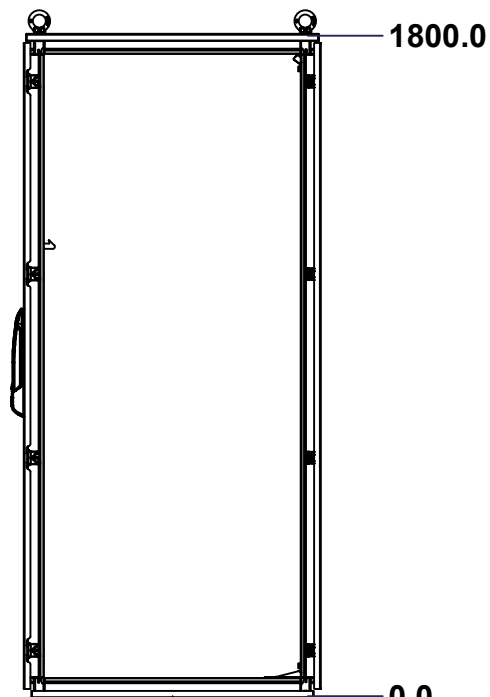

RIGHT

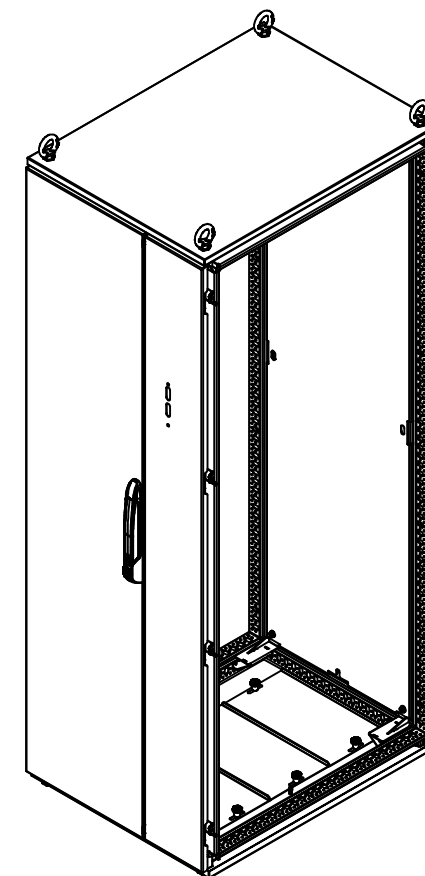

Isometric View

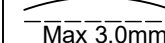
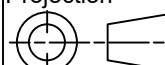

No.	Revisions	Date	By/Par

 Tél: (450) 979-4373 Fax: (450) 979-4626 www.exmweb.com		Flatness Aplatissement  Max 3.0mm Projection 
Customer Client		Date
Drawn By Dessiné Par	BoxCad: BoxCad	Date 05-Mar-15
Material Matière	See Part List	
Color Couleur	See Part List	Finish Fini See Part List
Description	Detail Rev.	
6500MX 1800mm x 600mm x 800mm Assembly		
Part Number Numéro Pièce	Rev.	1
6500MXU180608	0	18

SEE BILL OF MATERIAL ON LAST PAGE

This drawing is confidential and must not be reproduced or used without the consent of EXM

Ce dessin est confidentiel et ne doit pas être reproduit ou utilisé sans le consentement de EXM

No.	Revisions	Date	By/Par

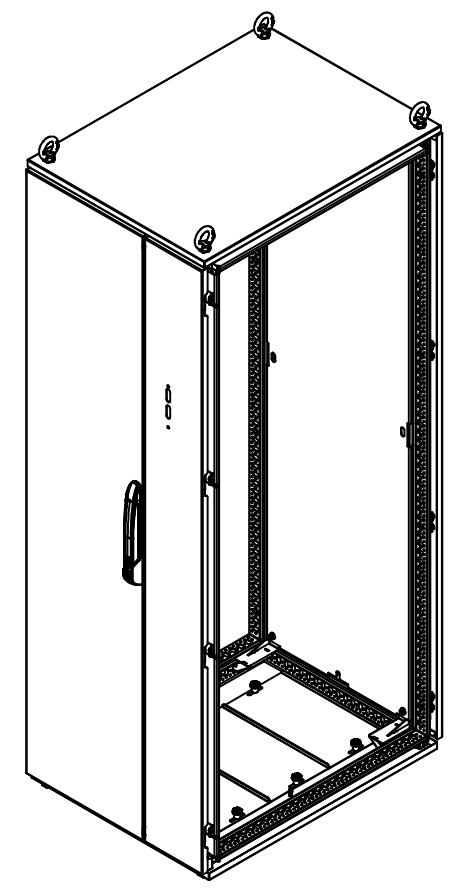

Isometric View



Tél: (450) 979-4373
 Fax: (450) 979-4626
www.exmweb.com

Flatness
Aplatissement
Max 3.0mm
Projection

Customer Client	Date
Drawn By / Dessiné Par: BoxCad: BoxCad	Date: 05-Mar-15
Material / Matière	See Part List

Color / Couleur	See Part List	Finish / Fini	See Part List
Description		Detail Rev.	
6500MX 1800mm x 600mm x 800mm Assembly			

Part Number / Numéro Pièce	Rev.	2
6500MXU180608	0	18

Qty	Part Number	Rev	Description
1	6500MXU180608BIP	0	6500 MXM 1800mm x 600mm Back Inner Panel
1	6500MXU180608F	0	6500 MXDU 1800mm x 600mm Front
1	6500MXU180608B	0	6500 MXR 1800mm x 600mm Back
1	6500MXU180608BT	0	6500 MXB 600mm x 800mm Bottom
1	6500MXU180608T	0	6500 MXT 600mm x 800mm Top
1	6500MXU180608FR	0	6500 MX 1800mm x 600mm x 800mm Frame
Parts List			

This drawing is confidential and must not be reproduced or used without the consent of EXM

Ce dessin est confidentiel et ne doit pas être reproduit ou utilisé sans le consentement de EXM

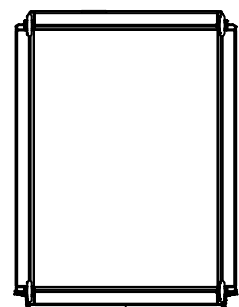

TOP

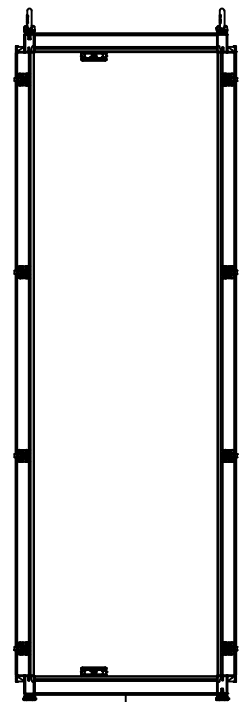

BACK

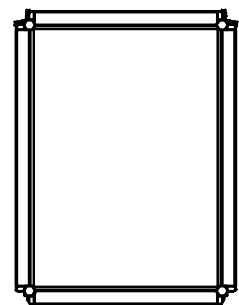

BOTTOM

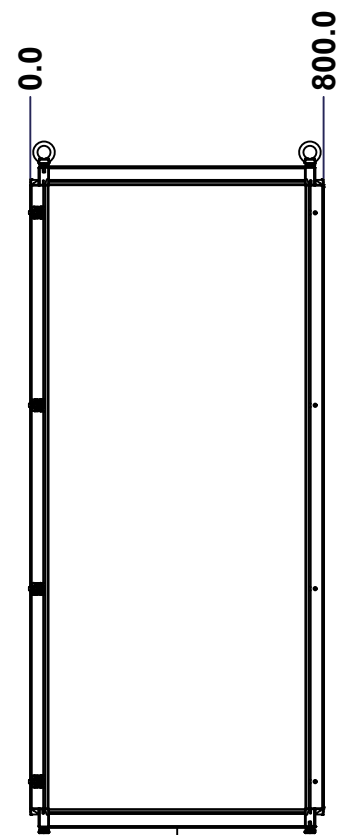

LEFT

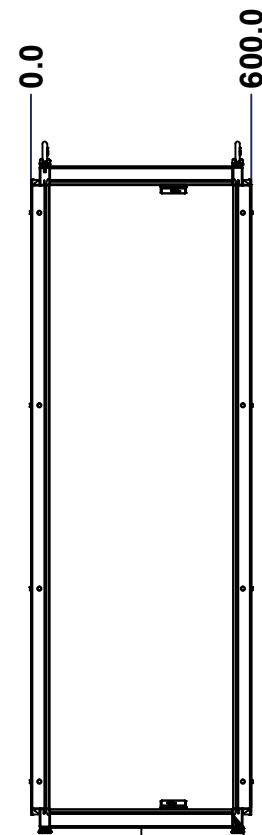

FRONT

Grind excess weld off corner(s)

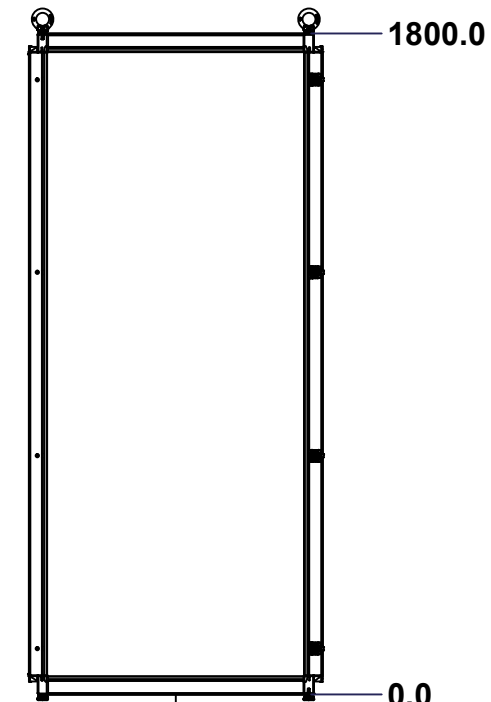

RIGHT

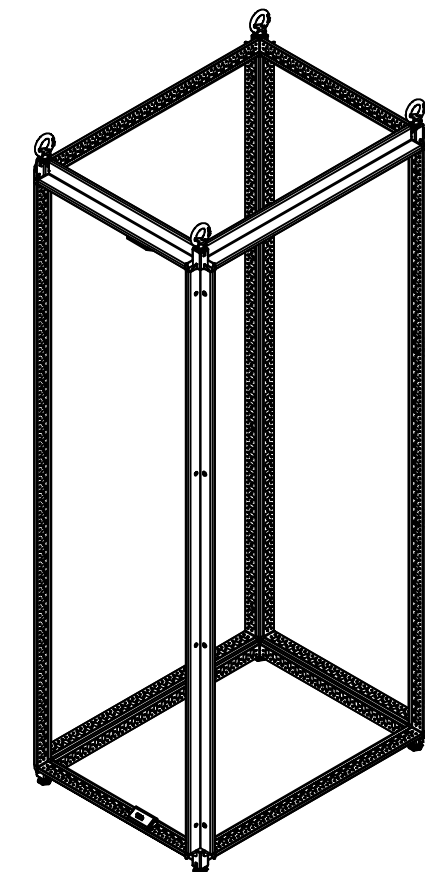

Isometric View

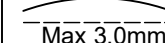
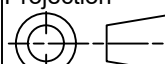

No.	Revisions	Date	By/Par

 Tél: (450) 979-4373 Fax: (450) 979-4626 www.exmweb.com		Flatness Aplatissement  Max 3.0mm Projection 
Customer Client		Date
Drawn By Dessiné Par	BoxCad: BoxCad	Date 05-Mar-15
Material Matière	16 Ga Electro-Galvanized (1.4mm)	
Color Couleur	Iron Grey RAL7011	Finish Fini Textured
Description	Detail Rev.	
6500 MX 1800mm x 600mm x 800mm Frame		
Part Number Numéro Pièce	Rev.	
6500MXU180608FR	0	3 18

SEE BILL OF MATERIAL ON LAST PAGE

This drawing is confidential and must not be reproduced or used without the consent of EXM

Ce dessin est confidentiel et ne doit pas être reproduit ou utilisé sans le consentement de EXM

No.	Revisions	Date	By/Par

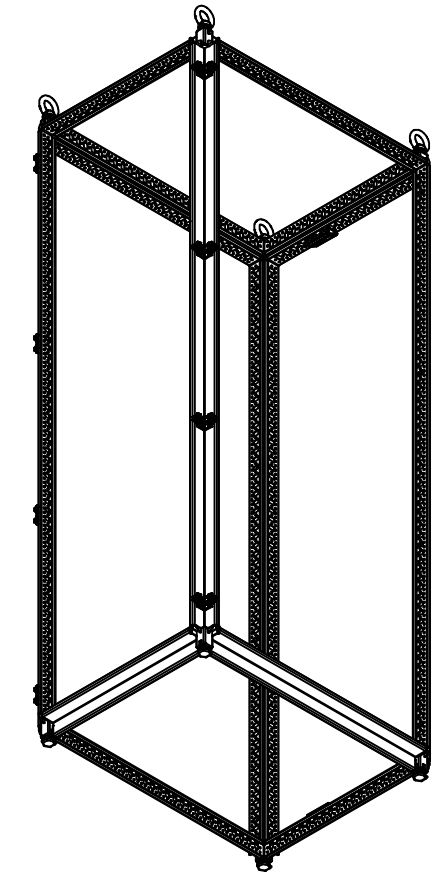

Isometric View



Qty	Part Number	Rev	Description
1	STK-P-03810ST	0	Powder Paint (Iron Grey /Sand Textured)
4	STK-Q-47250-06	6	6500 MX 600mm Horizontal Frame Post Part
4	STK-Q-47250-08	6	6500 MX 800mm Horizontal Frame Post Part
2	STK-Q-05020	5	M5 x 8mm Thread Rolling Screw
2	STK-A-74730	2	6500 MX - Flange Door Sealing Block
16	STK-Q-77120	1	6500MX-Frame Rubber Plug
8	STK-A-70580	9	Mtrx Bracket
8	STK-Q-00610	3	M16 x 30.0mm Bolt
8	STK-A-49448	6	6500 MX - Frame Sheet Metal Corner Assembly
4	STK-Q-49500	3	M12 Eye Bolt (0.34T)
4	STK-Q-61110	0	M12 Feet Leveler
4	STK-Q-47251-18	6	6500 MX 1800mm Vertical Frame Post Part

		Tél: (450) 979-4373 Fax: (450) 979-4626 www.exmweb.com	Flatness Aplatissement Max 3.0mm Projection
Customer Client		Date	
Drawn By Dessiné Par BoxCad: BoxCad		Date 05-Mar-15	
Material Matière 16 Ga Electro-Galvanized (1.4mm)			
Color Couleur Iron Grey RAL7011		Finish Fini Textured	
Description 6500 MX 1800mm x 600mm x 800mm Frame			Detail Rev.
Part Number Numéro Pièce		Rev.	4
6500MXU180608FR		0	18

This drawing is confidential and must not be reproduced or used without the consent of EXM

Ce dessin est confidentiel et ne doit pas être reproduit ou utilisé sans le consentement de EXM

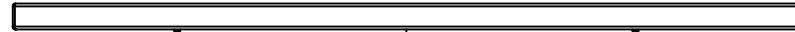

TOP

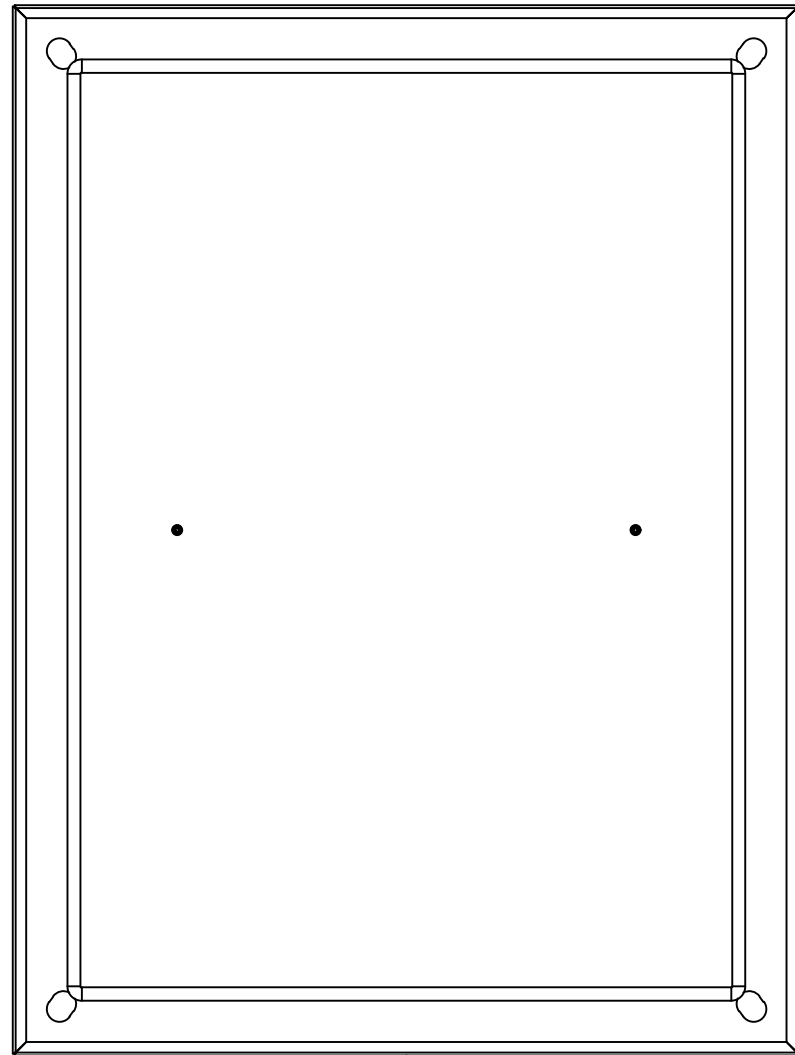

BACK



BOTTOM

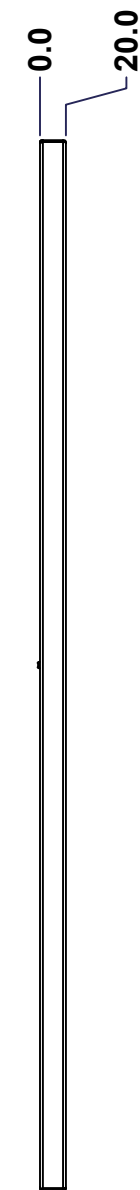

LEFT

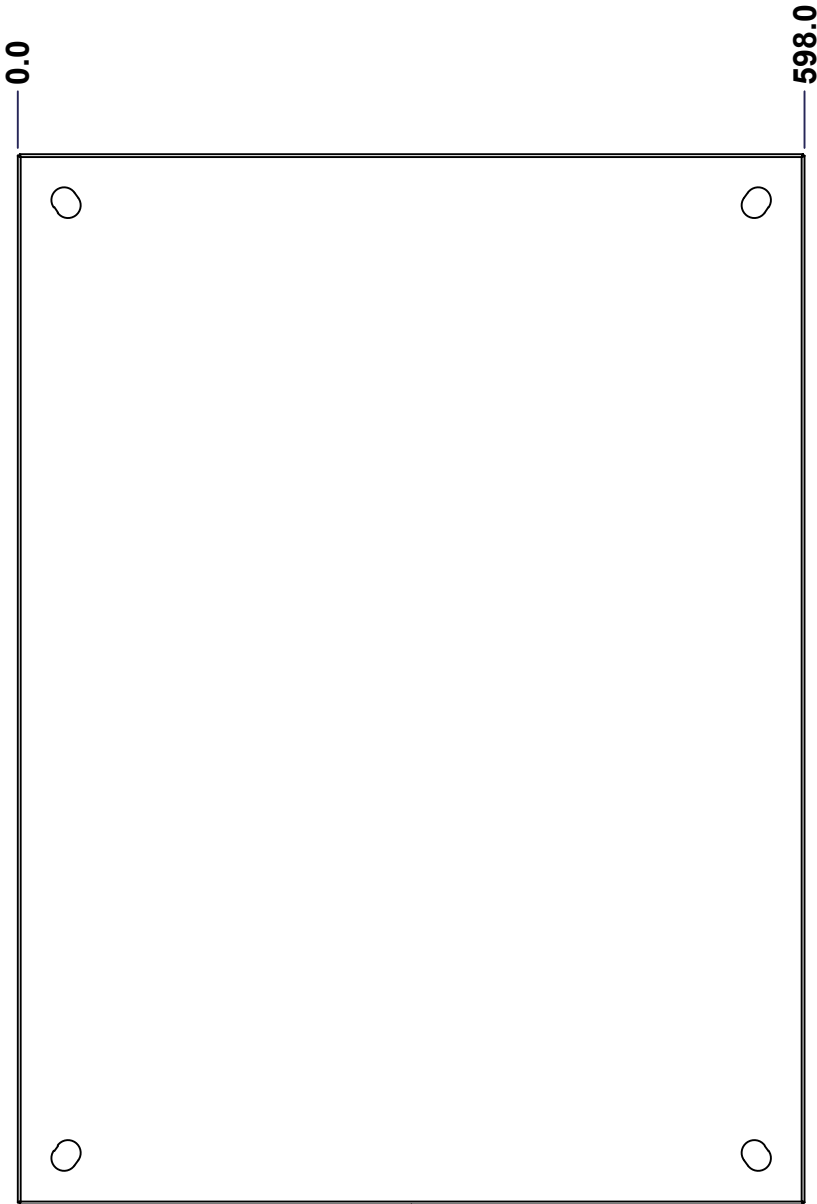

FRONT

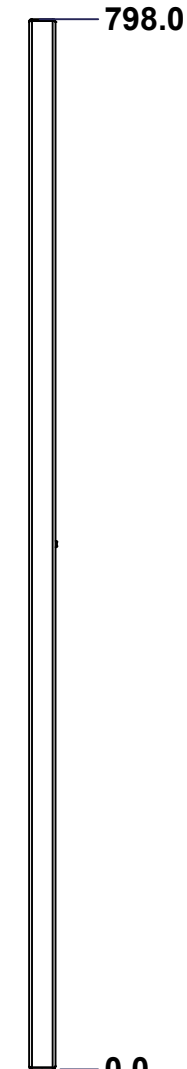

RIGHT

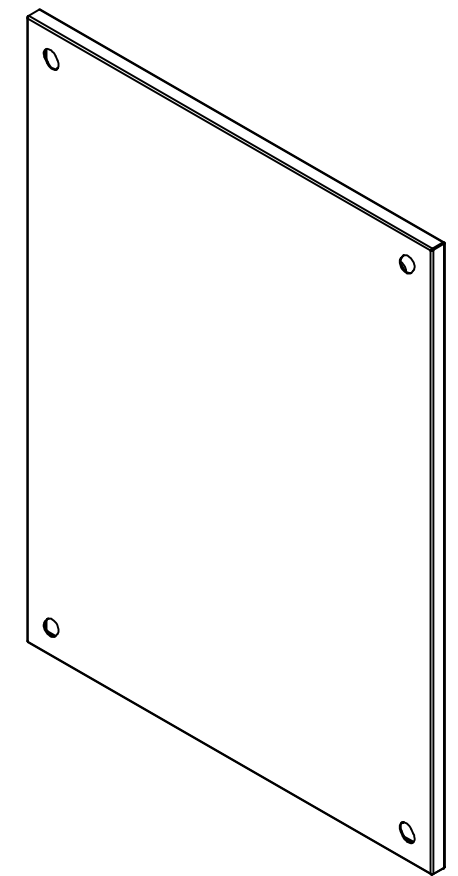

Isometric View

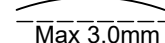
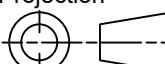

No.	Revisions	Date	By/Par

 Tél: (450) 979-4373 Fax: (450) 979-4626 www.exmweb.com		Flatness Aplatissement  Max 3.0mm Projection 
Customer Client	Date	
Drawn By Dessiné Par	BoxCad: BoxCad	Date 05-Mar-15
Material Matière	16 Ga Cold Rolled A1008 CS Type B	
Color Couleur	Iron Grey RAL7011	Finish Fini Textured
Description	Detail Rev.	
6500 MXT 600mm x 800mm Top		
Part Number Numéro Pièce	Rev.	5
6500MXU180608T	0	18

Use gasket program path 6500 MX > 6500 MXT

SEE BILL OF MATERIAL ON LAST PAGE

This drawing is confidential and must not be reproduced or used without the consent of EXM

Ce dessin est confidentiel et ne doit pas être reproduit ou utilisé sans le consentement de EXM

STANDARD FEATURES ARE NOT LISTED IN THIS HOLE TABLE			
HOLE TABLE - FRONT VIEW (CUSTOM FEATURE ONLY)			
CUT-OUT	XDIM	YDIM	DESCRIPTION
1	125.0	399.0	GND STUD M6 x 18mm (Inside)
2	473.0	399.0	GND STUD M6 x 18mm (Inside)

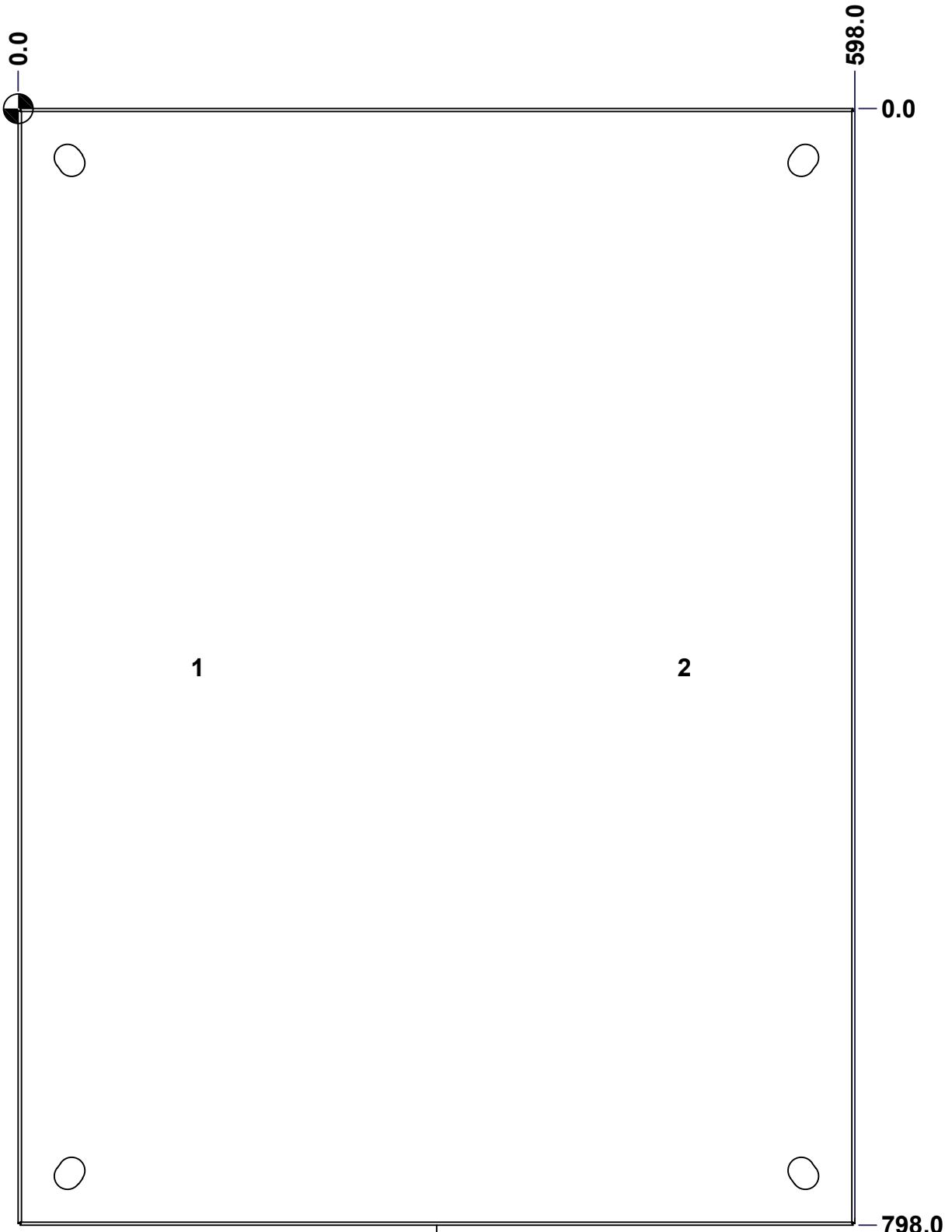

FRONT

Use bending program path 6500 MX > 6500 MXT

	Description		Status
	6500 MXT 600mm x 800mm Top		(NULL)
Part Number Numéro Pièce		Rev.	6
6500MXU180608T		0	18

This drawing is confidential and must not be reproduced or used without the consent of EXM

Ce dessin est confidentiel et ne doit pas être reproduit ou utilisé sans le consentement de EXM

No.	Revisions	Date	By/Par

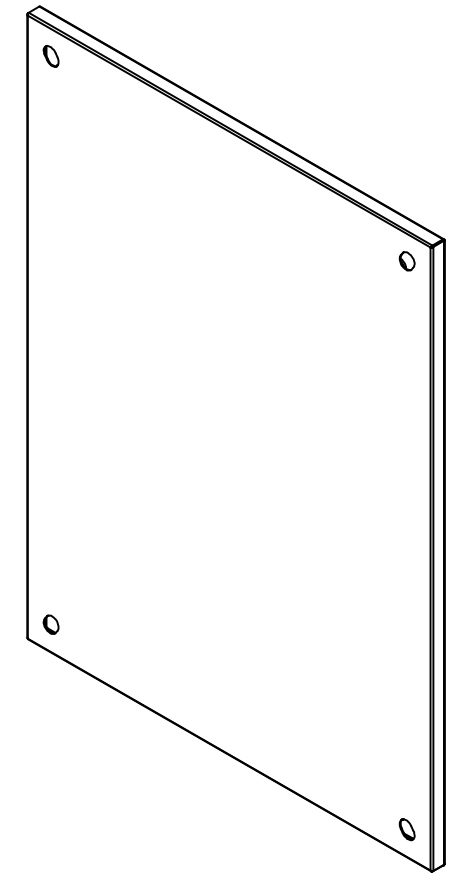

Isometric View

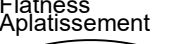

 Tél: (450) 979-4373 Fax: (450) 979-4626 www.exmweb.com		Flatness Aplatissement  Max 3.0mm
Customer Client		Date
Drawn By / Dessiné Par: BoxCad: BoxCad		Date: 05-Mar-15
Material / Matière: 16 Ga Cold Rolled A1008 CS Type B		
Color / Couleur: Iron Grey RAL7011	Finish / Fini: Textured	
Description: 6500 MXT 600mm x 800mm Top		Detail Rev.
Part Number / Numéro Pièce: 6500MXU180608T		Rev. 7 0

Qty	Part Number	Rev	Description
1	STK-P-03810ST	0	Powder Paint (Iron Grey /Sand Textured)
2	STK-Q-16055	1	M6 x 18mm Stud (No Paint Cap Required)
1	6500MXU180608TG	0	6500 MXT 600mm x 800mm Top Gasket
1	6500MXU180608T-P	0	6500 MXT 600mm x 800mm Top Part
Parts List			

This drawing is confidential and must not be reproduced or used without the consent of EXM

Ce dessin est confidentiel et ne doit pas être reproduit ou utilisé sans le consentement de EXM

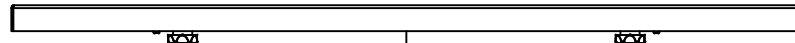

TOP

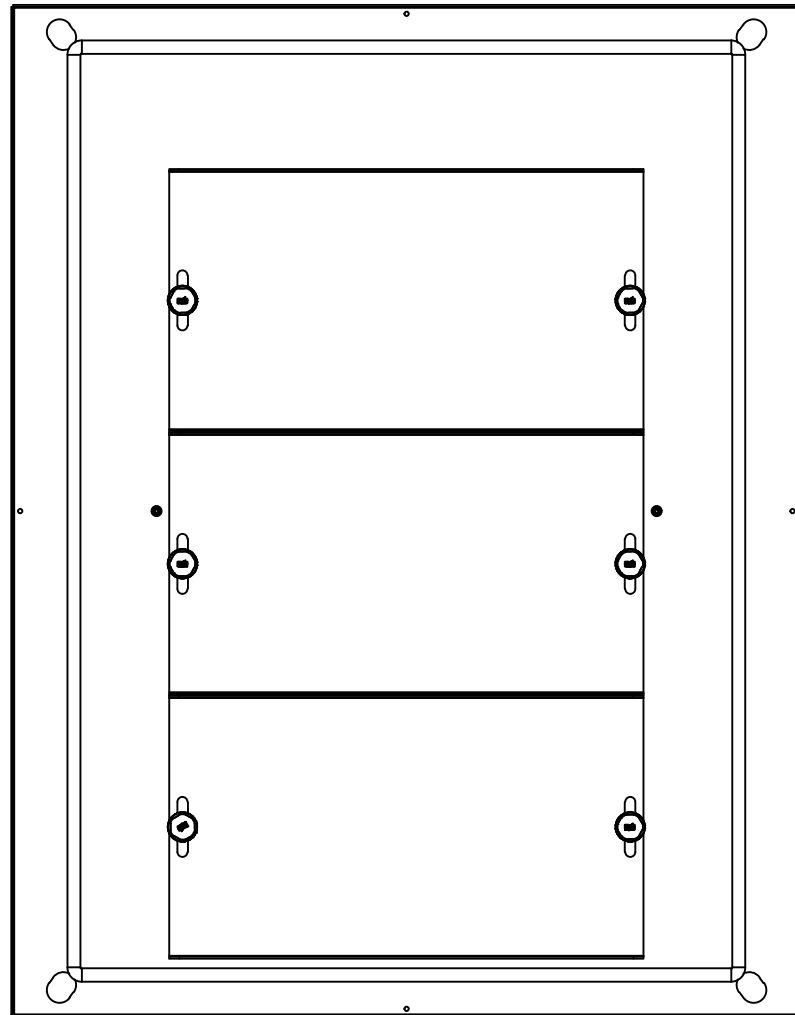

BACK



BOTTOM

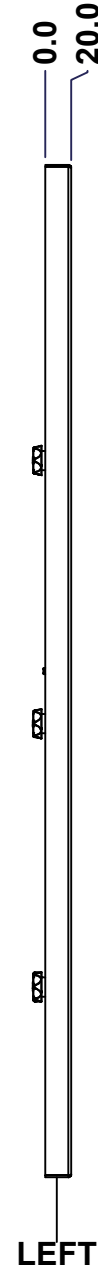

LEFT

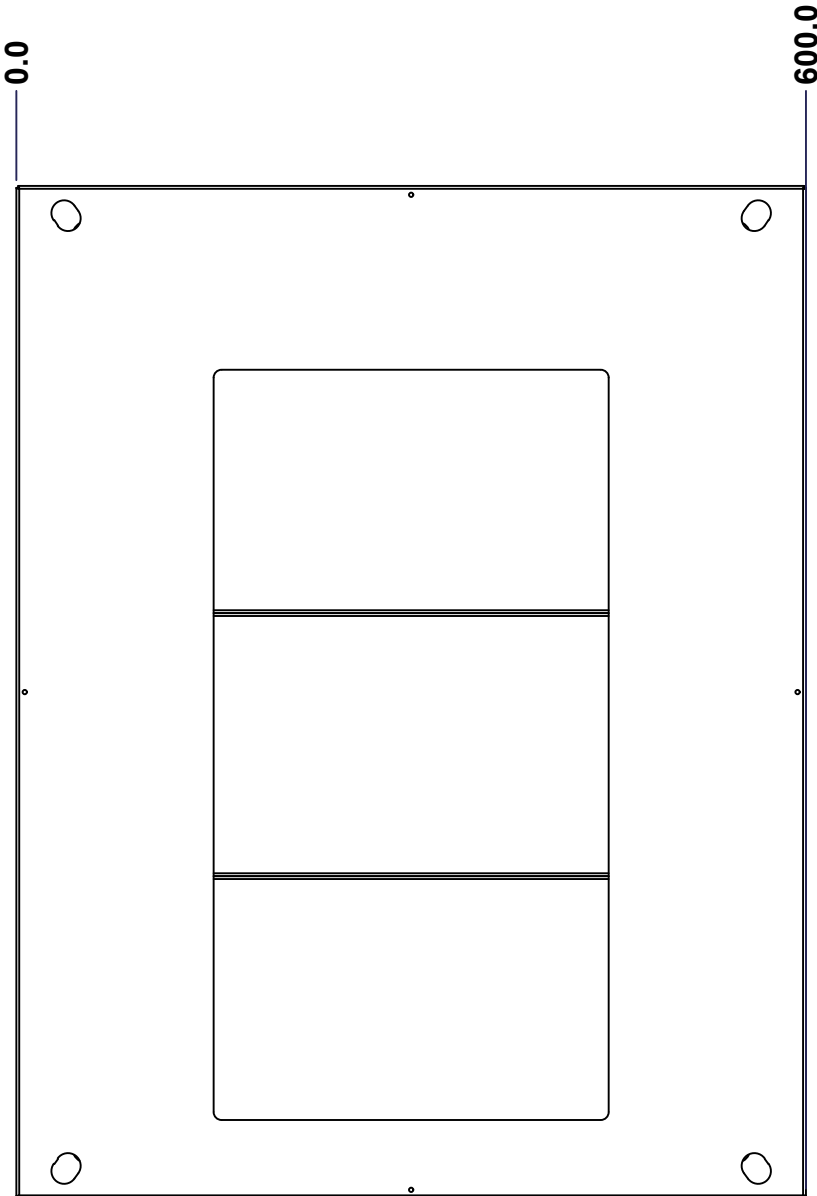

FRONT

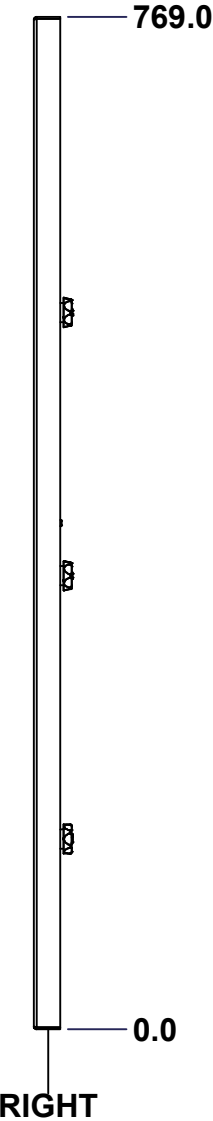

RIGHT

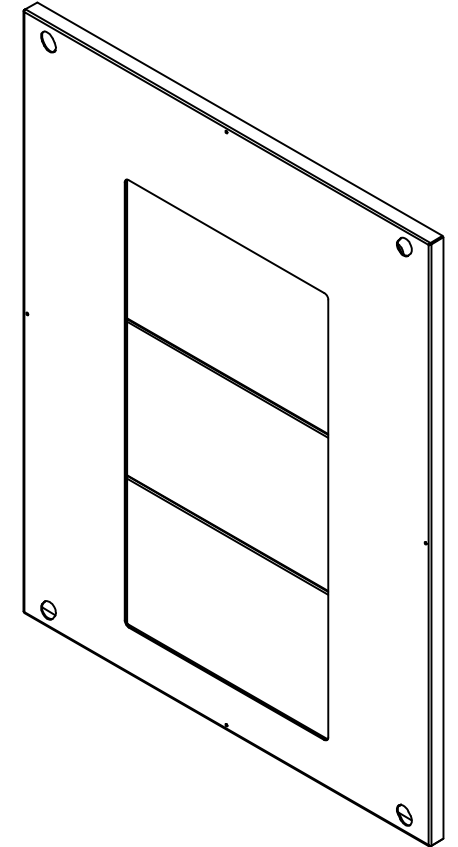

Isometric View

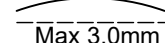
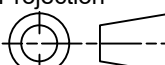

No.	Revisions	Date	By/Par

 Tél: (450) 979-4373 Fax: (450) 979-4626 www.exmweb.com		Flatness Aplatissement  Max 3.0mm Projection 
Customer Client	Date	
Drawn By Dessiné Par	BoxCad: BoxCad	Date 05-Mar-15
Material Matière	16 Ga Cold Rolled A1008 CS Type B	
Color Couleur	Iron Grey RAL7011	Finish Fini Textured
Description	Detail Rev.	
6500 MXB 600mm x 800mm Bottom		
Part Number Numéro Pièce	Rev.	8
6500MXU180608BT	0	18

Use gasket program path 6500 MX > 6500MXB

SEE BILL OF MATERIAL ON LAST PAGE

This drawing is confidential and must not be reproduced or used without the consent of EXM

Ce dessin est confidentiel et ne doit pas être reproduit ou utilisé sans le consentement de EXM

STANDARD FEATURES ARE NOT LISTED IN THIS HOLE TABLE

HOLE TABLE - FRONT VIEW (CUSTOM FEATURE ONLY)

CUT-OUT	XDIM	YDIM	DESCRIPTION
1	110.0	384.5	GND STUD M6 x 18mm (Inside)
2	490.0	384.5	GND STUD M6 x 18mm (Inside)
3	130.0	544.5	GP STUD M6 x 18mm (Inside)
4	470.0	544.5	GP STUD M6 x 18mm (Inside)
5	130.0	344.5	GP STUD M6 x 18mm (Inside)
6	470.0	344.5	GP STUD M6 x 18mm (Inside)
7	130.0	144.5	GP STUD M6 x 18mm (Inside)
8	470.0	144.5	GP STUD M6 x 18mm (Inside)

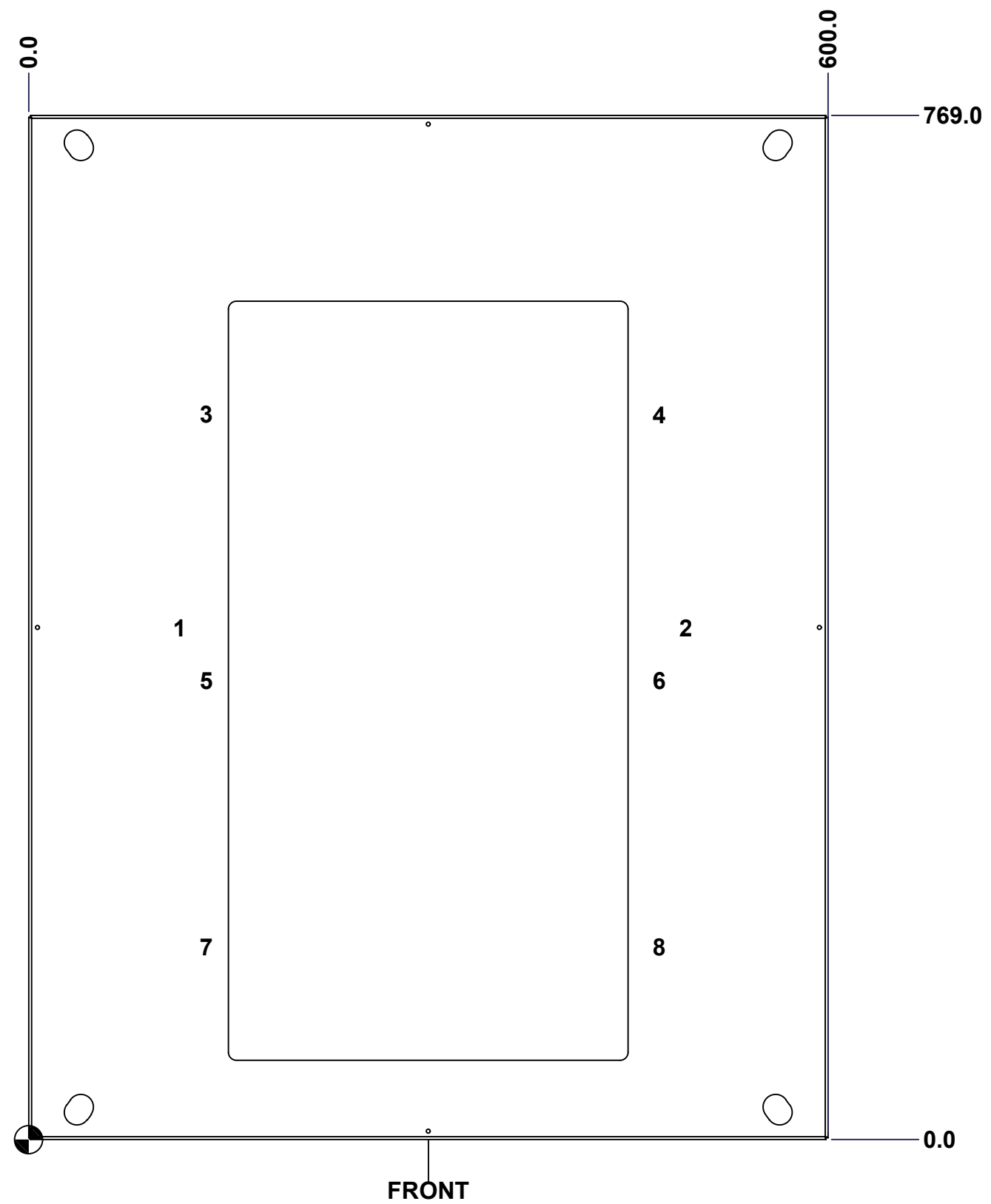

Use bending program path 6500 MX > 6500MXB

	Description		Status
	6500 MXB 600mm x 800mm Bottom		(NULL)
	Part Number Numéro Pièce		Rev.
	6500MXU180608BT		0 / 9
			18

This drawing is confidential and must not be reproduced or used without the consent of EXM

Ce dessin est confidentiel et ne doit pas être reproduit ou utilisé sans le consentement de EXM

No.	Revisions	Date	By/Par

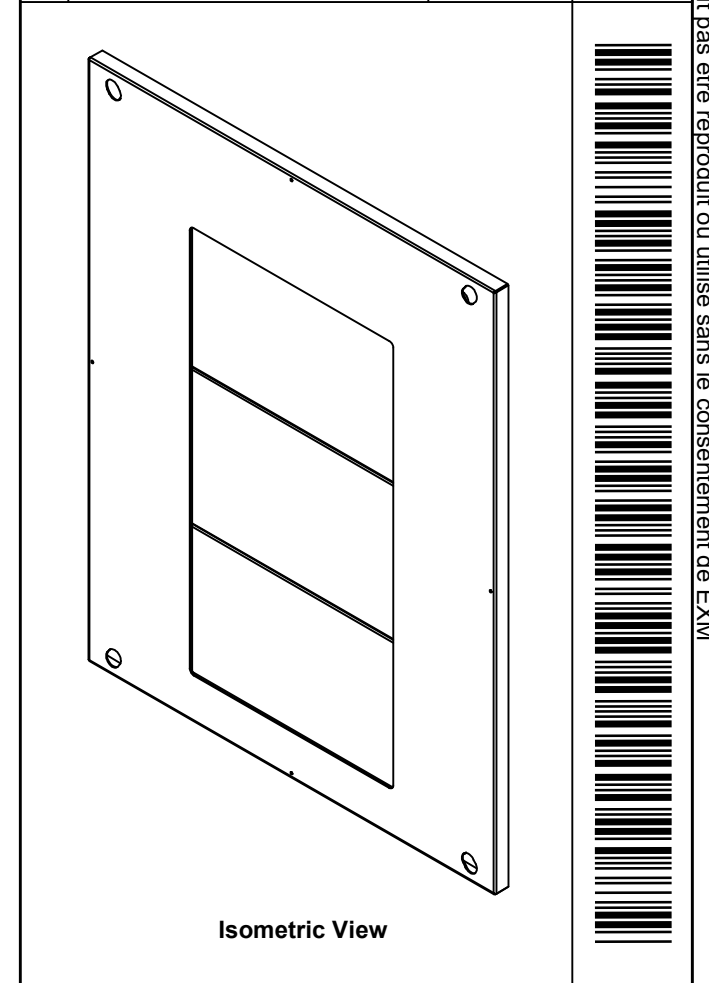

Tél: (450) 979-4373 Fax: (450) 979-4626 www.exmweb.com		Flatness Aplatissement	
		Max 3.0mm Projection	
Customer Client		Date	
Drawn By Dessiné Par		Date 05-Mar-15	
Material Matière		16 Ga Cold Rolled A1008 CS Type B	
Color Couleur		Iron Grey RAL7011	Finish Fini Textured
Description			Detail Rev.
6500 MXB 600mm x 800mm Bottom			
Part Number Numéro Pièce		Rev.	10
6500MXU180608BT		0	18

Qty	Part Number	Rev	Description
1	STK-P-03810ST	0	Powder Paint (Iron Grey /Sand Textured)
6	STK-Q-06001	0	Mtrx - Gland Plate M6 Plastic Thumb Nut
8	STK-Q-16055	1	M6 x 18mm Stud (No Paint Cap Required)
3	6500MXU180608GP200-P	0	6500 MXB 600mm Gland Plate Part (200mm)
1	6500MXU180608BTGPG	0	6500 MXB 600mm x 800mm Bottom Gland Plate Gasket
1	6500MXU180608BTG	0	6500 MXB 600mm x 800mm Bottom Gasket
1	6500MXU180608BT-P	0	6500 MXB 600mm x 800mm Bottom Part
Parts List			

This drawing is confidential and must not be reproduced or used without the consent of EXM

Ce dessin est confidentiel et ne doit pas être reproduit ou utilisé sans le consentement de EXM

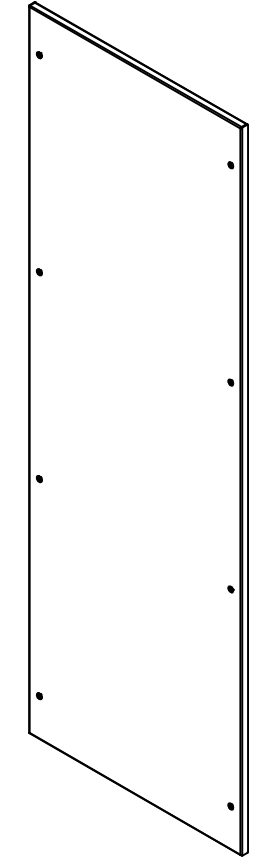
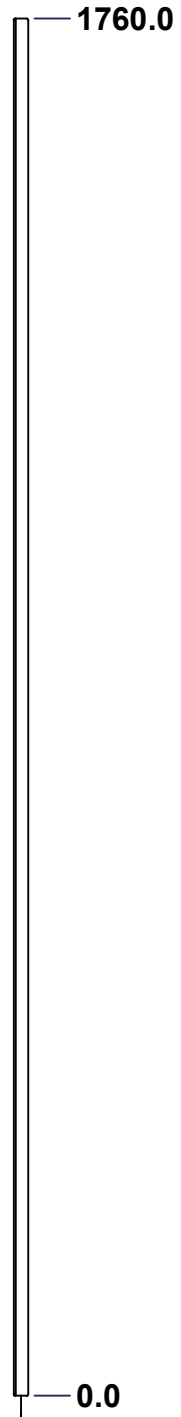
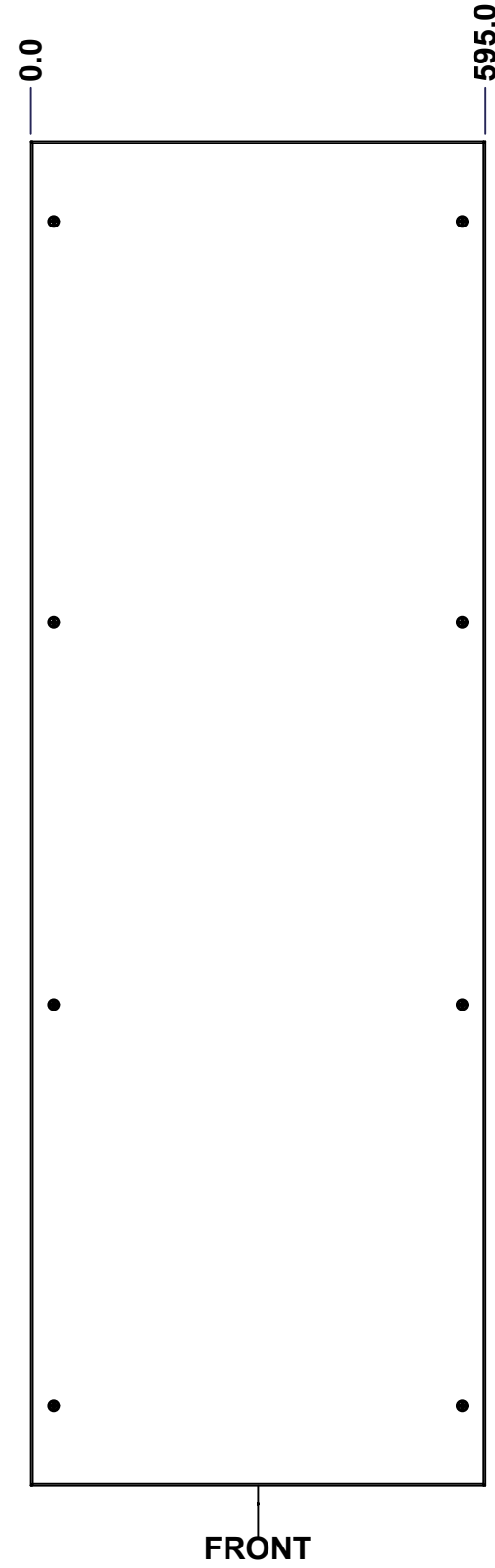
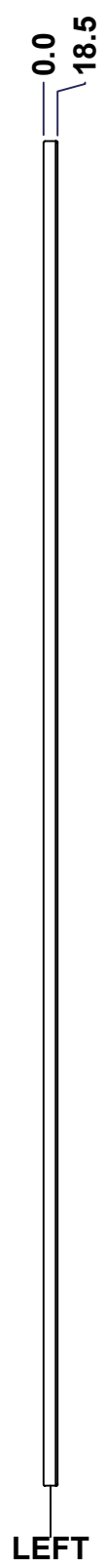
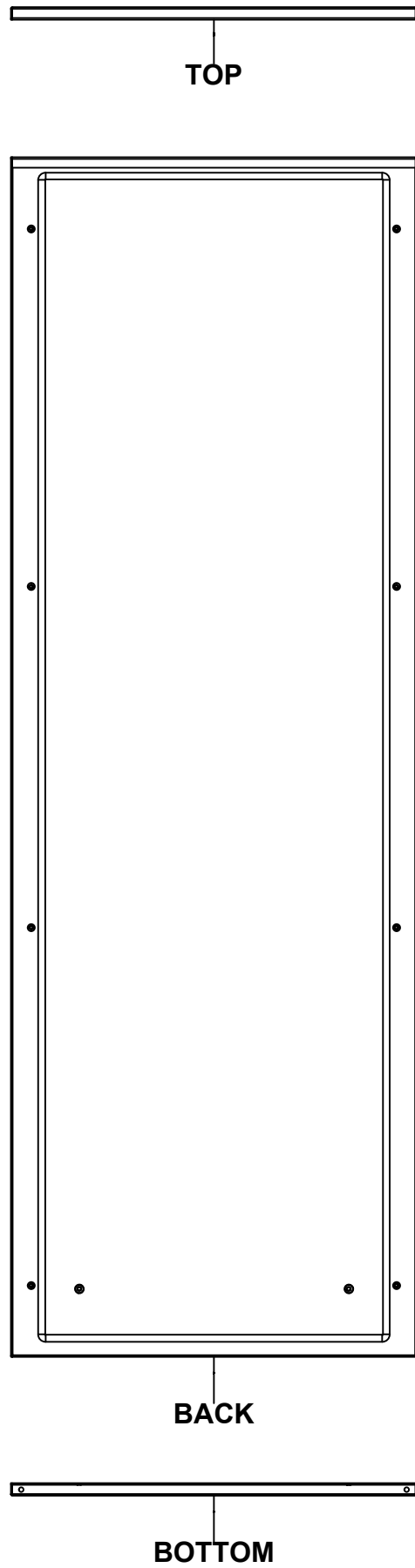

No.	Revisions	Date	By/Par

Isometric View

<p>Tél: (450) 979-4373 Fax: (450) 979-4626 www.exmweb.com</p>		Flatness Aplatissement
		Max 3.0mm
		Projection
Customer Client		Date
Drawn By Dessiné Par	BoxCad: BoxCad	Date 05-Mar-15
Material Matière	14 Ga Cold Rolled A1008 CS Type B	
Color Couleur	Light Grey RAL7035	Finish Fini Textured
Description		Detail Rev.
6500 MXR 1800mm x 600mm Back		
Part Number Numéro Pièce	Rev.	11
6500MXU180608B	0	18

Use gasket program path 6500 MX > 6500 MXR

SEE BILL OF MATERIAL ON LAST PAGE

This drawing is confidential and must not be reproduced or used without the consent of EXM

Ce dessin est confidentiel et ne doit pas être reproduit ou utilisé sans le consentement de EXM

STANDARD FEATURES ARE NOT LISTED IN THIS HOLE TABLE			
HOLE TABLE - FRONT VIEW (CUSTOM FEATURE ONLY)			
CUT-OUT	XDIM	YDIM	DESCRIPTION
1	100.0	100.0	GND STUD M6 x 16mm (Inside)
2	495.0	100.0	GND STUD M6 x 16mm (Inside)

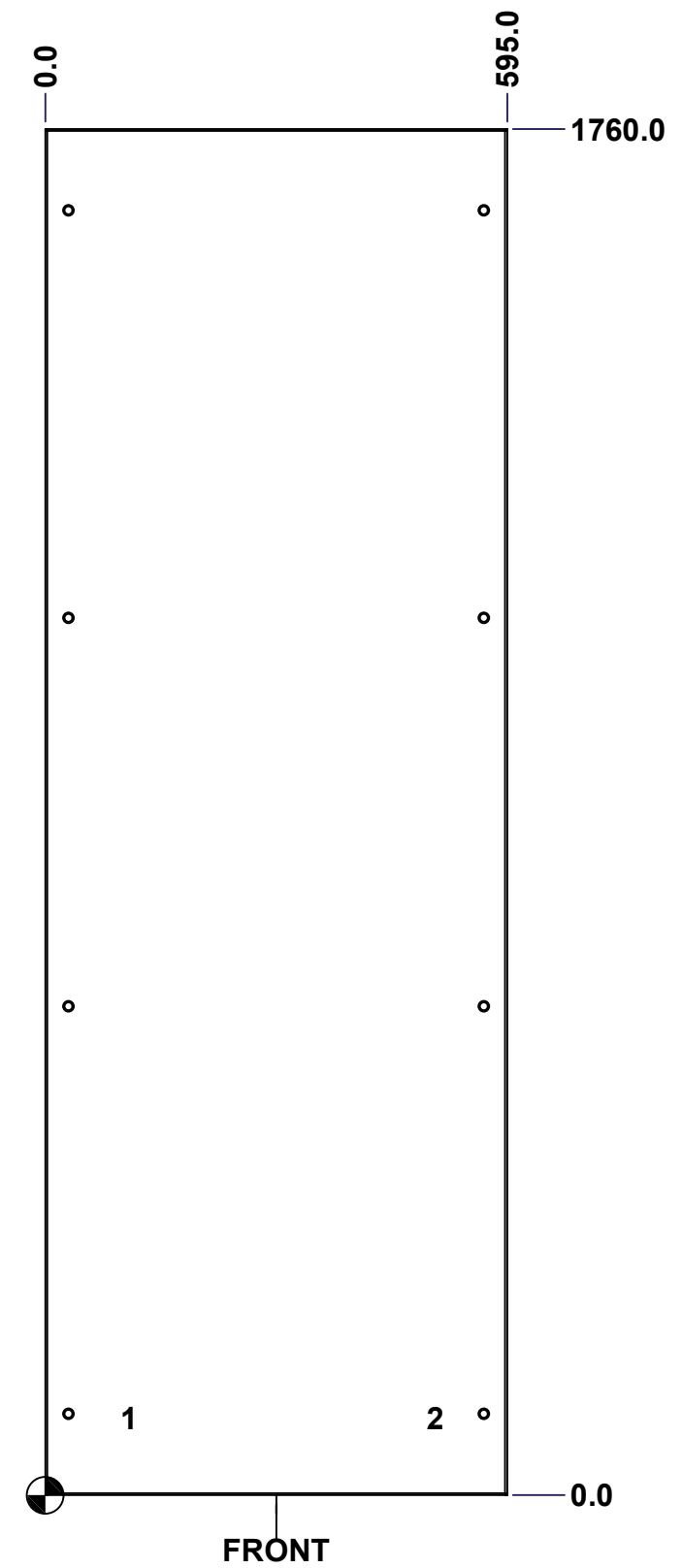

Use bending program path 6500 MX > 6500 MXR

	Description	Status
	6500 MXR 1800mm x 600mm Back	(NULL)
	Part Number Numéro Pièce	Rev.
	6500MXU180608B	0
		12
		18

This drawing is confidential and must not be reproduced or used without the consent of EXM

Ce dessin est confidentiel et ne doit pas être reproduit ou utilisé sans le consentement de EXM

No.	Revisions	Date	By/Par

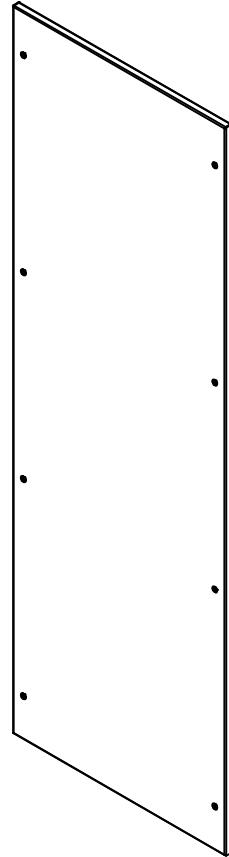

Isometric View

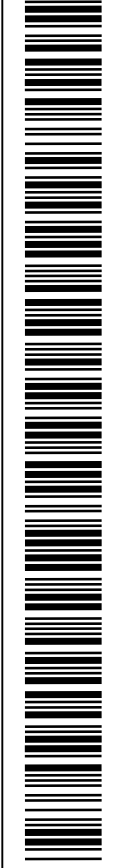

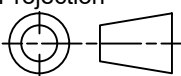
		Flatness Aplatissement Max 3.0mm	
Tél: (450) 979-4373 Fax: (450) 979-4626 www.exmweb.com		Projection 	
Customer Client		Date	
Drawn By / Dessiné Par: BoxCad: BoxCad		Date: 05-Mar-15	
Material / Matière: 14 Ga Cold Rolled A1008 CS Type B			
Color / Couleur: Light Grey RAL7035		Finish / Fini: Textured	
Description: 6500 MXR 1800mm x 600mm Back			Detail Rev.
Part Number / Numéro Pièce: 6500MXU180608B		Rev.:	13
			18

Qty	Part Number	Rev	Description
1	STK-P-03820R	0	Powder Paint (Light Grey / Rough Textured)
1	6500MXU180608BG	0	6500 MXR 1800mm x 600mm Back Gasket
8	STK-Q-03071	0	M6 x 16mm Machine Screw
2	STK-Q-16080	0	Ground Stud M6 x 16mm Steel
1	6500MXU180608B-P	0	6500 MXR 1800mm x 600mm Back Part
Parts List			

This drawing is confidential and must not be reproduced or used without the consent of EXM

Ce dessin est confidentiel et ne doit pas être reproduit ou utilisé sans le consentement de EXM

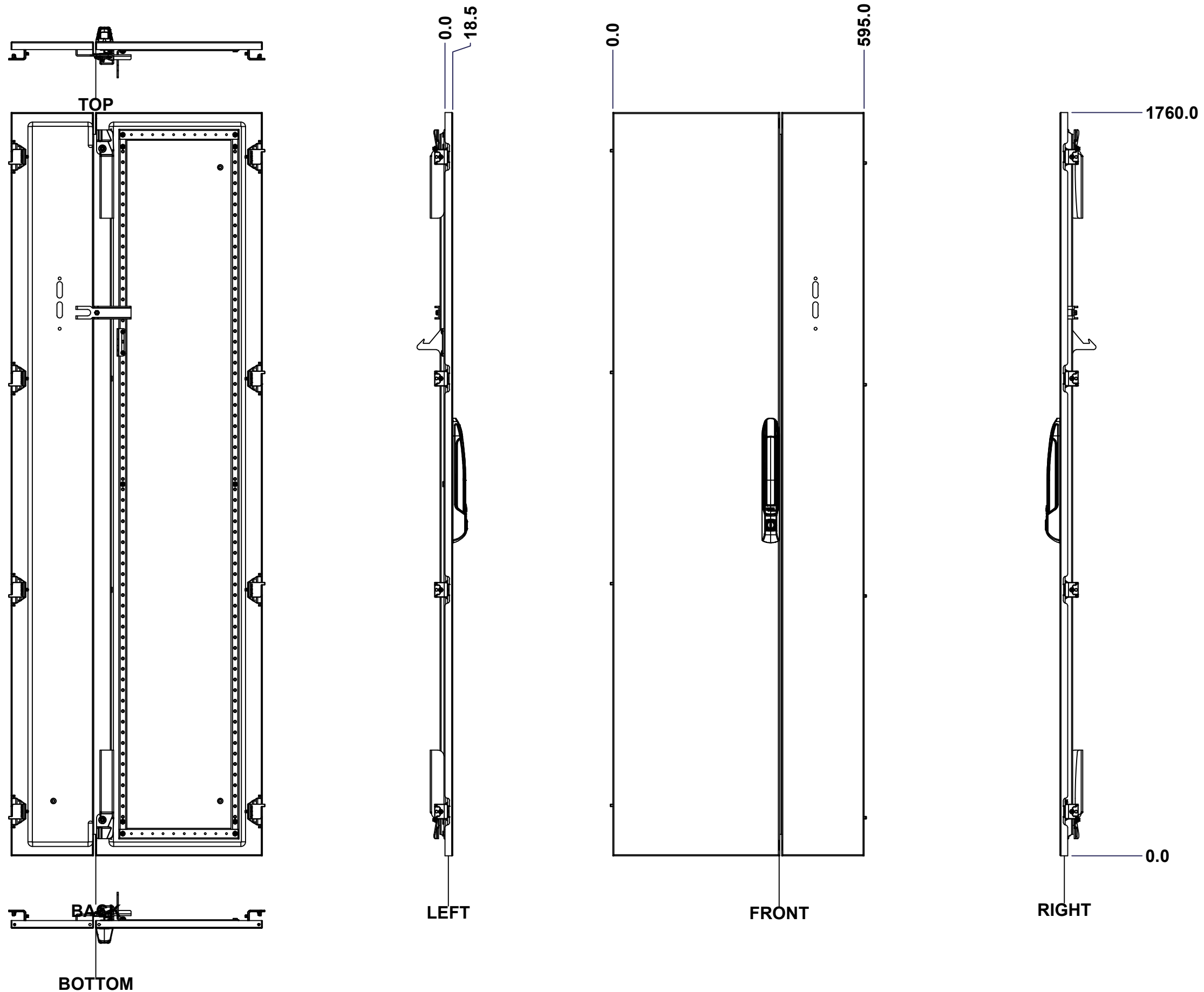

No.	Revisions	Date	By/Par

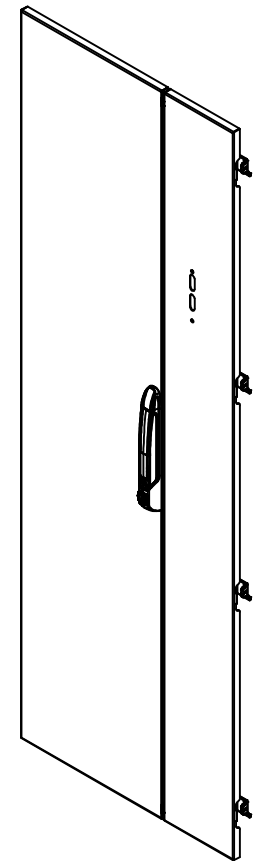

Isometric View

EXM
exm

Tél: (450) 979-4373
Fax: (450) 979-4626
www.exmweb.com

Flatness
Aplatissement
Max 3.0mm

Projection

Customer Client	Date
Drawn By Dessiné Par BoxCad: BoxCad	Date 05-Mar-15
Material Matière 14 Ga Cold Rolled A1008 CS Type B	
Color Couleur Light Grey RAL7035	Finish Fini Textured

Description	Detail Rev.
6500 MXDU 1800mm x 600mm Front	

Part Number Numéro Pièce	Rev.	14
6500MXU180608F	0	18

Use gasket program path 6500 MX > 6500 MXDU

SEE BILL OF MATERIAL ON LAST PAGE

This drawing is confidential and must not be reproduced or used without the consent of EXM

Ce dessin est confidentiel et ne doit pas être reproduit ou utilisé sans le consentement de EXM

STANDARD FEATURES ARE NOT LISTED IN THIS HOLE TABLE

HOLE TABLE - FRONT VIEW (CUSTOM FEATURE ONLY)

CUT-OUT	XDIM	YDIM	DESCRIPTION
1	100.0	130.0	GND STUD M6 x 16mm (Inside)
2	100.0	1630.0	GND STUD M6 x 16mm (Inside)
3	495.0	130.0	GND STUD M6 x 16mm (Inside)
4	64.5	52.8	STIFF. STUD M6 x 18mm (Inside)
5	64.5	880.0	STIFF. STUD M6 x 18mm (Inside)
6	64.5	1707.2	STIFF. STUD M6 x 18mm (Inside)
7	64.5	1679.0	STIFF. STUD M6 x 18mm (Inside)
8	64.5	81.0	STIFF. STUD M6 x 18mm (Inside)
9	330.5	52.8	STIFF. STUD M6 x 18mm (Inside)
10	330.5	880.0	STIFF. STUD M6 x 18mm (Inside)
11	330.5	1707.2	STIFF. STUD M6 x 18mm (Inside)
12	330.5	1679.0	STIFF. STUD M6 x 18mm (Inside)
13	330.5	81.0	STIFF. STUD M6 x 18mm (Inside)
14	374.0	170.0	LARGE CBAR GUIDE (Inside)
15	374.0	1590.0	LARGE CBAR GUIDE (Inside)
16	374.0	680.0	LARGE CBAR GUIDE (Inside)
17	374.0	1080.0	LARGE CBAR GUIDE (Inside)

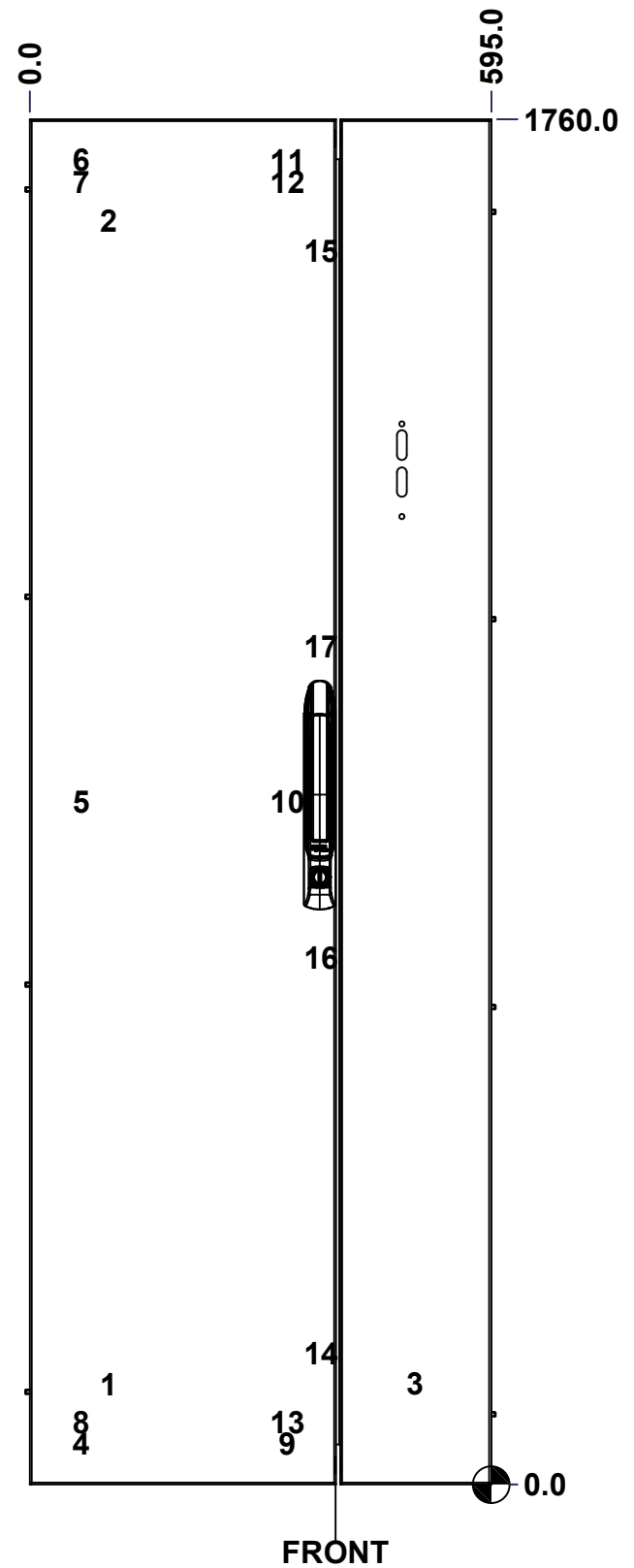

Use bending program path 6500 MX > 6500 MXDU

	Description 6500 MXDU 1800mm x 600mm Front	Status (NULL)
	Part Number Numéro Pièce 6500MXU180608F	Rev. 0

This drawing is confidential and must not be reproduced or used without the consent of EXM

Ce dessin est confidentiel et ne doit pas être reproduit ou utilisé sans le consentement de EXM

No.	Revisions	Date	By/Par

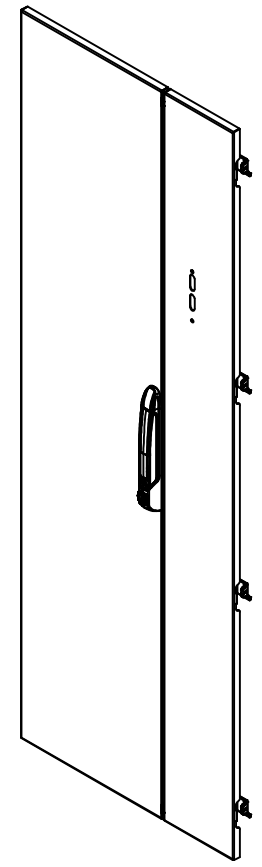

Isometric View



1	STK-P-03820R	0	Powder Paint (Light Grey / Rough Textured)
1	STK-A-51160	0	886PH2-SL - Pull Handle Lock - Assembly
1	STK-Q-45758	1	886 PH2 Pull Handle Bridge Part
4	STK-Q-16410	0	Guide Stud - Large (No Paint Cap Required)
4	STK-A-70586	3	Fixed Double Door Bracket Assembly
1	STK-Q-45652-18	1	6500 MX - Lower Closing Bar 1800mm
1	STK-Q-45651-18	1	6500 MX - Upper Closing Bar 1800mm
1	STK-Q-46650	3	6500 MXDU Disconnect Hook
8	STK-K-06810	7	6500 MX Hinge Assy
2	STK-Q-05020	5	M5 x 8mm Thread Rolling Screw
1	STK-Q-07220	0	M6 Nylon Insert Lock Nut
1	STK-Q-46750	4	6500 MXDU Disconnect Defeater
1	STK-K-10102	3	6500MX - Lock Handle Kit for Flange Door - Right
1	STK-K-10101	3	6500MX - Lock Handle Kit for Flange Door - Left
1	STK-Q-16030	0	Stud M6 x 10mm
2	STK-Q-16050	0	Stud M6 x 18mm
1	6500MXU180608F1G	0	6500 MXDU 1800mm x 600mm Front Gasket
1	6500MXU180608F1-P	0	6500 MXDU 1800mm x 600mm Front Part
10	STK-Q-16055	1	M6 x 18mm Stud (No Paint Cap Required)
3	STK-Q-16080	0.1.1	Ground Stud M6 x 16mm Steel
1	6500MXU180608DS1	5	6500 MX 1800mm x 600mm Door Stiffener
1	6500MXU180608FG	0	6500 MXDU 1800mm x 600mm Front Gasket
1	6500MXU180608F-P	0	6500 MXDU 1800mm x 600mm Front Part

Qty	Part Number	Rev.	Description
Parts List			

	Tél: (450) 979-4373 Fax: (450) 979-4626 www.exmweb.com	Flatness Aplatissement Max 3.0mm
	Projection	
Customer Client	Date	
Drawn By Dessiné Par: BoxCad: BoxCad	Date	05-Mar-15
Material Matière	14 Ga Cold Rolled A1008 CS Type B	
Color Couleur: Light Grey RAL7035	Finish Fini: Textured	
Description	6500 MXDU 1800mm x 600mm Front	
Part Number Numéro Pièce: 6500MXU180608F	Rev. 0	16 / 18

This drawing is confidential and must not be reproduced or used without the consent of EXM

Ce dessin est confidentiel et ne doit pas être reproduit ou utilisé sans le consentement de EXM

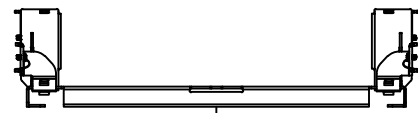

TOP

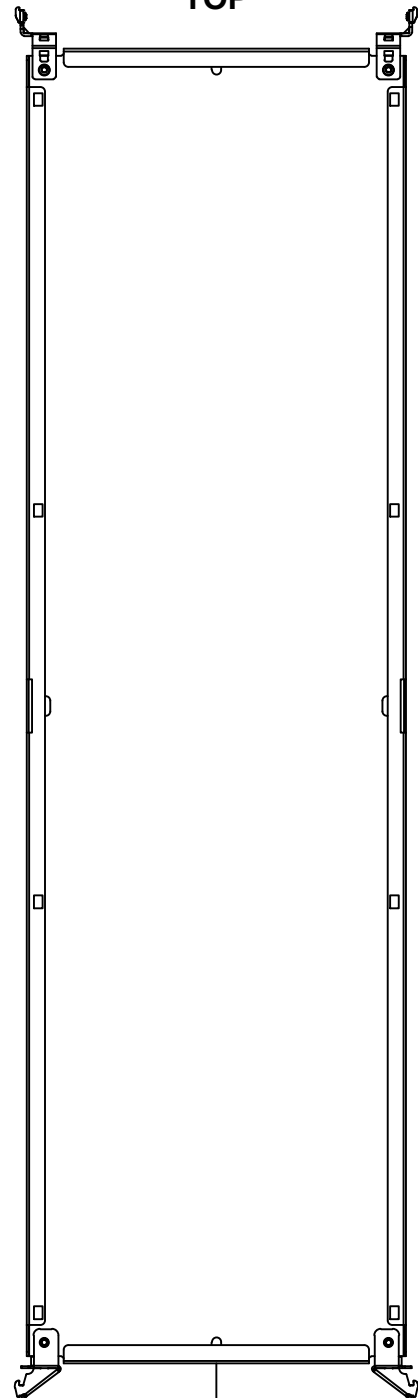

BACK



BOTTOM

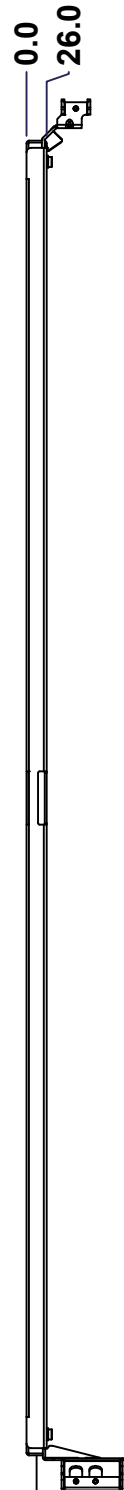

LEFT

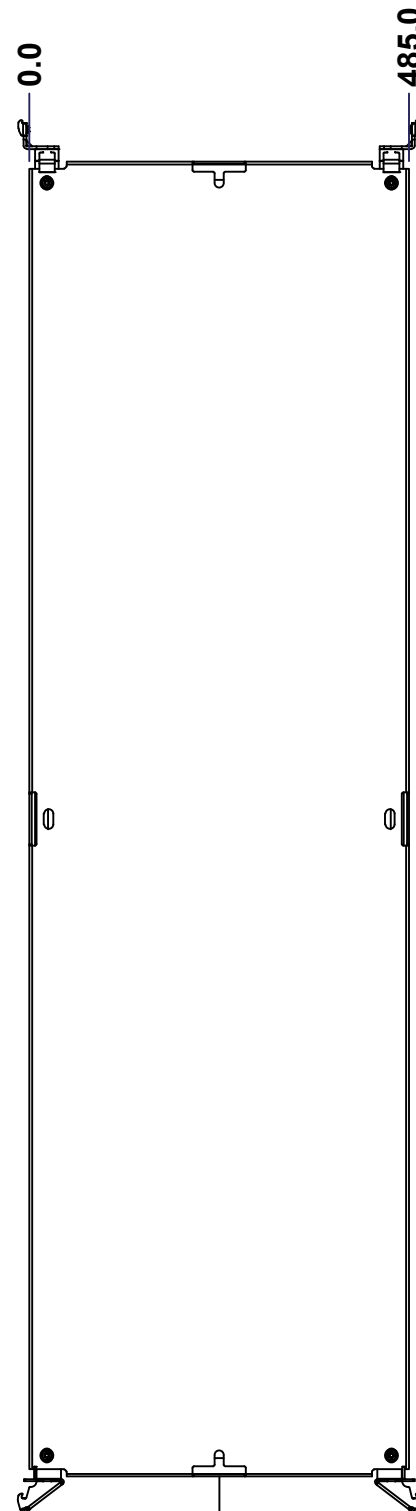

FRONT

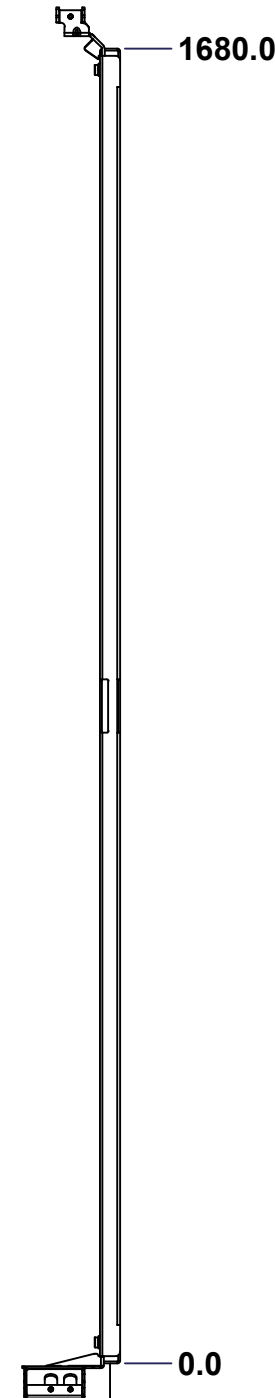

RIGHT

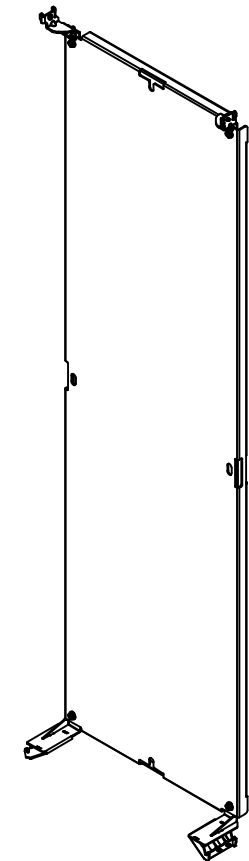

Isometric View

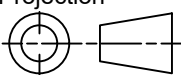

No.	Revisions	Date	By/Par

 Tél: (450) 979-4373 Fax: (450) 979-4626 www.exmweb.com		Flatness Aplatissement Max 3.0mm Projection 
Customer Client	Date	
Drawn By Dessiné Par	BoxCad: BoxCad	Date 05-Mar-15
Material Matière	12 Ga Galvanized (2.5mm)	
Color Couleur	Unpainted	Finish Fini Unpainted
Description	Detail Rev.	
6500 MXM 1800mm x 600mm Back Inner Panel		
Part Number Numéro Pièce	Rev.	
6500MXU180608BIP	0	17 18

SEE BILL OF MATERIAL ON LAST PAGE

This drawing is confidential and must not be reproduced or used without the consent of EXM

Ce dessin est confidentiel et ne doit pas être reproduit ou utilisé sans le consentement de EXM

No.	Revisions	Date	By/Par

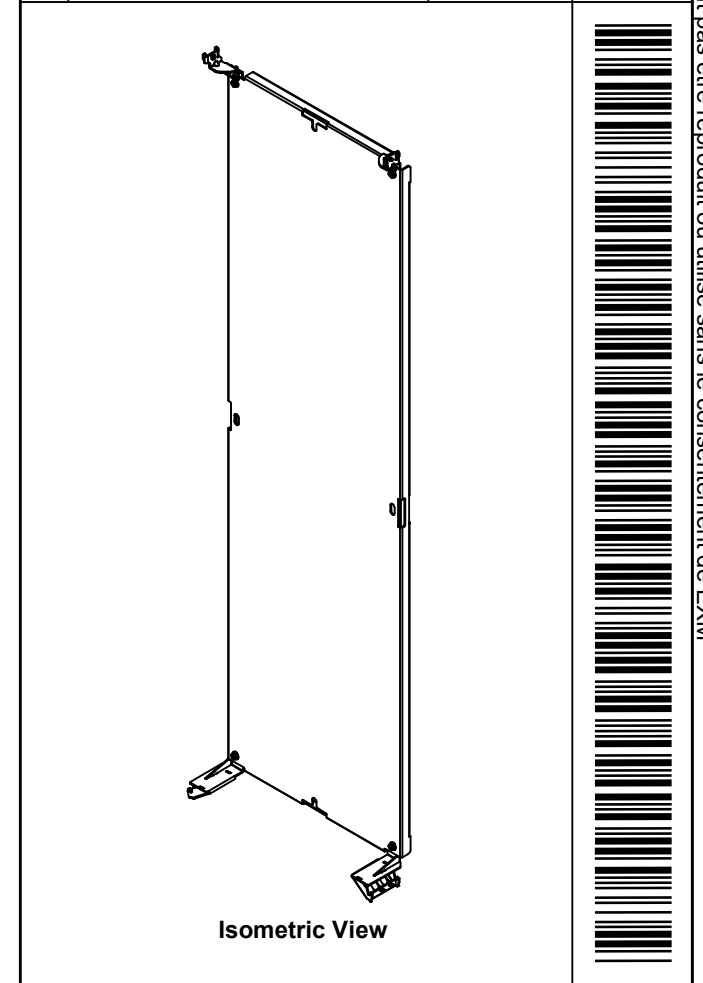

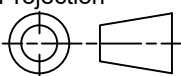
 Tél: (450) 979-4373 Fax: (450) 979-4626 www.exmweb.com		Flatness Aplatissement Max 3.0mm Projection 
Customer Client	Date	
Drawn By Dessiné Par	BoxCad: BoxCad	Date 05-Mar-15
Material Matière	12 Ga Galvanized (2.5mm)	
Color Couleur	Unpainted	Finish Fini Unpainted
Description 6500 MXM 1800mm x 600mm Back Inner Panel		Detail Rev.
Part Number Numéro Pièce	Rev. 0	18
6500MXU180608BIP		18

Qty	Part Number	Rev	Description
1	STK-A-49005	5	6500 MXM - Bottom Inner Panel Support Assembly (Right)
1	STK-A-49000	5	6500 MXM - Bottom Inner Panel Support Assembly (Left)
1	STK-A-49015	0	6500MXM - Top Inner Panel Support Kit (Right)
1	STK-A-49010	0	6500MXM - Top Inner Panel Support Kit (Left)
1	6500MXU180608BIP-P	0	6500 MXM 1800mm x 600mm Back Inner Panel Part
Parts List			