

This drawing is confidential and must not be reproduced or used without the consent of EXM

Ce dessin est confidentiel et ne doit pas être reproduit ou utilisé sans le consentement de EXM

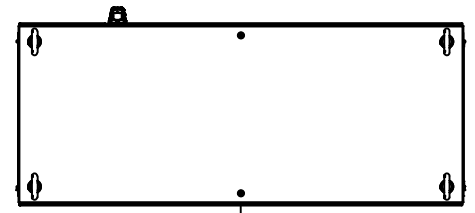

TOP

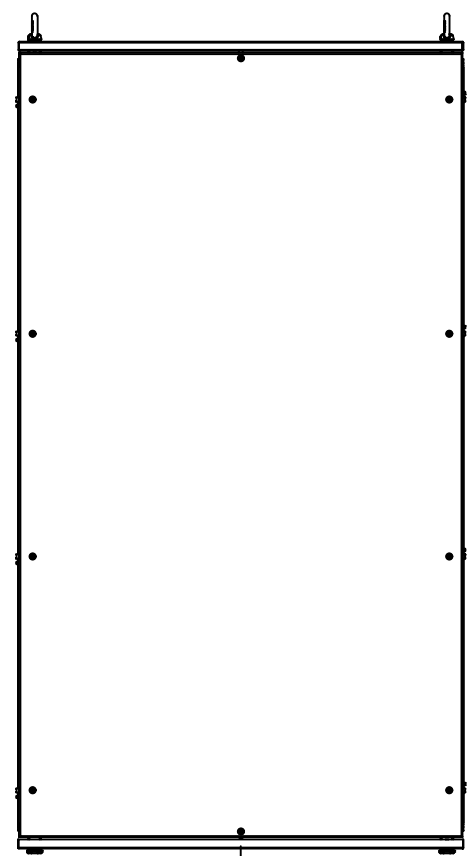

BACK

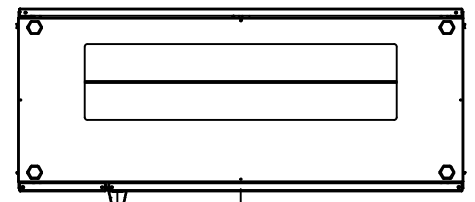

BOTTOM

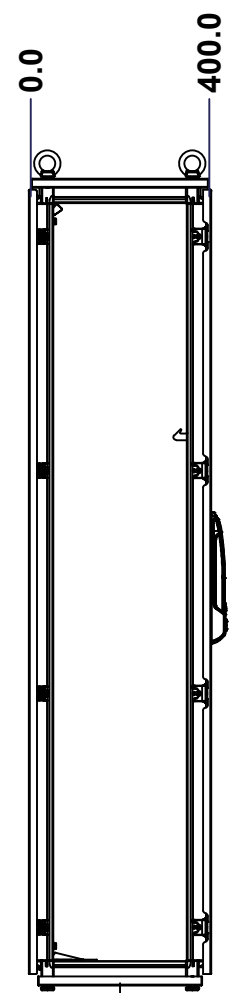

LEFT

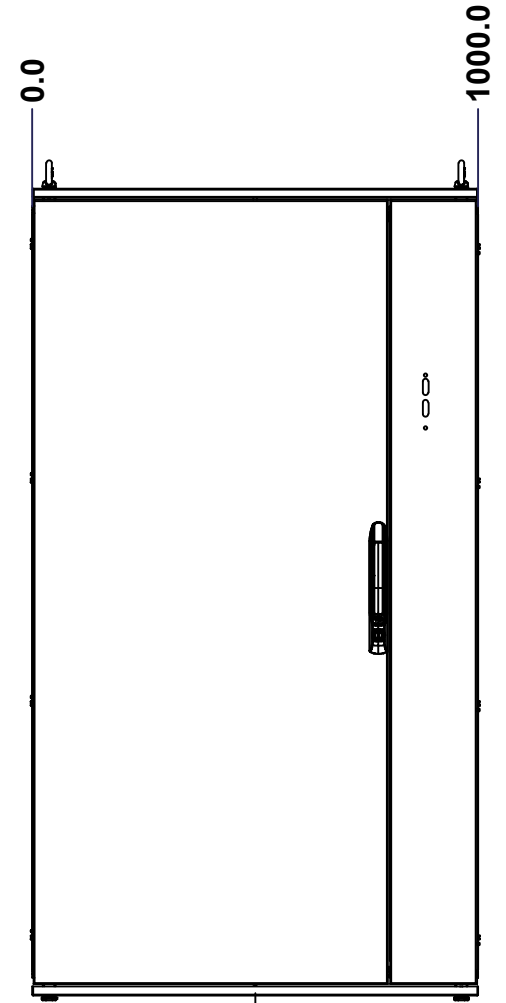

FRONT

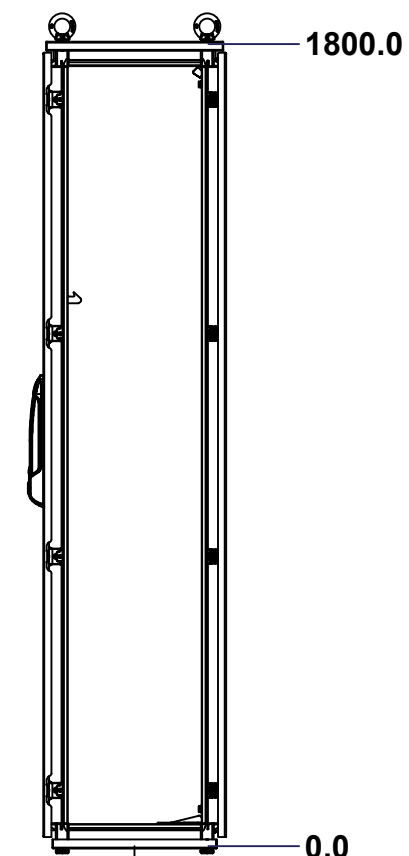

RIGHT

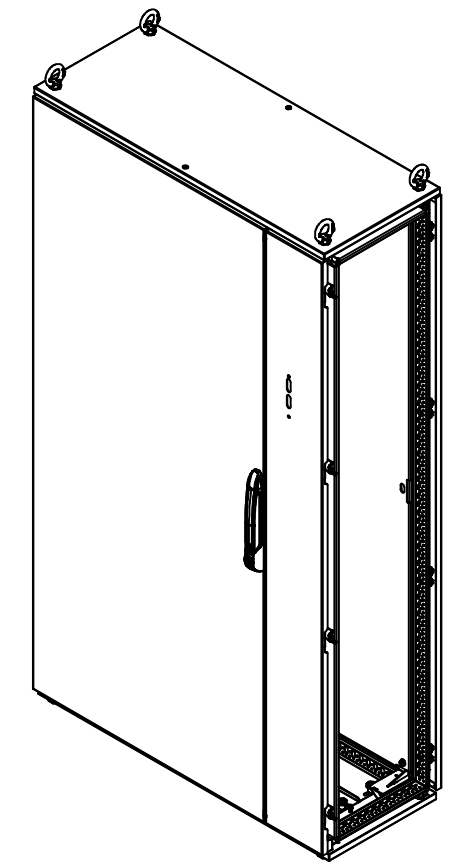

Isometric View



No.	Revisions	Date	By/Par



Tél: (450) 979-4373
 Fax: (450) 979-4626
www.exmweb.com

Flatness
 Aplatissement
 Max 3.0mm
 Projection

Customer Client
 Drawn By Dessiné Par BoxCad: BoxCad
 Date 09-Mar-15

Material Matière See Part List

Color Couleur See Part List
 Finish Fini See Part List

Description 6500MX 1800mm x 1000mm x 400mm Assembly
 Detail Rev.

Part Number Numéro Pièce **6500MXU181004**
 Rev. 1
0

SEE BILL OF MATERIAL ON LAST PAGE

This drawing is confidential and must not be reproduced or used without the consent of EXM

Ce dessin est confidentiel et ne doit pas être reproduit ou utilisé sans le consentement de EXM

No.	Revisions	Date	By/Par

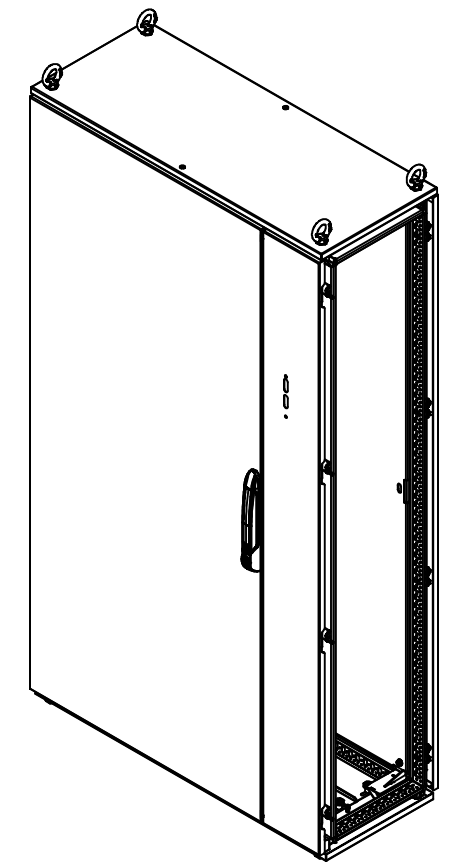

Isometric View



Tél: (450) 979-4373
 Fax: (450) 979-4626
www.exmweb.com

Flatness
Aplatissement
Max 3.0mm
Projection

Customer Client	Date
Drawn By / Dessiné Par: BoxCad: BoxCad	Date: 09-Mar-15
Material / Matière	See Part List

Color / Couleur	See Part List	Finish / Fini	See Part List
Description		Detail Rev.	
6500MX 1800mm x 1000mm x 400mm Assembly			

Part Number / Numéro Pièce	Rev.	2
6500MXU181004	0	18

Qty	Part Number	Rev	Description
1	6500MXU181004BIP	0	6500 MXM 1800mm x 1000mm Back Inner Panel
1	6500MXU181004F	0	6500 MXDU 1800mm x 1000mm Front
1	6500MXU181004B	0	6500 MXR 1800mm x 1000mm Back
1	6500MXU181004BT	0	6500 MXB 1000mm x 400mm Bottom
1	6500MXU181004T	0	6500 MXT 1000mm x 400mm Top
1	6500MXU181004FR	0	6500 MX 1800mm x 1000mm x 400mm Frame
Parts List			

This drawing is confidential and must not be reproduced or used without the consent of EXM

Ce dessin est confidentiel et ne doit pas être reproduit ou utilisé sans le consentement de EXM

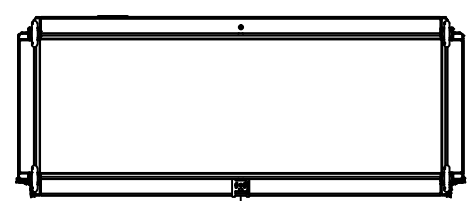

TOP

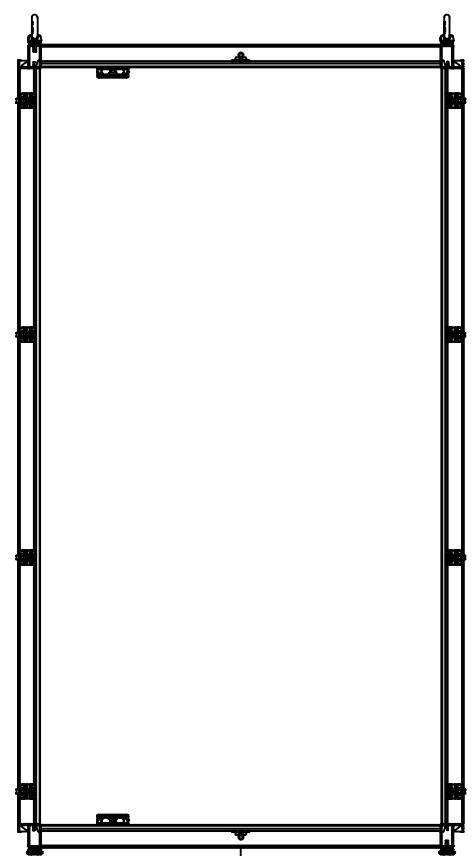

BACK

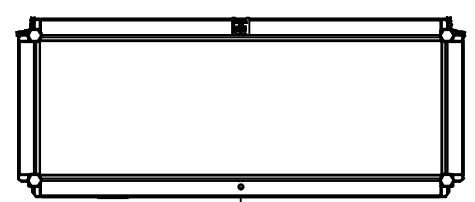

BOTTOM

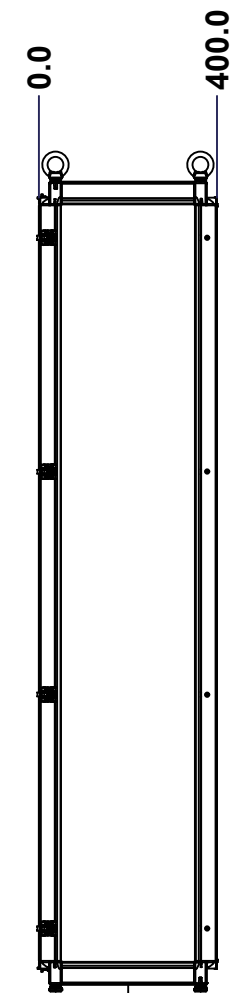

LEFT

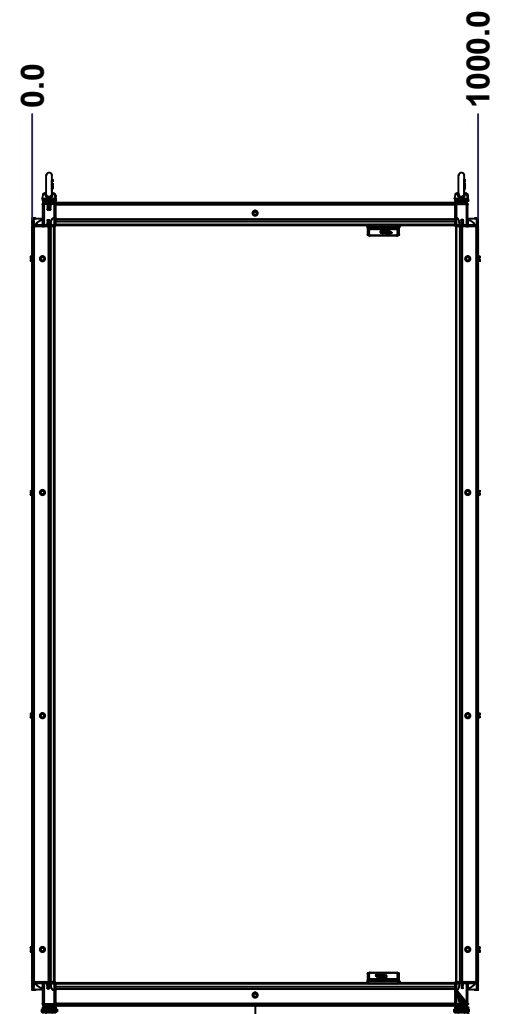

FRONT

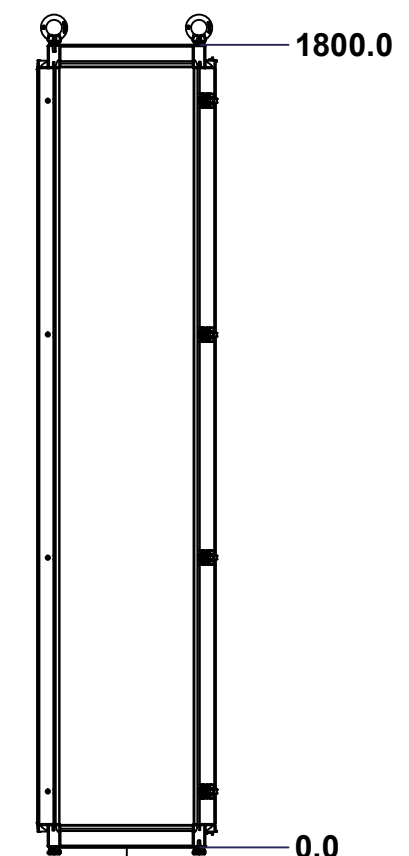

RIGHT

Grind excess weld off corner(s)

No.	Revisions	Date	By/Par

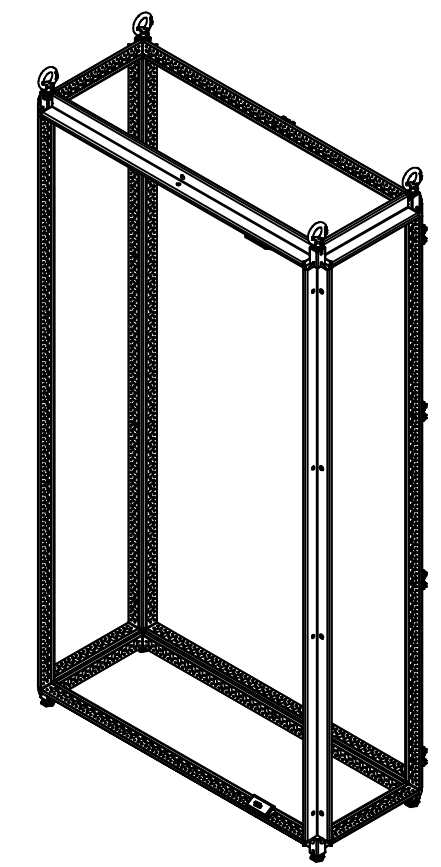

Isometric View

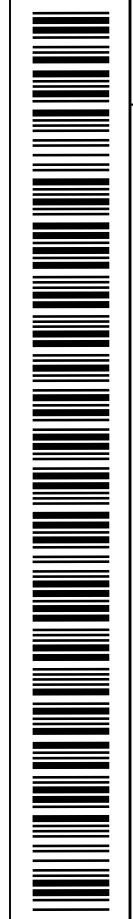

Tél: (450) 979-4373
 Fax: (450) 979-4626
www.exmweb.com

Flatness
Aplatissement
Max 3.0mm
Projection

Customer Client	Date
Drawn By / Dessiné Par: BoxCad: BoxCad	Date: 09-Mar-15
Material / Matière: 16 Ga Electro-Galvanized (1.4mm)	
Color / Couleur: Iron Grey RAL7011	Finish / Fini: Textured

Description: 6500 MX 1800mm x 1000mm x 400mm Frame	Detail Rev.
Part Number / Numéro Pièce: 6500MXU181004FR	Rev. 3

SEE BILL OF MATERIAL ON LAST PAGE

Rev. 0

This drawing is confidential and must not be reproduced or used without the consent of EXM

Ce dessin est confidentiel et ne doit pas être reproduit ou utilisé sans le consentement de EXM

No.	Revisions	Date	By/Par

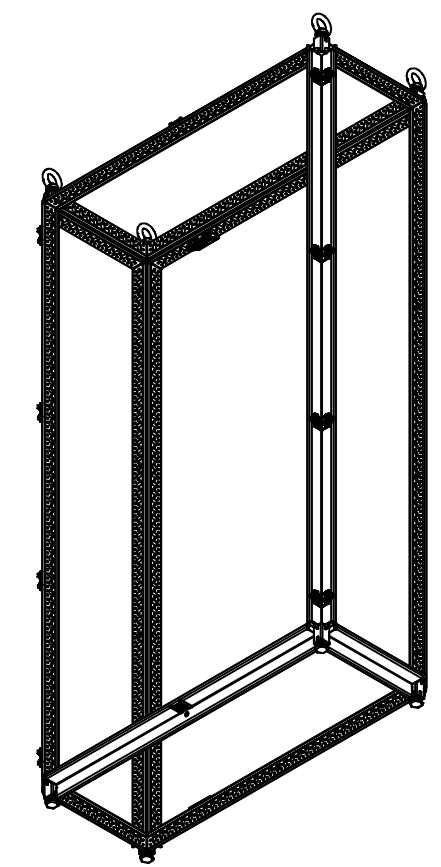

Isometric View



1	STK-P-03810ST	0	Powder Paint (Iron Grey /Sand Textured)
1	STK-Q-04000	4	M6.0 x 9.5mm Truss Head Tapping Screw
2	STK-Q-70486	0	6500 MX Single Rear Panel Bracket
4	STK-Q-47250-10	6	6500 MX 1000mm Horizontal Frame Post Part
4	STK-Q-47250-04	6	6500 MX 400mm Horizontal Frame Post Part
2	STK-Q-05020	5	M5 x 8mm Thread Rolling Screw
2	STK-A-74730	2	6500 MX - Flange Door Sealing Block
21	STK-Q-77120	1	6500MX-Frame Rubber Plug
8	STK-A-70580	9	Mtrx Bracket
8	STK-Q-00610	3	M16 x 30.0mm Bolt
8	STK-A-49448	6	6500 MX - Frame Sheet Metal Corner Assembly
4	STK-Q-49500	3	M12 Eye Bolt (0.34T)
4	STK-Q-61110	0	M12 Feet Leveler
4	STK-Q-47251-18	6	6500 MX 1800mm Vertical Frame Post Part
Qty	Part Number	Rev	Description
Parts List			

	Tél: (450) 979-4373 Fax: (450) 979-4626 www.exmweb.com	Flatness Aplatissement Max 3.0mm
		Projection
Customer Client		Date
Drawn By Dessiné Par	BoxCad: BoxCad	Date 09-Mar-15
Material Matière	16 Ga Electro-Galvanized (1.4mm)	
Color Couleur	Iron Grey RAL7011	Finish Fini Textured
Description	6500 MX 1800mm x 1000mm x 400mm Frame	
Part Number Numéro Pièce	6500MXU181004FR	Detail Rev.
		Rev. 4
		0
		18

This drawing is confidential and must not be reproduced or used without the consent of EXM

Ce dessin est confidentiel et ne doit pas être reproduit ou utilisé sans le consentement de EXM

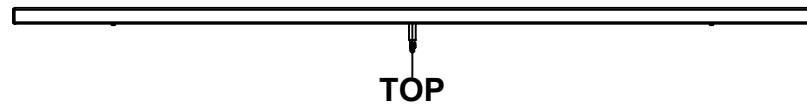

TOP

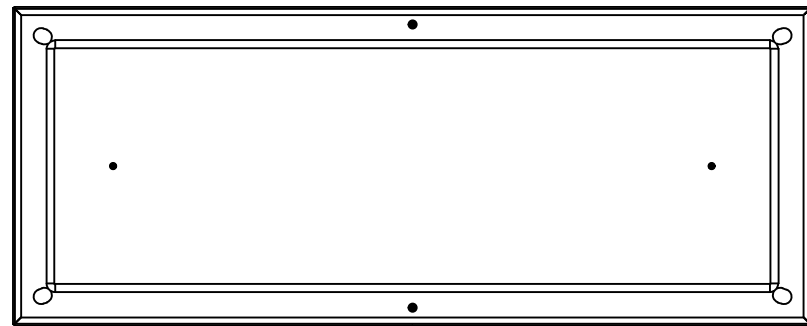

BACK

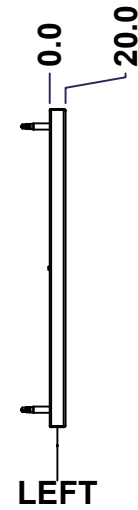

LEFT

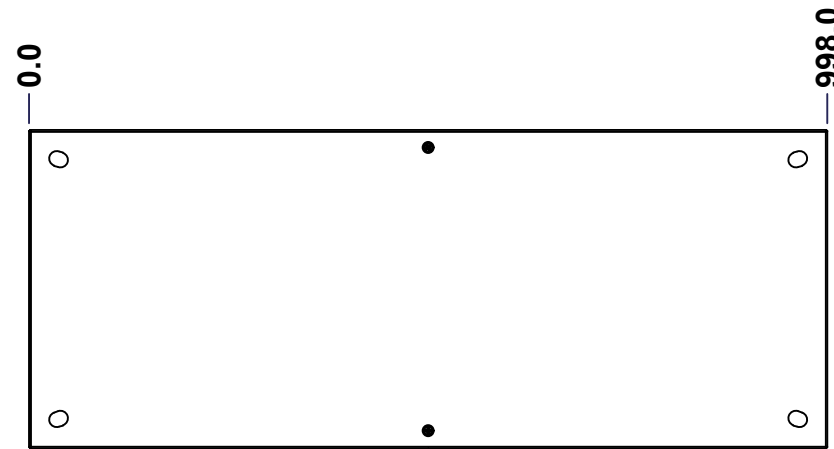

FRONT

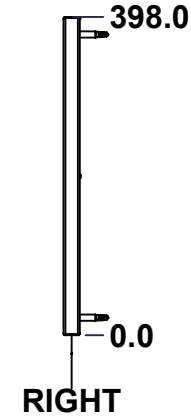

RIGHT



BOTTOM

No.	Revisions	Date	By/Par

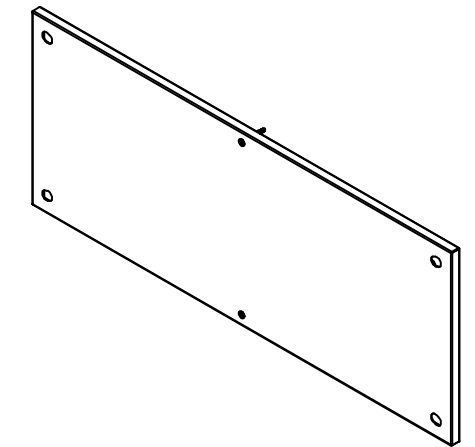

Isometric View



Tél: (450) 979-4373
 Fax: (450) 979-4626
www.exmweb.com

Flatness
Aplatissement

Max 3.0mm

Projection

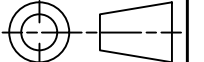

Customer Client	Date
Drawn By / Dessiné Par: BoxCad: BoxCad	Date: 09-Mar-15
Material / Matière: 16 Ga Cold Rolled A1008 CS Type B	

Color / Couleur: Iron Grey RAL7011	Finish / Fini: Textured
------------------------------------	-------------------------

Description: 6500 MXT 1000mm x 400mm Top	Detail Rev.
--	-------------

Part Number / Numéro Pièce: 6500MXU181004T	Rev. 0	5	18
--	--------	---	----

Use gasket program path 6500 MX > 6500 MXT

SEE BILL OF MATERIAL ON LAST PAGE

This drawing is confidential and must not be reproduced or used without the consent of EXM

Ce dessin est confidentiel et ne doit pas être reproduit ou utilisé sans le consentement de EXM

STANDARD FEATURES ARE NOT LISTED IN THIS HOLE TABLE			
HOLE TABLE - FRONT VIEW (CUSTOM FEATURE ONLY)			
CUT-OUT	XDIM	YDIM	DESCRIPTION
1	125.0	199.0	GND STUD M6 x 18mm (Inside)
2	873.0	199.0	GND STUD M6 x 18mm (Inside)

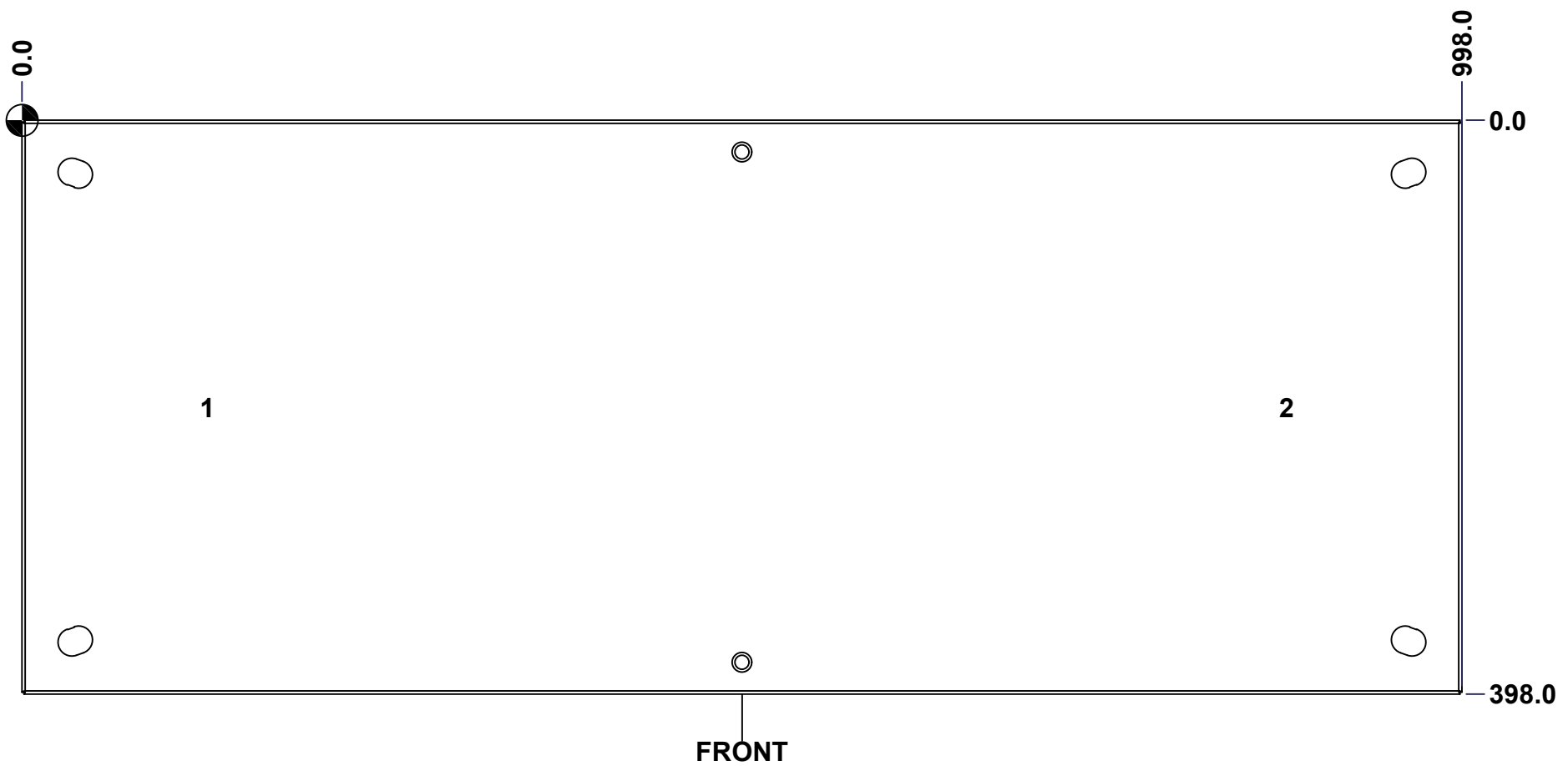

Use bending program path 6500 MX > 6500 MXT

	Description	Status
	6500 MXT 1000mm x 400mm Top	(NULL)
	Part Number Numéro Pièce	Rev.
	6500MXU181004T	0 / 6
		18

This drawing is confidential and must not be reproduced or used without the consent of EXM

Ce dessin est confidentiel et ne doit pas être reproduit ou utilisé sans le consentement de EXM

No.	Revisions	Date	By/Par

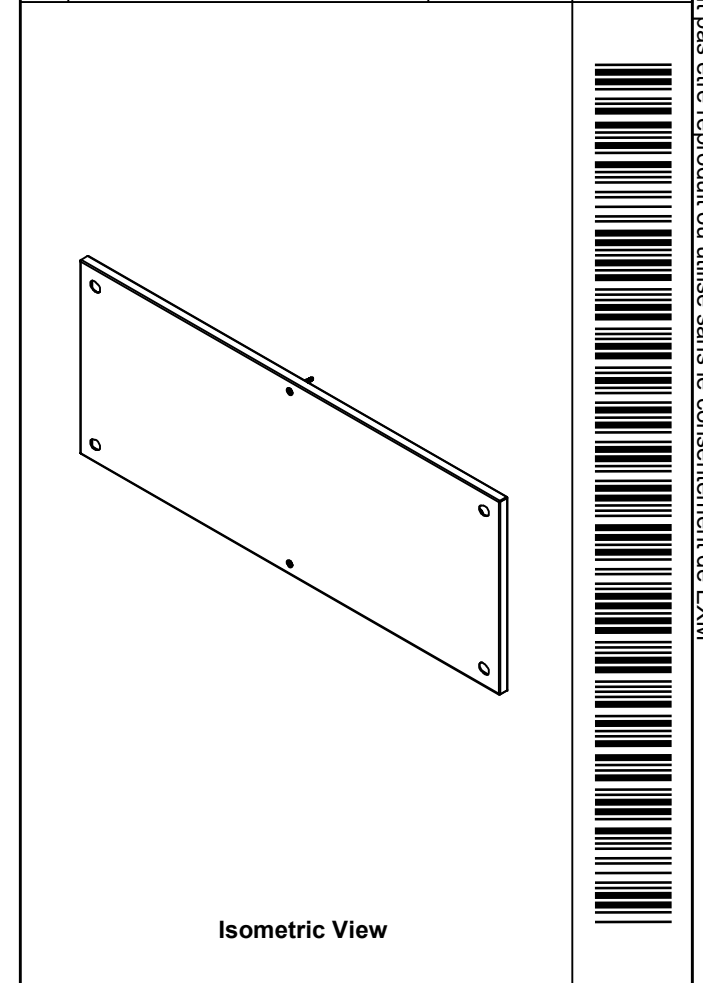

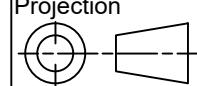
 Tél: (450) 979-4373 Fax: (450) 979-4626 www.exmweb.com		Flatness Aplatissement Max 3.0mm Projection 
Customer Client	Date	
Drawn By Dessiné Par	BoxCad: BoxCad	Date 09-Mar-15
Material Matière	16 Ga Cold Rolled A1008 CS Type B	
Color Couleur	Iron Grey RAL7011	Finish Fini Textured
Description	Detail Rev.	
6500 MXT 1000mm x 400mm Top		
Part Number Numéro Pièce	Rev.	7
6500MXU181004T	0	18

Qty	Part Number	Rev	Description
1	STK-P-03810ST	0	Powder Paint (Iron Grey /Sand Textured)
2	STK-Q-16055	1	M6 x 18mm Stud (No Paint Cap Required)
2	STK-Q-90227	1	Flat Head Drilling Screw M6.3 x 56.0mm Long
1	6500MXU181004TG	0	6500 MXT 1000mm x 400mm Top Gasket
1	6500MXU181004T-P	0	6500 MXT 1000mm x 400mm Top Part
Parts List			

This drawing is confidential and must not be reproduced or used without the consent of EXM

Ce dessin est confidentiel et ne doit pas être reproduit ou utilisé sans le consentement de EXM

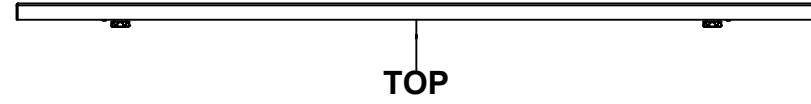

TOP

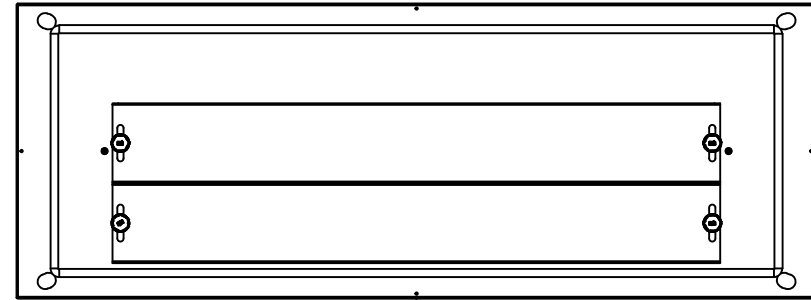

BACK

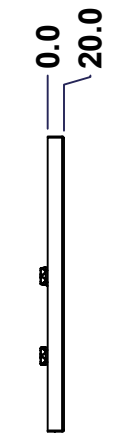

LEFT

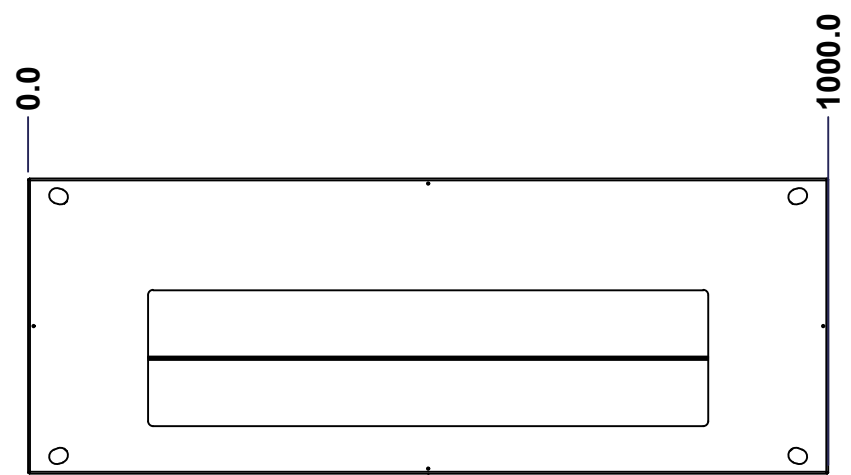

FRONT

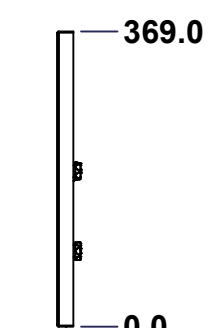

RIGHT

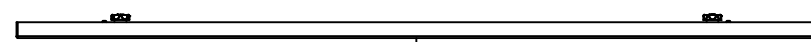

BOTTOM

No.	Revisions	Date	By/Par

Isometric View

<p>Tél: (450) 979-4373 Fax: (450) 979-4626 www.exmweb.com</p>		Flatness Aplatissement	
		Max 3.0mm	
Customer Client		Date	
Drawn By Dessiné Par		Date	
Material Matière		Projection	
Color Couleur		Finish Fini	
Description		Detail Rev.	
Part Number Numéro Pièce		Rev.	

Use gasket program path 6500 MX > 6500MXB

SEE BILL OF MATERIAL ON LAST PAGE

BoxCad: BoxCad 09-Mar-15
 16 Ga Cold Rolled A1008 CS Type B
 Iron Grey RAL7011 Textured
 6500 MXB 1000mm x 400mm Bottom
6500MXU181004BT 8
 0 18

This drawing is confidential and must not be reproduced or used without the consent of EXM

Ce dessin est confidentiel et ne doit pas être reproduit ou utilisé sans le consentement de EXM

STANDARD FEATURES ARE NOT LISTED IN THIS HOLE TABLE

HOLE TABLE - FRONT VIEW (CUSTOM FEATURE ONLY)

CUT-OUT	XDIM	YDIM	DESCRIPTION
1	110.0	184.5	GND STUD M6 x 18mm (Inside)
2	890.0	184.5	GND STUD M6 x 18mm (Inside)
3	130.0	194.5	GP STUD M6 x 18mm (Inside)
4	870.0	194.5	GP STUD M6 x 18mm (Inside)
5	130.0	94.5	GP STUD M6 x 18mm (Inside)
6	870.0	94.5	GP STUD M6 x 18mm (Inside)

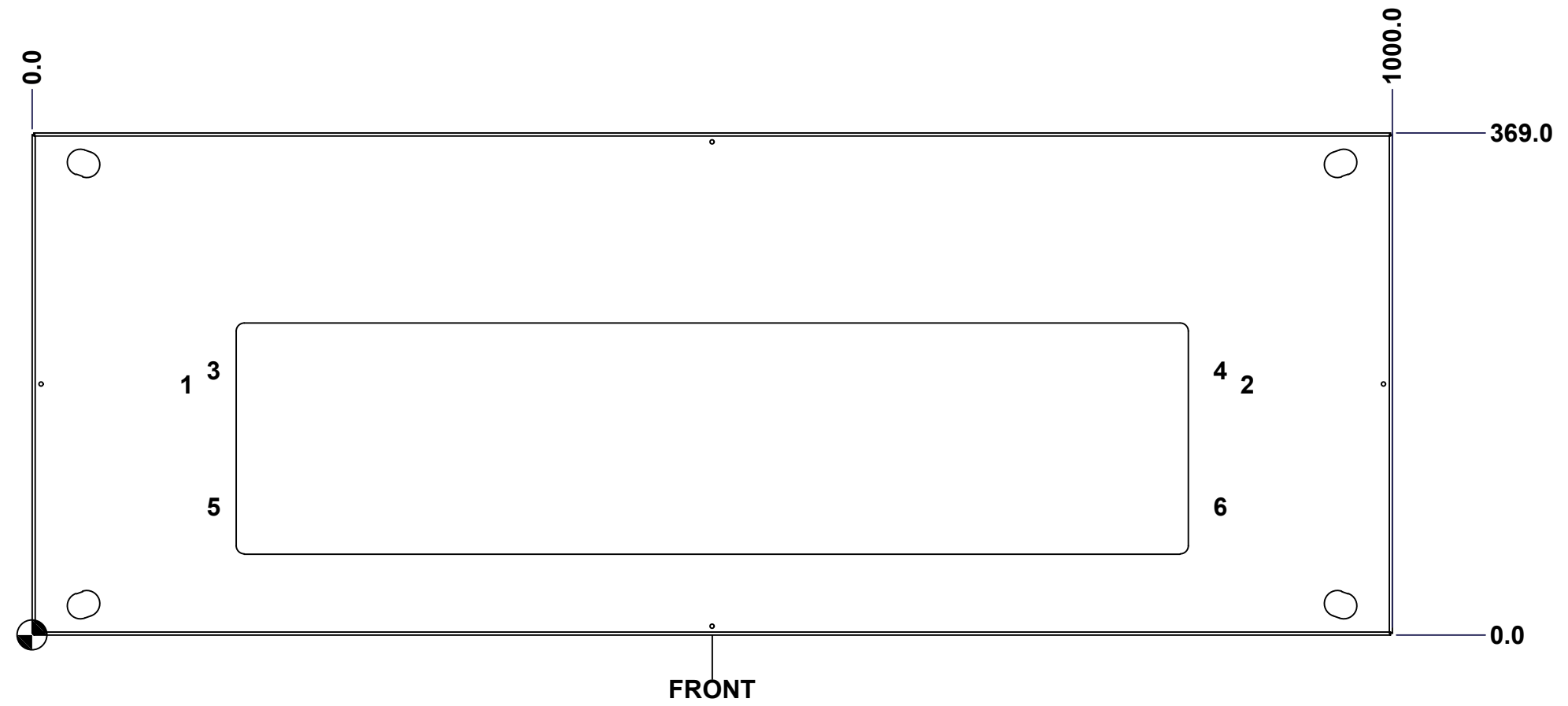

FRONT

Use bending program path 6500 MX > 6500MXB

	Description	Status
	6500 MXB 1000mm x 400mm Bottom	(NULL)
	Part Number Numéro Pièce	Rev.
	6500MXU181004BT	0 / 9
		18

This drawing is confidential and must not be reproduced or used without the consent of EXM

Ce dessin est confidentiel et ne doit pas être reproduit ou utilisé sans le consentement de EXM

No.	Revisions	Date	By/Par

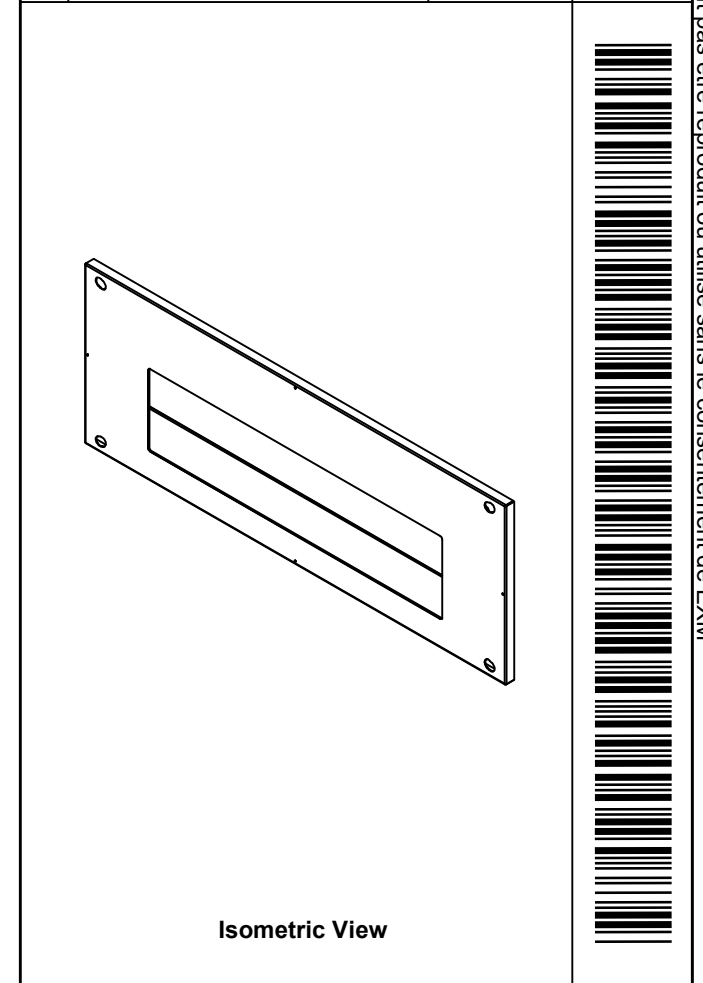

Tél: (450) 979-4373 Fax: (450) 979-4626 www.exmweb.com		Flatness Aplatissement	
		Max 3.0mm	
Customer Client		Date	
Drawn By Dessiné Par		Date	
Material Matière		Projection	
16 Ga Cold Rolled A1008 CS Type B			
Color Couleur		Finish Fini	
Iron Grey RAL7011		Textured	
Description			Detail Rev.
6500 MXB 1000mm x 400mm Bottom			
Part Number Numéro Pièce		Rev.	
6500MXU181004BT		0	10 18

Qty	Part Number	Rev	Description
1	STK-P-03810ST	0	Powder Paint (Iron Grey /Sand Textured)
4	STK-Q-06001	0	Mtrx - Gland Plate M6 Plastic Thumb Nut
6	STK-Q-16055	1	M6 x 18mm Stud (No Paint Cap Required)
2	6500MXU181004GP100-P	0	6500 MXB 1000mm Gland Plate Part (100mm)
1	6500MXU181004BTGPG	0	6500 MXB 1000mm x 400mm Bottom Gland Plate Gasket
1	6500MXU181004BTG	0	6500 MXB 1000mm x 400mm Bottom Gasket
1	6500MXU181004BT-P	0	6500 MXB 1000mm x 400mm Bottom Part
Parts List			

This drawing is confidential and must not be reproduced or used without the consent of EXM

Ce dessin est confidentiel et ne doit pas être reproduit ou utilisé sans le consentement de EXM

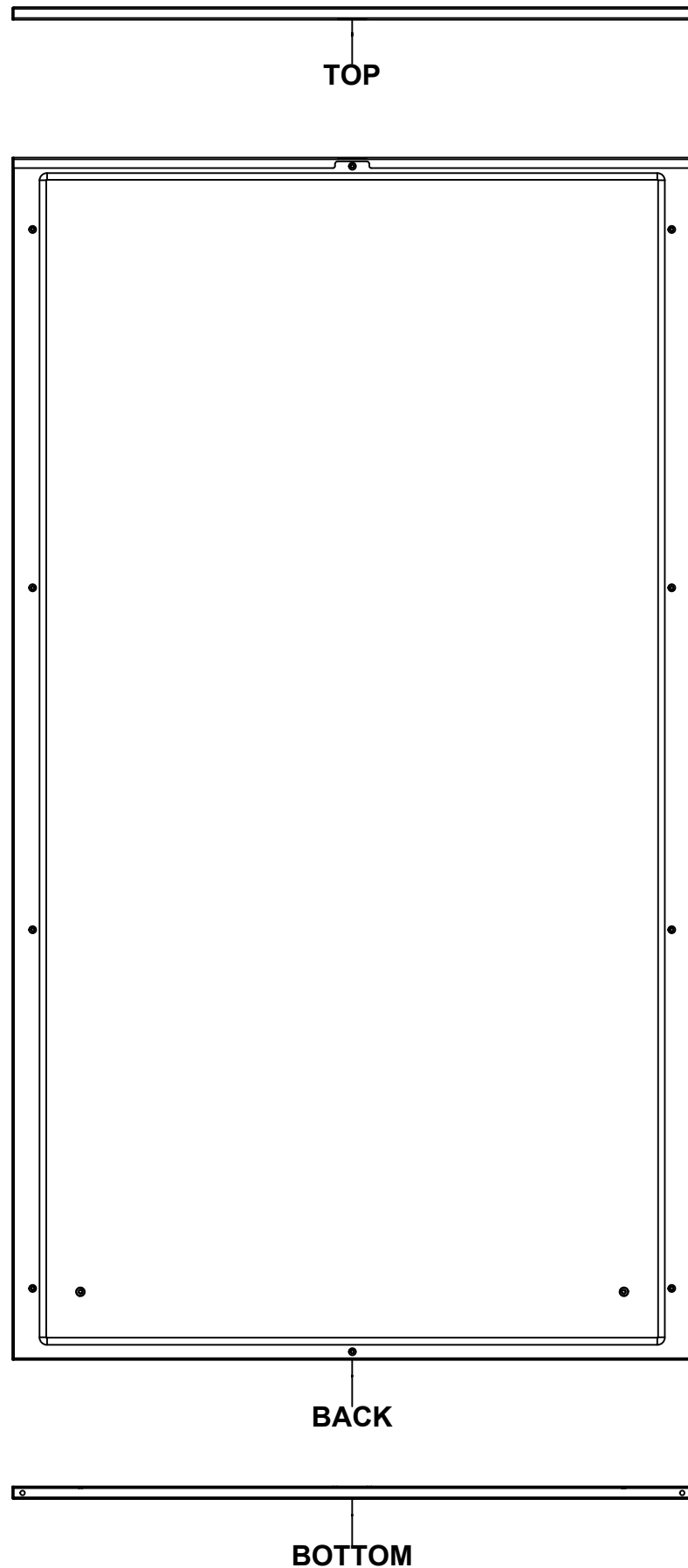

No.	Revisions	Date	By/Par

Isometric View

Tél: (450) 979-4373 Fax: (450) 979-4626 www.exmweb.com		Flatness Aplatissement Max 3.0mm
Projection 		Date
Customer Client	BoxCad: BoxCad	Date 09-Mar-15
Material Matière	14 Ga Cold Rolled A1008 CS Type B	
Color Couleur	Light Grey RAL7035	Finish Fini Textured
Description	6500 MXR 1800mm x 1000mm Back	
Part Number Numéro Pièce	6500MXU181004B	Detail Rev.
Rev.	0	11 / 18

Use gasket program path 6500 MX > 6500 MXR

SEE BILL OF MATERIAL ON LAST PAGE

This drawing is confidential and must not be reproduced or used without the consent of EXM

Ce dessin est confidentiel et ne doit pas être reproduit ou utilisé sans le consentement de EXM

STANDARD FEATURES ARE NOT LISTED IN THIS HOLE TABLE			
HOLE TABLE - FRONT VIEW (CUSTOM FEATURE ONLY)			
CUT-OUT	XDIM	YDIM	DESCRIPTION
1	100.0	100.0	GND STUD M6 x 16mm (Inside)
2	895.0	100.0	GND STUD M6 x 16mm (Inside)

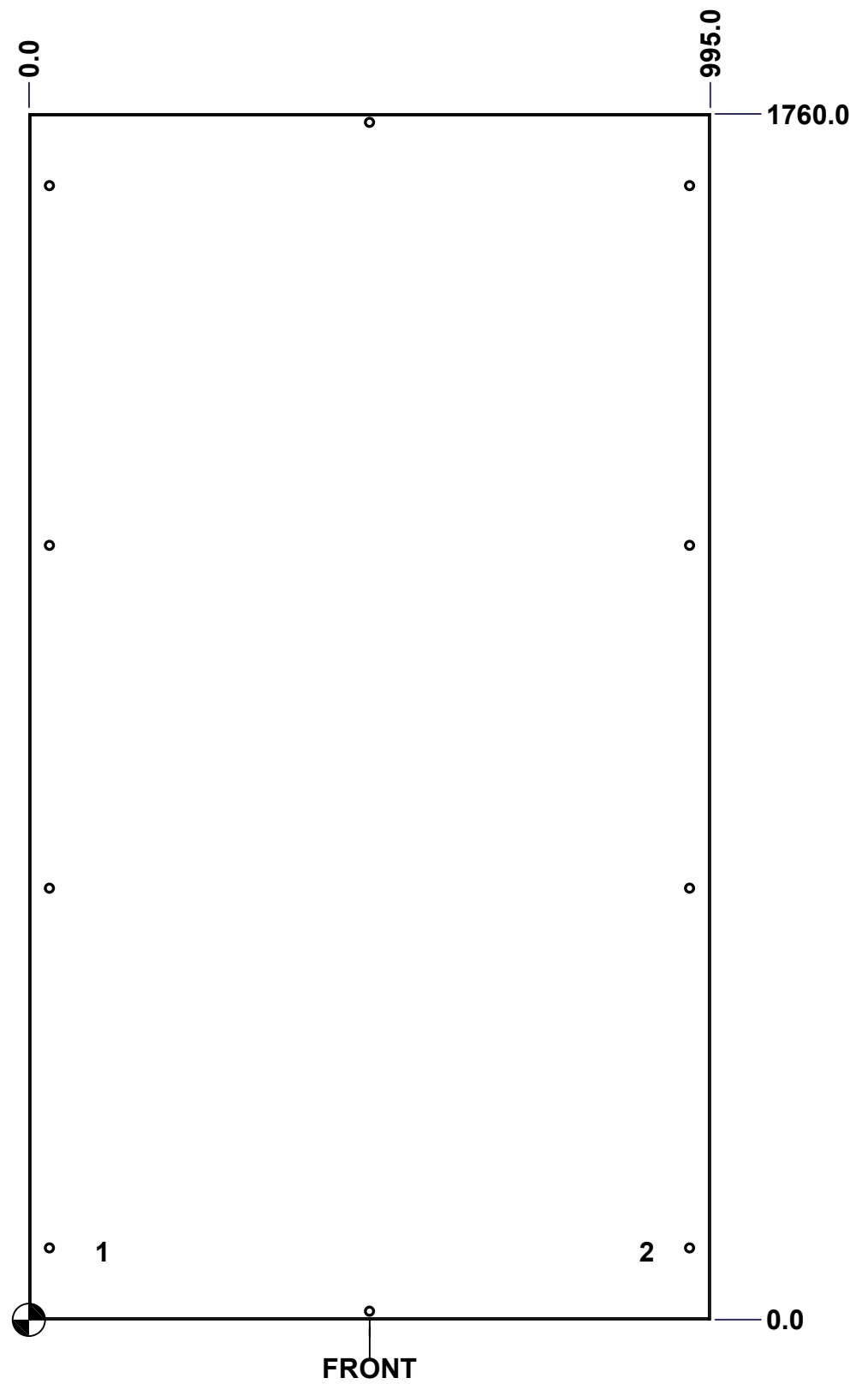

Use bending program path 6500 MX > 6500 MXR

	Description	Status
	6500 MXR 1800mm x 1000mm Back	(NULL)
Part Number Numéro Pièce 6500MXU181004B	Rev.	12
	0	18

This drawing is confidential and must not be reproduced or used without the consent of EXM

Ce dessin est confidentiel et ne doit pas être reproduit ou utilisé sans le consentement de EXM

No.	Revisions	Date	By/Par

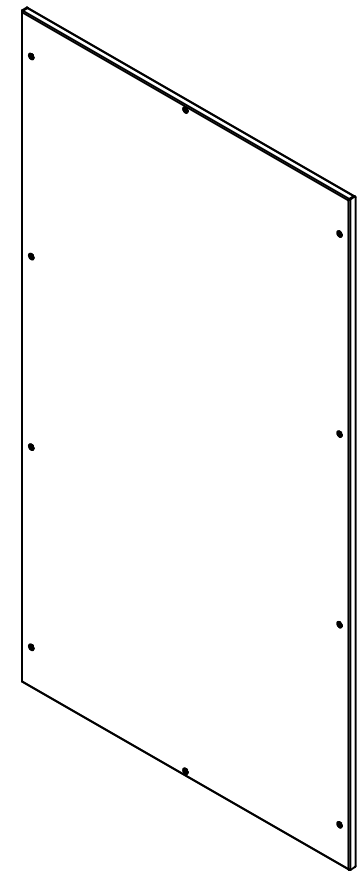

Isometric View

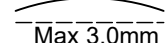

 Tél: (450) 979-4373 Fax: (450) 979-4626 www.exmweb.com		Flatness Aplatissement  Max 3.0mm
Customer Client		Date
Drawn By / Dessiné Par: BoxCad: BoxCad		Date: 09-Mar-15
Material / Matière: 14 Ga Cold Rolled A1008 CS Type B		
Color / Couleur: Light Grey RAL7035	Finish / Fini: Textured	
Description: 6500 MXR 1800mm x 1000mm Back		Detail Rev.
Part Number / Numéro Pièce: 6500MXU181004B		Rev. 0

Qty	Part Number	Rev	Description
1	STK-P-03820R	0	Powder Paint (Light Grey / Rough Textured)
1	6500MXU181004BG	0	6500 MXR 1800mm x 1000mm Back Gasket
10	STK-Q-03071	0	M6 x 16mm Machine Screw
2	STK-Q-16080	0	Ground Stud M6 x 16mm Steel
1	6500MXU181004B-P	0	6500 MXR 1800mm x 1000mm Back Part
Parts List			

This drawing is confidential and must not be reproduced or used without the consent of EXM

Ce dessin est confidentiel et ne doit pas être reproduit ou utilisé sans le consentement de EXM

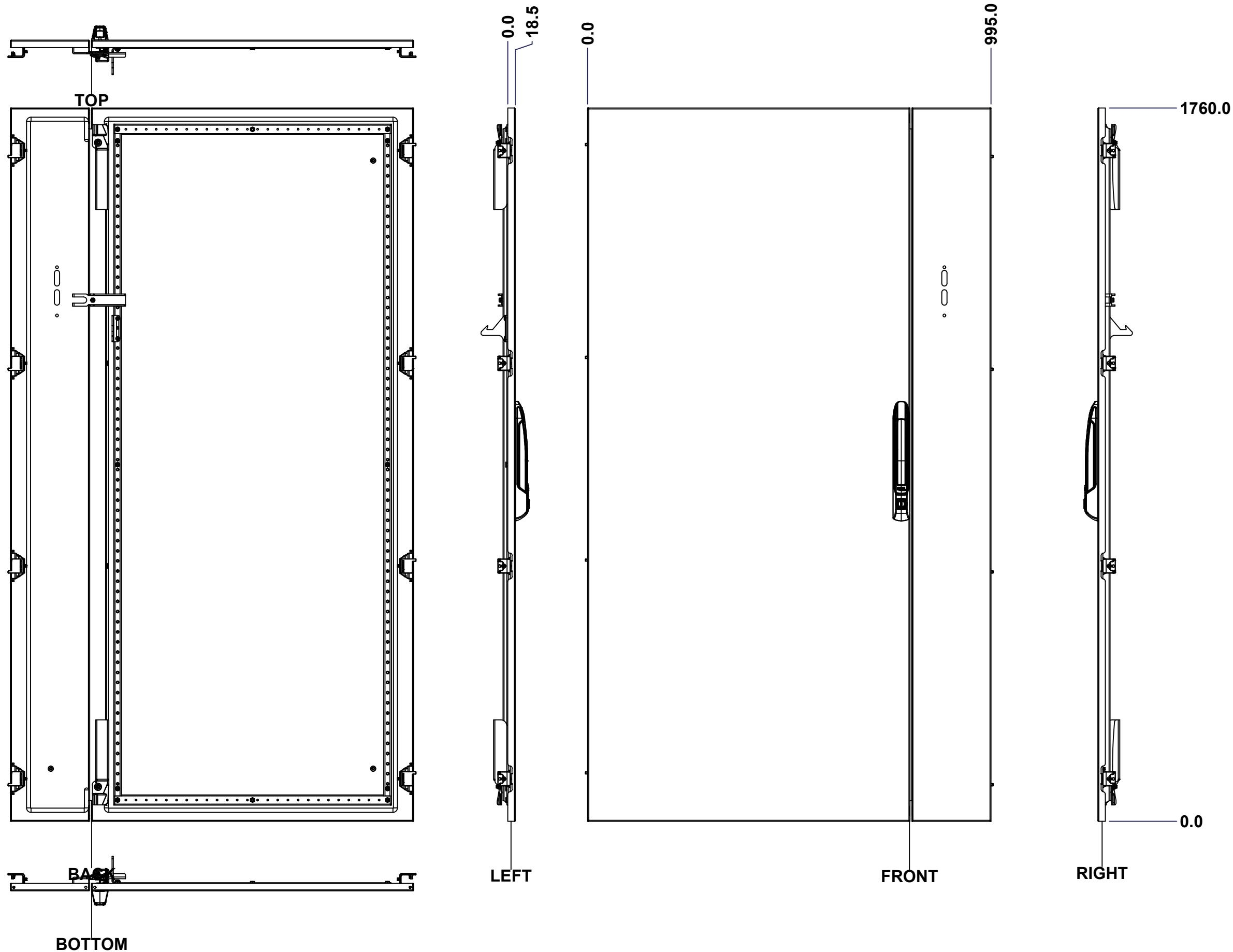

No.	Revisions	Date	By/Par

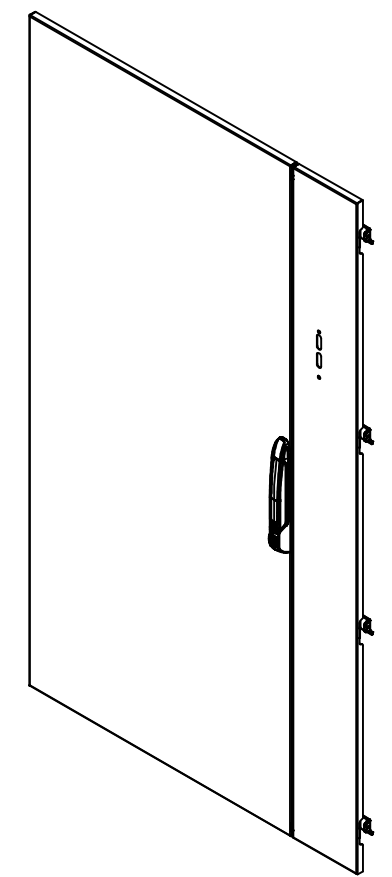

Isometric View

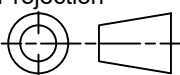

 Tél: (450) 979-4373 Fax: (450) 979-4626 www.exmweb.com	Flatness Aplatissement
	Max 3.0mm
Projection	
Customer Client	Date
Drawn By Dessiné Par	Date 09-Mar-15
Material Matière	14 Ga Cold Rolled A1008 CS Type B
Color Couleur	Light Grey RAL7035
Finish Fini	Textured
Description	Detail Rev.
6500 MXDU 1800mm x 1000mm Front	
Part Number Numéro Pièce	Rev.
6500MXU181004F	0
	14
	18

Use gasket program path 6500 MX > 6500 MXDU

SEE BILL OF MATERIAL ON LAST PAGE

This drawing is confidential and must not be reproduced or used without the consent of EXM

Ce dessin est confidentiel et ne doit pas être reproduit ou utilisé sans le consentement de EXM

STANDARD FEATURES ARE NOT LISTED IN THIS HOLE TABLE

HOLE TABLE - FRONT VIEW (CUSTOM FEATURE ONLY)

CUT-OUT	XDIM	YDIM	DESCRIPTION
1	100.0	130.0	GND STUD M6 x 16mm (Inside)
2	100.0	1630.0	GND STUD M6 x 16mm (Inside)
3	895.0	130.0	GND STUD M6 x 16mm (Inside)
4	64.5	52.8	STIFF. STUD M6 x 18mm (Inside)
5	64.5	880.0	STIFF. STUD M6 x 18mm (Inside)
6	64.5	1707.2	STIFF. STUD M6 x 18mm (Inside)
7	64.5	1679.0	STIFF. STUD M6 x 18mm (Inside)
8	64.5	81.0	STIFF. STUD M6 x 18mm (Inside)
9	730.5	52.8	STIFF. STUD M6 x 18mm (Inside)
10	730.5	880.0	STIFF. STUD M6 x 18mm (Inside)
11	730.5	1707.2	STIFF. STUD M6 x 18mm (Inside)
12	730.5	1679.0	STIFF. STUD M6 x 18mm (Inside)
13	730.5	81.0	STIFF. STUD M6 x 18mm (Inside)
14	774.0	170.0	LARGE CBAR GUIDE (Inside)
15	774.0	1590.0	LARGE CBAR GUIDE (Inside)
16	774.0	680.0	LARGE CBAR GUIDE (Inside)
17	774.0	1080.0	LARGE CBAR GUIDE (Inside)

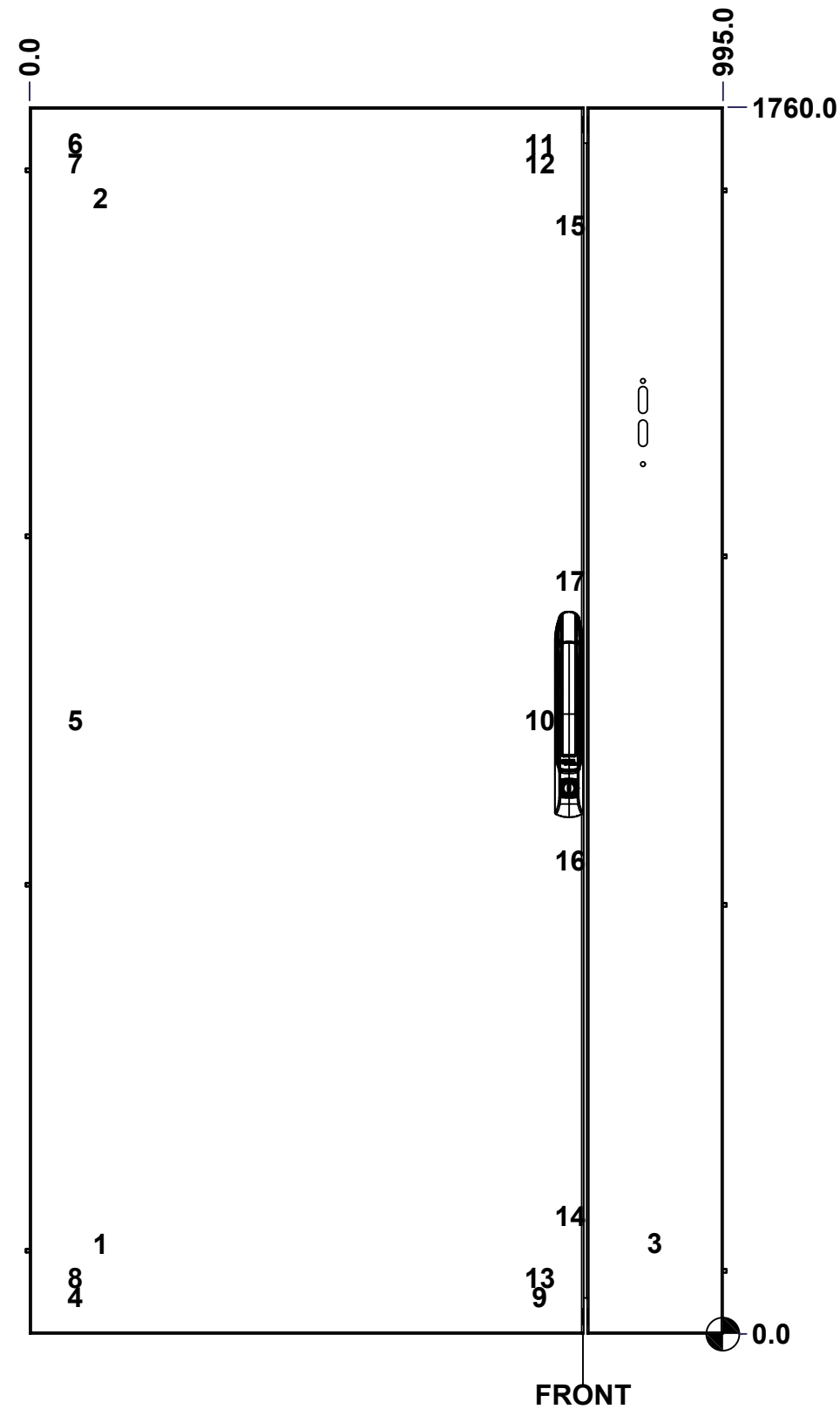

Use bending program path 6500 MX > 6500 MXDU

	Description		Status
	6500 MXDU 1800mm x 1000mm Front		(NULL)
	Part Number Numéro Pièce		Rev.
	6500MXU181004F		0 / 15

This drawing is confidential and must not be reproduced or used without the consent of EXM

Ce dessin est confidentiel et ne doit pas être reproduit ou utilisé sans le consentement de EXM

No.	Revisions	Date	By/Par

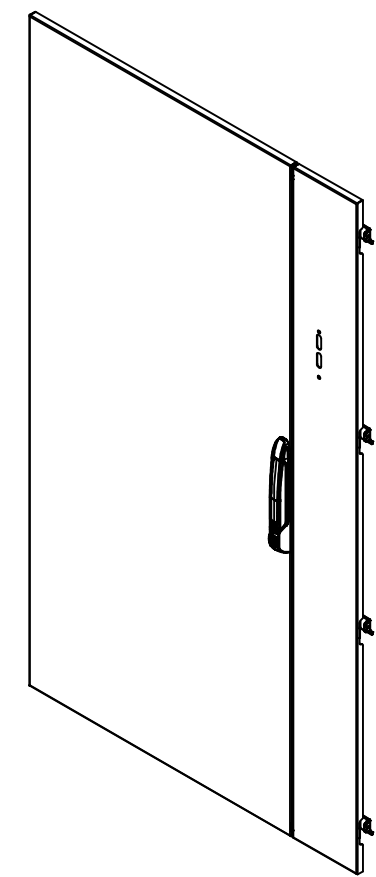

Isometric View



1	STK-P-03820R	0	Powder Paint (Light Grey / Rough Textured)
1	STK-A-51160	0	886PH2-SL - Pull Handle Lock - Assembly
1	STK-Q-45758	1	886 PH2 Pull Handle Bridge Part
4	STK-Q-16410	0	Guide Stud - Large (No Paint Cap Required)
4	STK-A-70586	3	Fixed Double Door Bracket Assembly
1	STK-Q-45652-18	1	6500 MX - Lower Closing Bar 1800mm
1	STK-Q-45651-18	1	6500 MX - Upper Closing Bar 1800mm
1	STK-Q-46650	3	6500 MXDU Disconnect Hook
8	STK-K-06810	7	6500 MX Hinge Assy
2	STK-Q-05020	5	M5 x 8mm Thread Rolling Screw
1	STK-Q-07220	0	M6 Nylon Insert Lock Nut
1	STK-Q-46750	4	6500 MXDU Disconnect Defeater
1	STK-K-10102	3	6500MX - Lock Handle Kit for Flange Door - Right
1	STK-K-10101	3	6500MX - Lock Handle Kit for Flange Door - Left
1	STK-Q-16030	0	Stud M6 x 10mm
2	STK-Q-16050	0	Stud M6 x 18mm
1	6500MXU181004F1G	0	6500 MXDU 1800mm x 1000mm Front Gasket
1	6500MXU181004F1-P	0	6500 MXDU 1800mm x 1000mm Front Part
10	STK-Q-16055	1	M6 x 18mm Stud (No Paint Cap Required)
3	STK-Q-16080	0.1.1	Ground Stud M6 x 16mm Steel
1	6500MXU181004DS1	5	6500 MX 1800mm x 1000mm Door Stiffener
1	6500MXU181004FG	0	6500 MXDU 1800mm x 1000mm Front Gasket
1	6500MXU181004F-P	0	6500 MXDU 1800mm x 1000mm Front Part

Qty	Part Number	Rev.	Description
Parts List			

Tél: (450) 979-4373 Fax: (450) 979-4626 www.exmweb.com	Flatness Aplatissement
	Max 3.0mm
Projection	
Customer Client	Date
Drawn By Dessiné Par	Date 09-Mar-15
Material Matière	14 Ga Cold Rolled A1008 CS Type B
Color Couleur	Light Grey RAL7035
Finish Fini	Textured
Description	Detail Rev.
6500 MXDU 1800mm x 1000mm Front	
Part Number Numéro Pièce	Rev. 16
6500MXU181004F	0 18

This drawing is confidential and must not be reproduced or used without the consent of EXM

Ce dessin est confidentiel et ne doit pas être reproduit ou utilisé sans le consentement de EXM

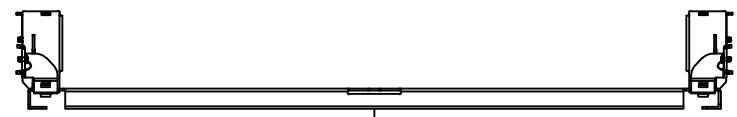

TOP

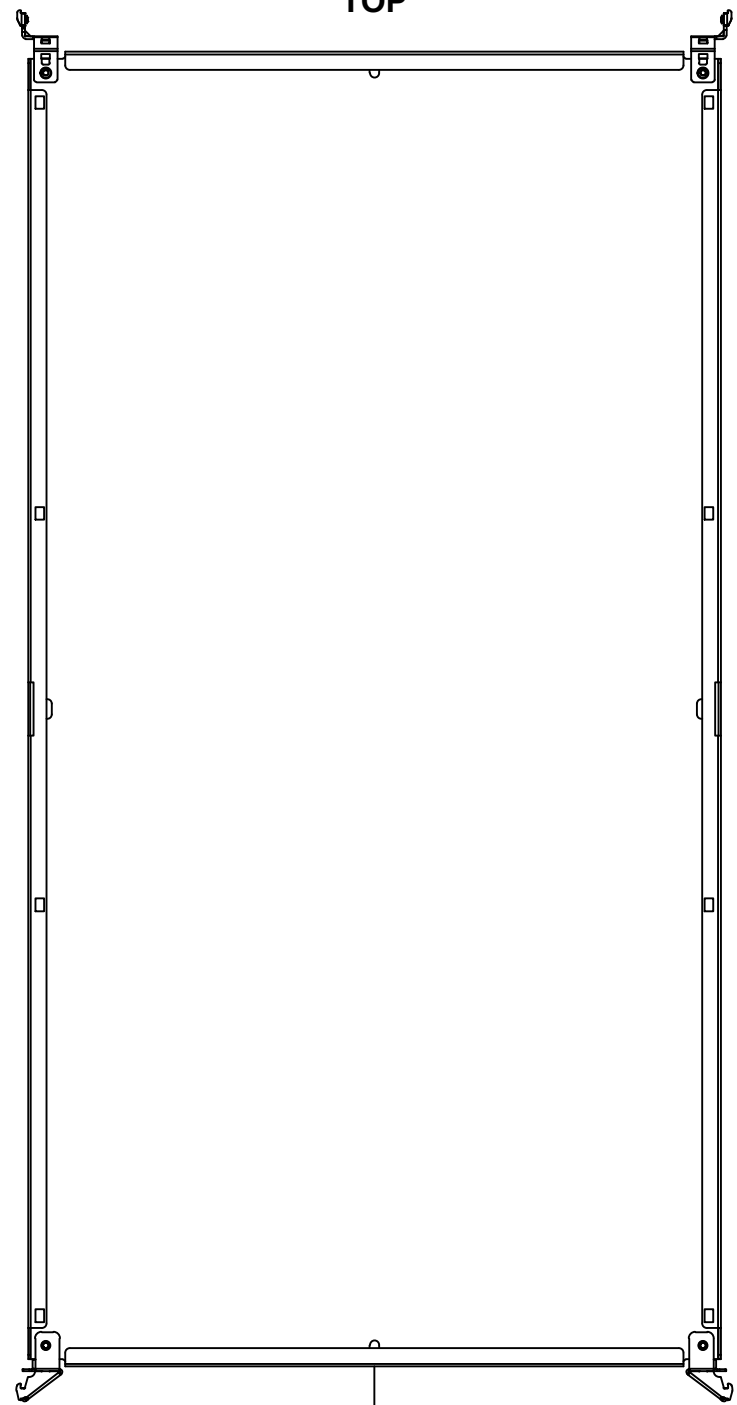

BACK

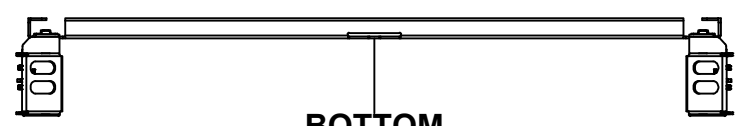

BOTTOM

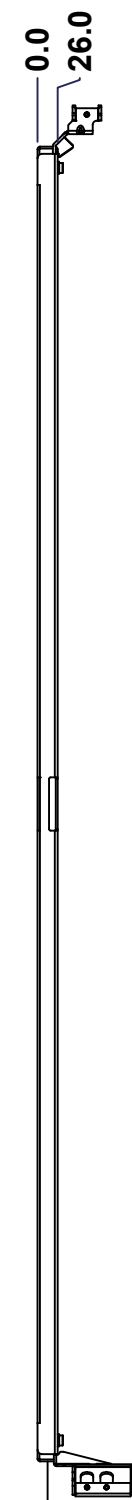

LEFT

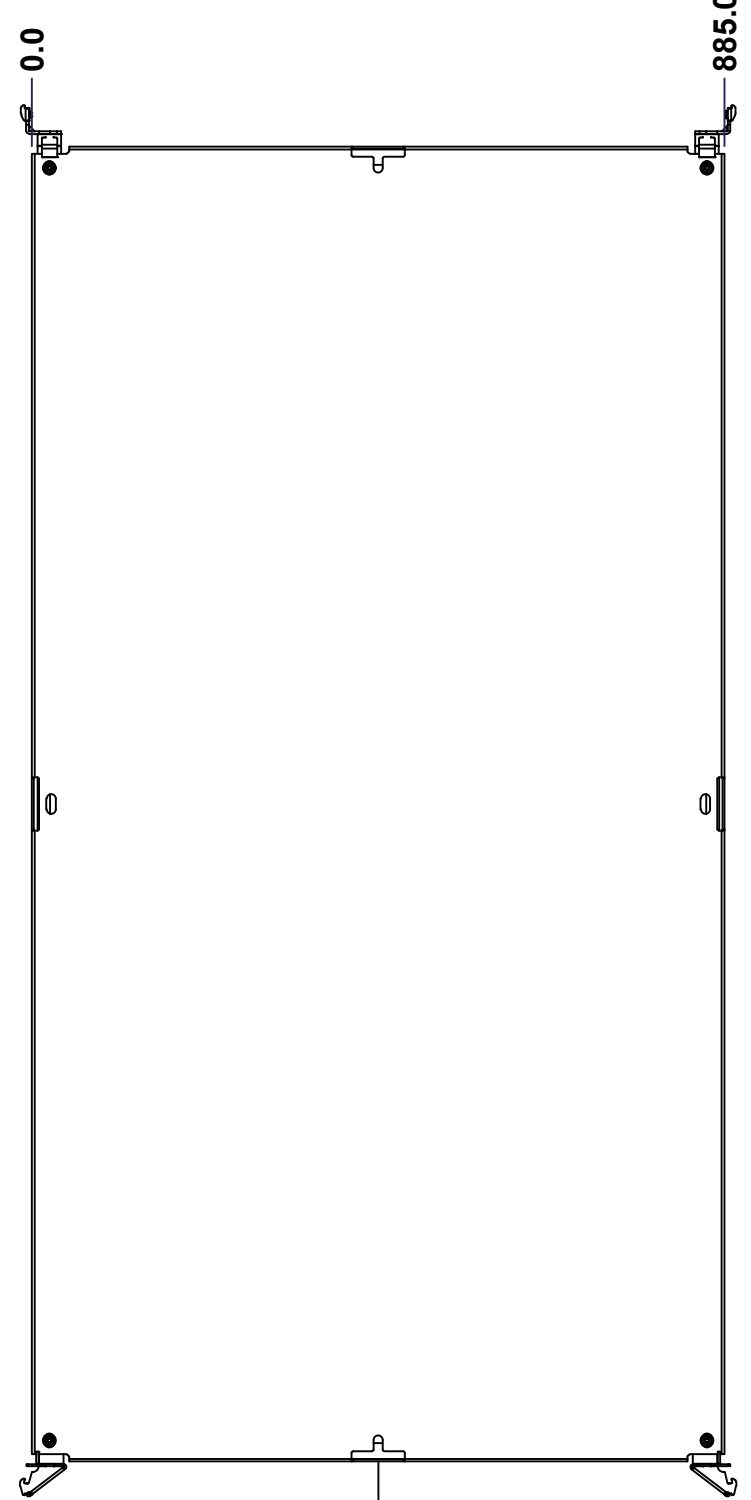

FRONT

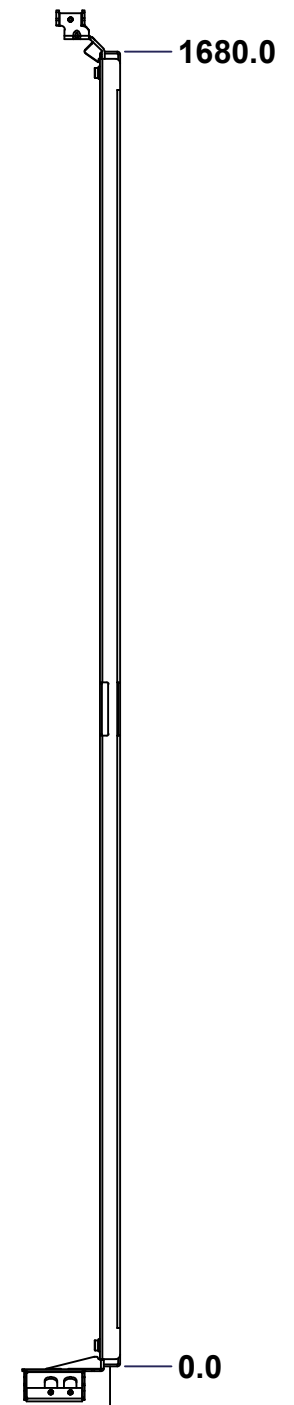

RIGHT

No.	Revisions	Date	By/Par

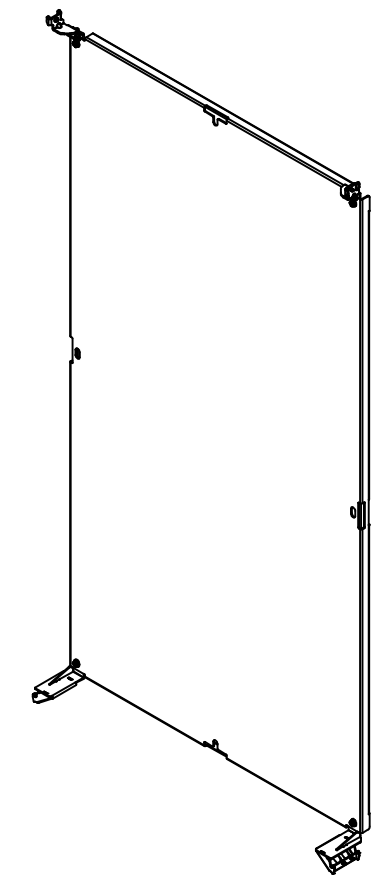

Isometric View



Tél: (450) 979-4373
 Fax: (450) 979-4626
www.exmweb.com

Flatness
 Aplatissement
 Max 3.0mm
 Projection

Customer Client	Date
Drawn By Dessiné Par BoxCad: BoxCad	Date 09-Mar-15
Material Matière 12 Ga Galvanized (2.5mm)	

Color Couleur Unpainted	Finish Fini Unpainted
----------------------------	--------------------------

Description 6500 MXM 1800mm x 1000mm Back Inner Panel	Detail Rev.
--	-------------

Part Number Numéro Pièce 6500MXU181004BIP	Rev. 0	17 18
---	---------------	----------

SEE BILL OF MATERIAL ON LAST PAGE

This drawing is confidential and must not be reproduced or used without the consent of EXM

Ce dessin est confidentiel et ne doit pas être reproduit ou utilisé sans le consentement de EXM

No.	Revisions	Date	By/Par

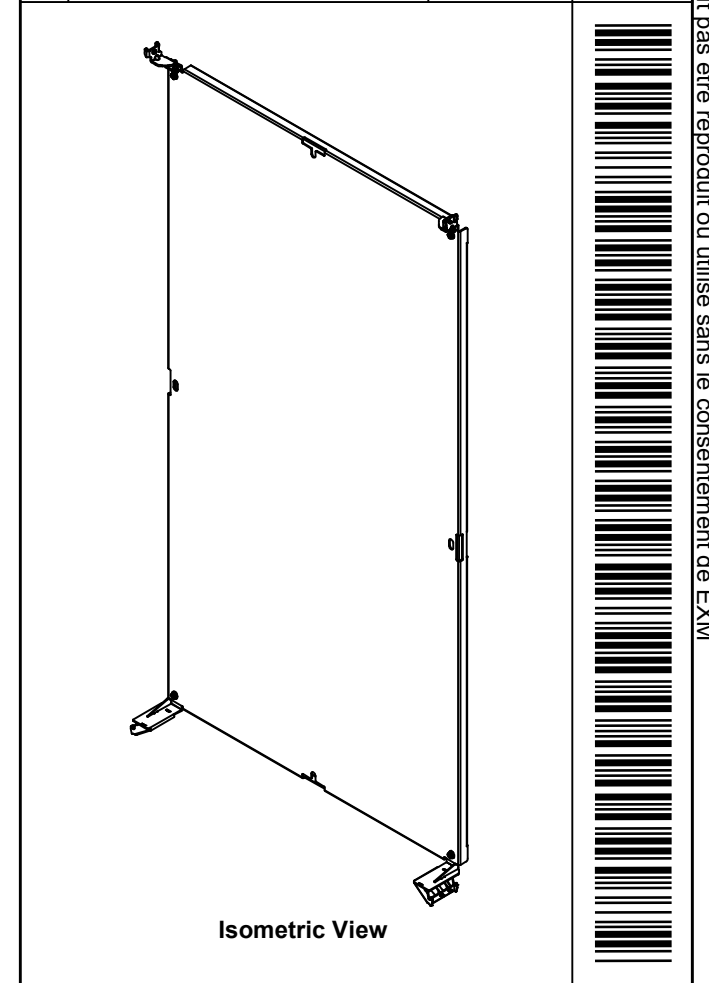

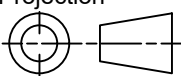
 Tél: (450) 979-4373 Fax: (450) 979-4626 www.exmweb.com		Flatness Aplatissement Max 3.0mm Projection 
Customer Client	Date	
Drawn By Dessiné Par	BoxCad: BoxCad	Date 09-Mar-15
Material Matière	12 Ga Galvanized (2.5mm)	
Color Couleur	Unpainted	Finish Fini Unpainted
Description 6500 MXM 1800mm x 1000mm Back Inner Panel		Detail Rev.
Part Number Numéro Pièce	6500MXU181004BIP	Rev. 18 0 18

Qty	Part Number	Rev	Description
1	STK-A-49005	5	6500 MXM - Bottom Inner Panel Support Assembly (Right)
1	STK-A-49000	5	6500 MXM - Bottom Inner Panel Support Assembly (Left)
1	STK-A-49015	0	6500MXM - Top Inner Panel Support Kit (Right)
1	STK-A-49010	0	6500MXM - Top Inner Panel Support Kit (Left)
1	6500MXU181004BIP-P	0	6500 MXM 1800mm x 1000mm Back Inner Panel Part
Parts List			