

This drawing is confidential and must not be reproduced or used without the consent of EXM

Ce dessin est confidentiel et ne doit pas être reproduit ou utilisé sans le consentement de EXM

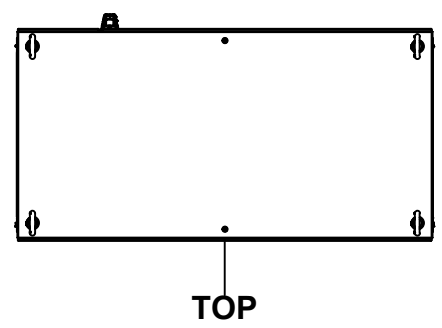

TOP

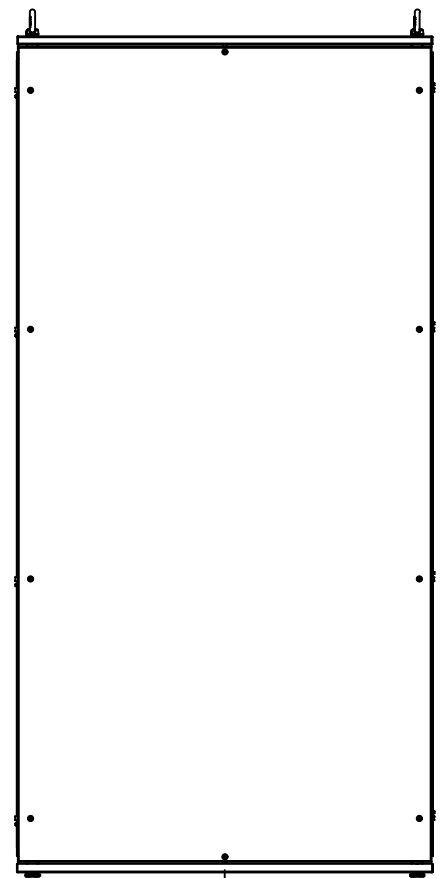

BACK

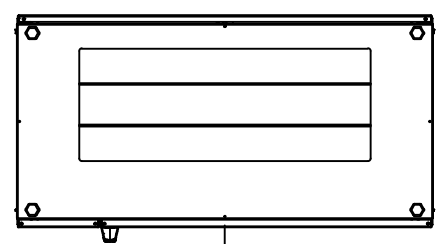

BOTTOM

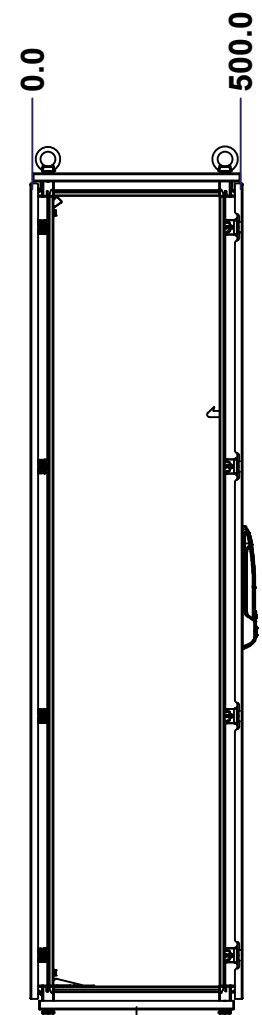

LEFT

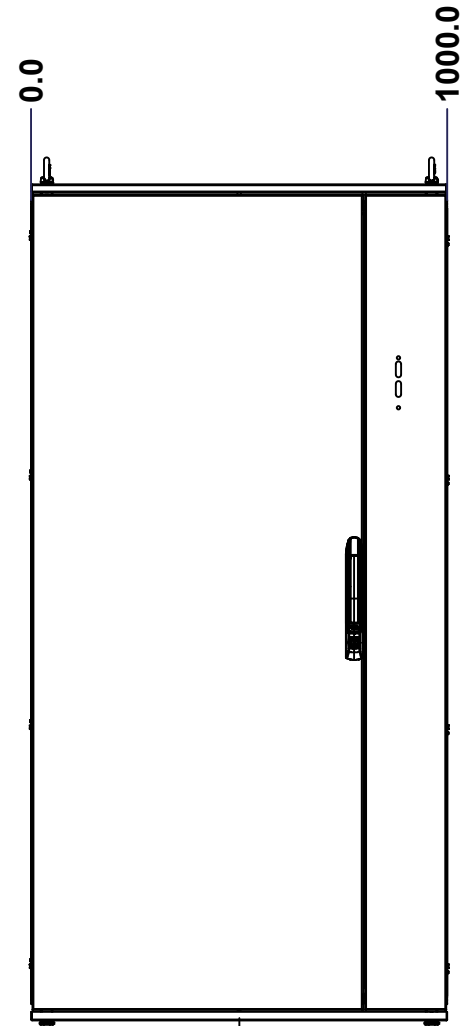

FRONT

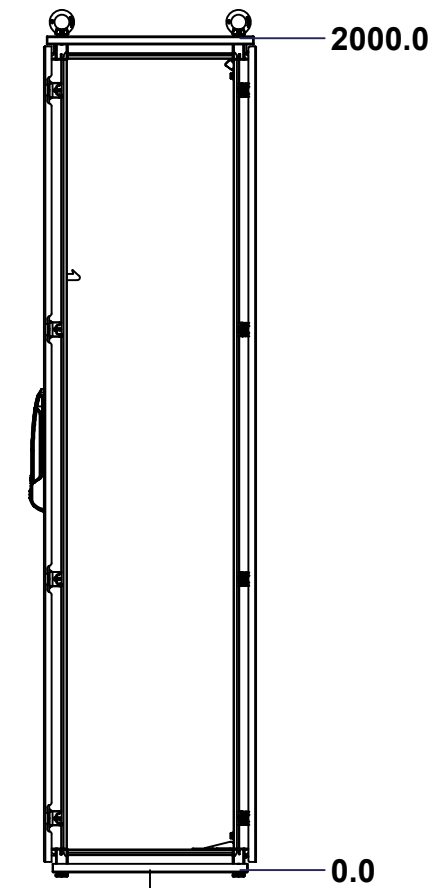

RIGHT

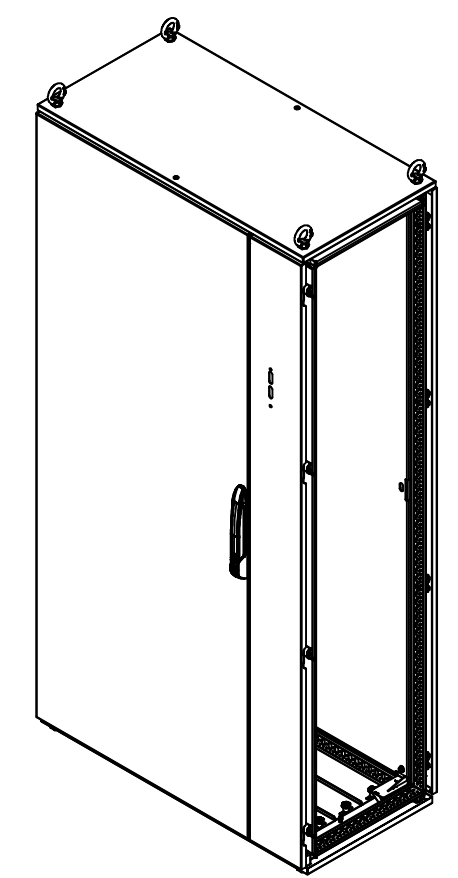

Isometric View

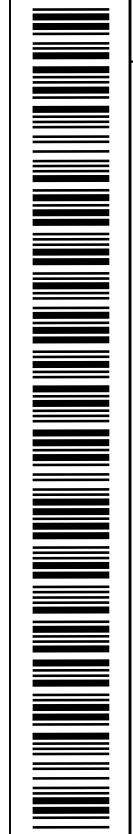

No.	Revisions	Date	By/Par



Tél: (450) 979-4373  
 Fax: (450) 979-4626  
[www.exmweb.com](http://www.exmweb.com)

Flatness  
Aplatissement  
Max 3.0mm  
Projection

Customer Client	Date
Drawn By Dessiné Par BoxCad: BoxCad	Date 10-Mar-15
Material Matière	See Part List
Color Couleur	See Part List
Finish Fini	See Part List
Description 6500MX 2000mm x 1000mm x 500mm Assembly	Detail Rev.
Part Number Numéro Pièce <b>6500MXU201005</b>	Rev. 1 <b>0</b>

SEE BILL OF MATERIAL ON LAST PAGE

This drawing is confidential and must not be reproduced or used without the consent of EXM

Ce dessin est confidentiel et ne doit pas être reproduit ou utilisé sans le consentement de EXM

No.	Revisions	Date	By/Par

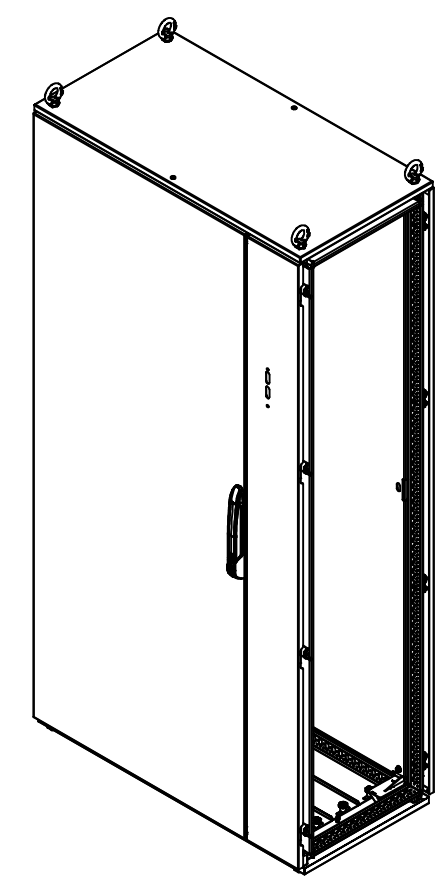

Isometric View



Tél: (450) 979-4373  
 Fax: (450) 979-4626  
[www.exmweb.com](http://www.exmweb.com)

Flatness  
Aplatissement  
Max 3.0mm  
Projection

Customer Client	Date
Drawn By / Dessiné Par: BoxCad: BoxCad	Date: 10-Mar-15
Material / Matière	See Part List

Color / Couleur	See Part List	Finish / Fini	See Part List
Description		Detail Rev.	
6500MX 2000mm x 1000mm x 500mm Assembly			

Part Number / Numéro Pièce	Rev.	2
<b>6500MXU201005</b>	<b>0</b>	18

Qty	Part Number	Rev	Description
1	6500MXU201005BIP	0	6500 MXM 2000mm x 1000mm Back Inner Panel
1	6500MXU201005F	0	6500 MXDU 2000mm x 1000mm Front
1	6500MXU201005B	0	6500 MXR 2000mm x 1000mm Back
1	6500MXU201005BT	0	6500 MXB 1000mm x 500mm Bottom
1	6500MXU201005T	0	6500 MXT 1000mm x 500mm Top
1	6500MXU201005FR	0	6500 MX 2000mm x 1000mm x 500mm Frame
Parts List			

This drawing is confidential and must not be reproduced or used without the consent of EXM

Ce dessin est confidentiel et ne doit pas être reproduit ou utilisé sans le consentement de EXM

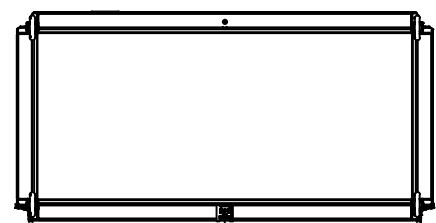

TOP

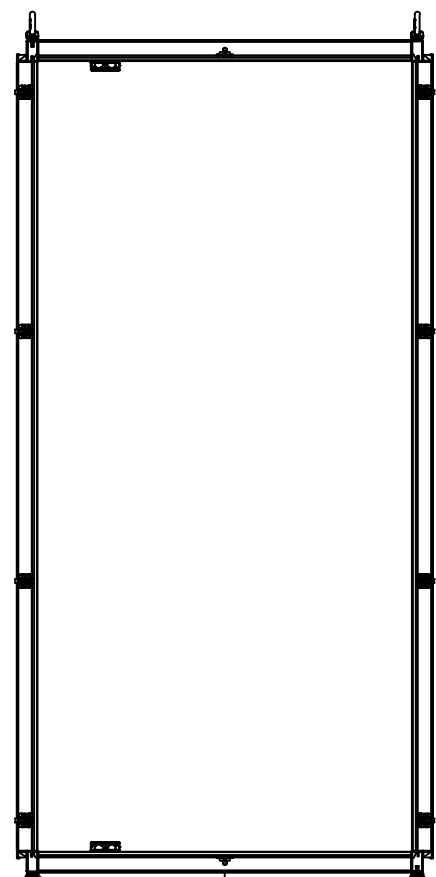

BACK

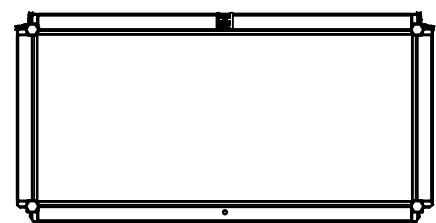

BOTTOM

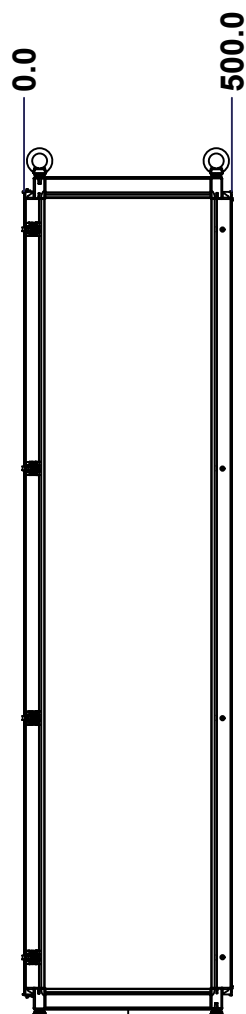

LEFT

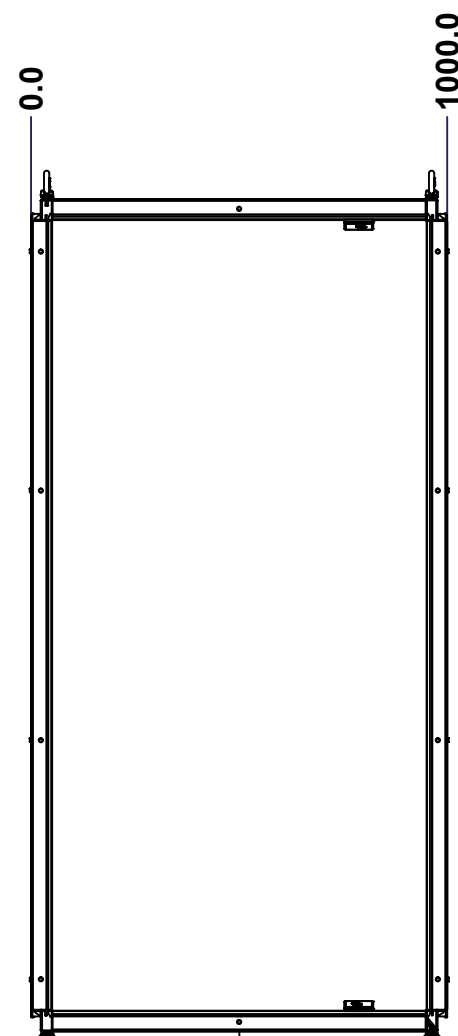

FRONT

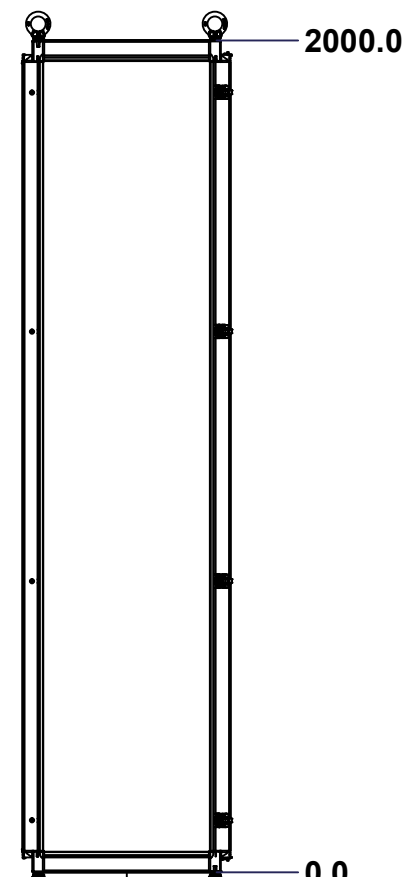

RIGHT

Grind excess weld off corner(s)

No.	Revisions	Date	By/Par

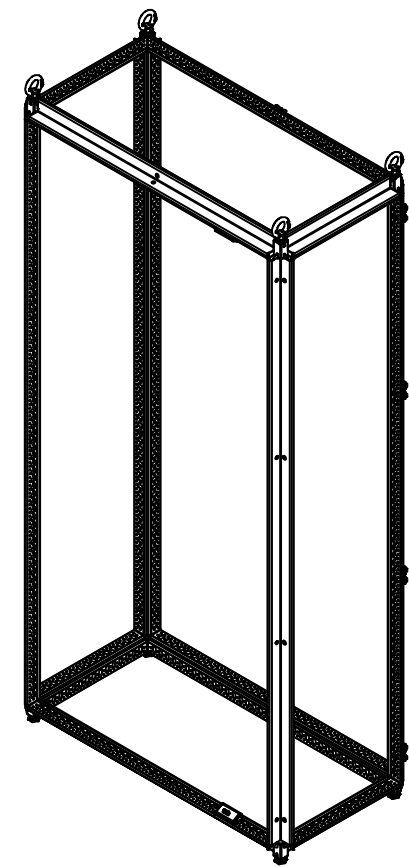

Isometric View



Tél: (450) 979-4373  
 Fax: (450) 979-4626  
[www.exmweb.com](http://www.exmweb.com)

Flatness  
Aplatissement  
Max 3.0mm  
Projection

Customer Client	Date
Drawn By Dessiné Par BoxCad: BoxCad	Date 10-Mar-15
Material Matière	16 Ga Electro-Galvanized (1.4mm)

Color Couleur	Iron Grey RAL7011	Finish Fini	Textured
------------------	-------------------	----------------	----------

Description	Detail Rev.
6500 MX 2000mm x 1000mm x 500mm Frame	

Part Number Numéro Pièce	Rev.	3
<b>6500MXU201005FR</b>	<b>0</b>	18

SEE BILL OF MATERIAL ON LAST PAGE

This drawing is confidential and must not be reproduced or used without the consent of EXM

Ce dessin est confidentiel et ne doit pas être reproduit ou utilisé sans le consentement de EXM

No.	Revisions	Date	By/Par

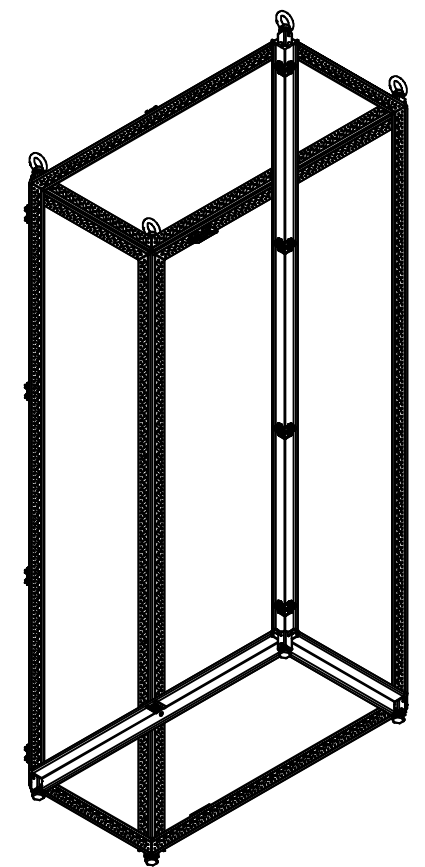

Isometric View



1	STK-P-03810ST	0	Powder Paint (Iron Grey /Sand Textured)
1	STK-Q-04000	4	M6.0 x 9.5mm Truss Head Tapping Screw
2	STK-Q-70486	0	6500 MX Single Rear Panel Bracket
4	STK-Q-47250-10	6	6500 MX 1000mm Horizontal Frame Post Part
4	STK-Q-47250-05	6	6500 MX 500mm Horizontal Frame Post Part
2	STK-Q-05020	5	M5 x 8mm Thread Rolling Screw
2	STK-A-74730	2	6500 MX - Flange Door Sealing Block
21	STK-Q-77120	1	6500MX-Frame Rubber Plug
8	STK-A-70580	9	Mtrx Bracket
8	STK-Q-00610	3	M16 x 30.0mm Bolt
8	STK-A-49448	6	6500 MX - Frame Sheet Metal Corner Assembly
4	STK-Q-49500	3	M12 Eye Bolt (0.34T)
4	STK-Q-61110	0	M12 Feet Leveler
4	STK-Q-47251-20	6	6500 MX 2000mm Vertical Frame Post Part
Qty	Part Number	Rev	Description
Parts List			

	Tél: (450) 979-4373 Fax: (450) 979-4626 <a href="http://www.exmweb.com">www.exmweb.com</a>	Flatness Aplatissement Max 3.0mm
		Projection 
Customer Client		Date
Drawn By Dessiné Par	BoxCad: BoxCad	Date 10-Mar-15
Material Matière	16 Ga Electro-Galvanized (1.4mm)	
Color Couleur	Iron Grey RAL7011	Finish Fini Textured
Description	6500 MX 2000mm x 1000mm x 500mm Frame	
Part Number Numéro Pièce	<b>6500MXU201005FR</b>	Detail Rev.
		Rev. 4
		0
		18

This drawing is confidential and must not be reproduced or used without the consent of EXM

Ce dessin est confidentiel et ne doit pas être reproduit ou utilisé sans le consentement de EXM

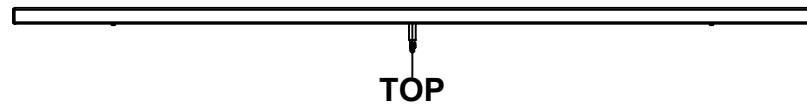

TOP

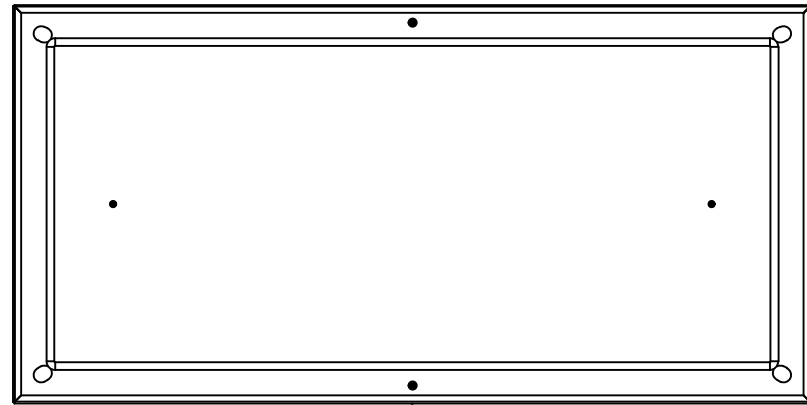

BACK

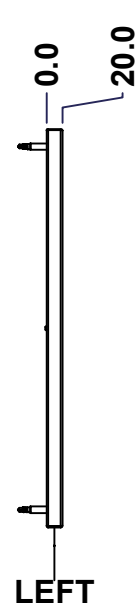

LEFT

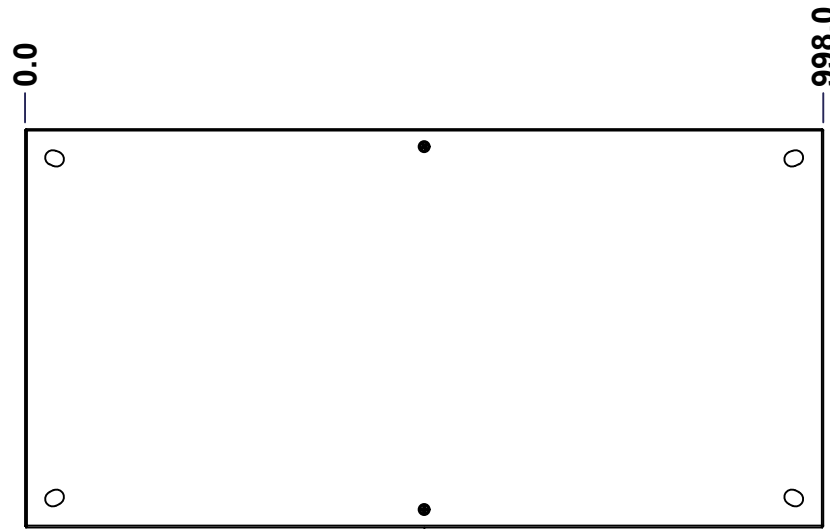

FRONT

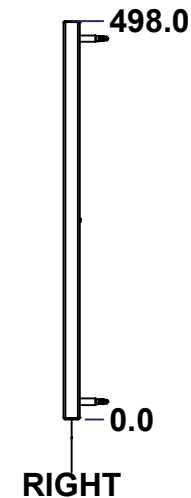

RIGHT

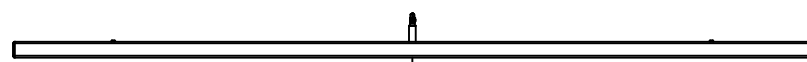

BOTTOM

No.	Revisions	Date	By/Par

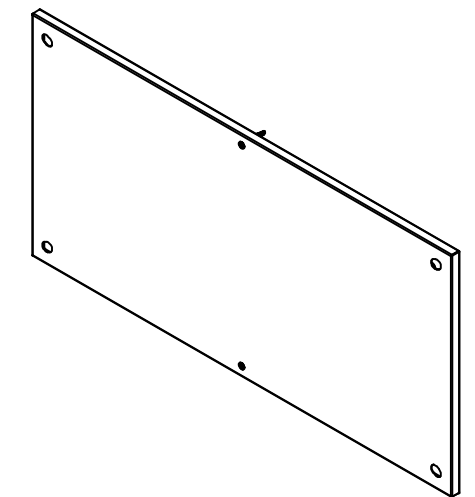

Isometric View



Tél: (450) 979-4373  
 Fax: (450) 979-4626  
[www.exmweb.com](http://www.exmweb.com)

Flatness  
Aplatissement

Max 3.0mm

Projection

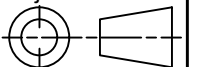

Customer Client	Date
Drawn By / Dessiné Par: BoxCad: BoxCad	Date: 10-Mar-15
Material / Matière: 16 Ga Cold Rolled A1008 CS Type B	
Color / Couleur: Iron Grey RAL7011	Finish / Fini: Textured
Description: 6500 MXT 1000mm x 500mm Top	Detail Rev.
Part Number / Numéro Pièce: 6500MXU201005T	Rev. 5
	0

Use gasket program path 6500 MX > 6500 MXT

SEE BILL OF MATERIAL ON LAST PAGE

This drawing is confidential and must not be reproduced or used without the consent of EXM

Ce dessin est confidentiel et ne doit pas être reproduit ou utilisé sans le consentement de EXM

STANDARD FEATURES ARE NOT LISTED IN THIS HOLE TABLE			
HOLE TABLE - FRONT VIEW (CUSTOM FEATURE ONLY)			
CUT-OUT	XDIM	YDIM	DESCRIPTION
1	125.0	249.0	GND STUD M6 x 18mm (Inside)
2	873.0	249.0	GND STUD M6 x 18mm (Inside)

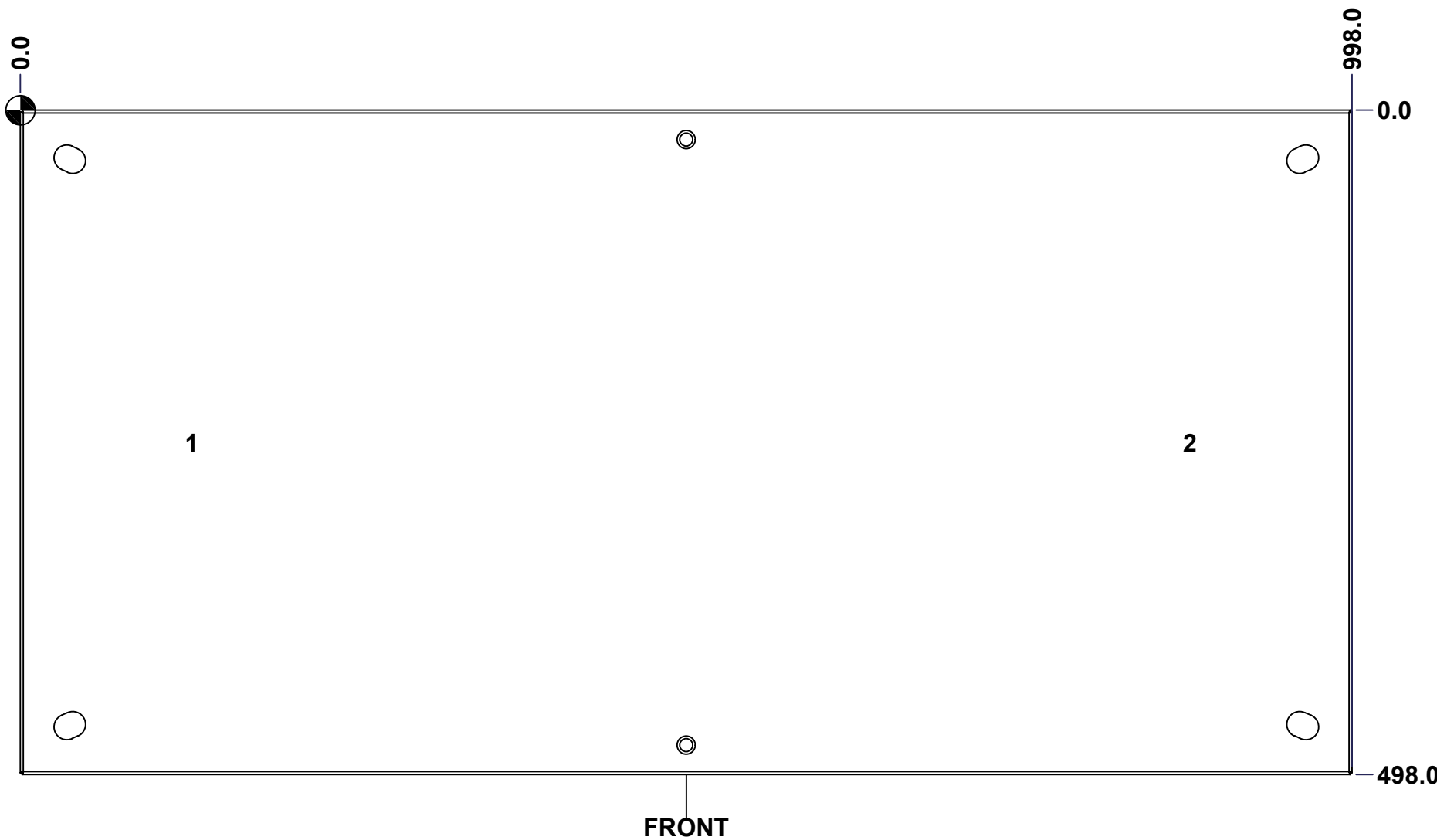

Use bending program path 6500 MX > 6500 MXT

	Description	Status
	6500 MXT 1000mm x 500mm Top	(NULL)
	Part Number Numéro Pièce	Rev.
	<b>6500MXU201005T</b>	<b>0</b> / 6
		18

This drawing is confidential and must not be reproduced or used without the consent of EXM

Ce dessin est confidentiel et ne doit pas être reproduit ou utilisé sans le consentement de EXM

No.	Revisions	Date	By/Par

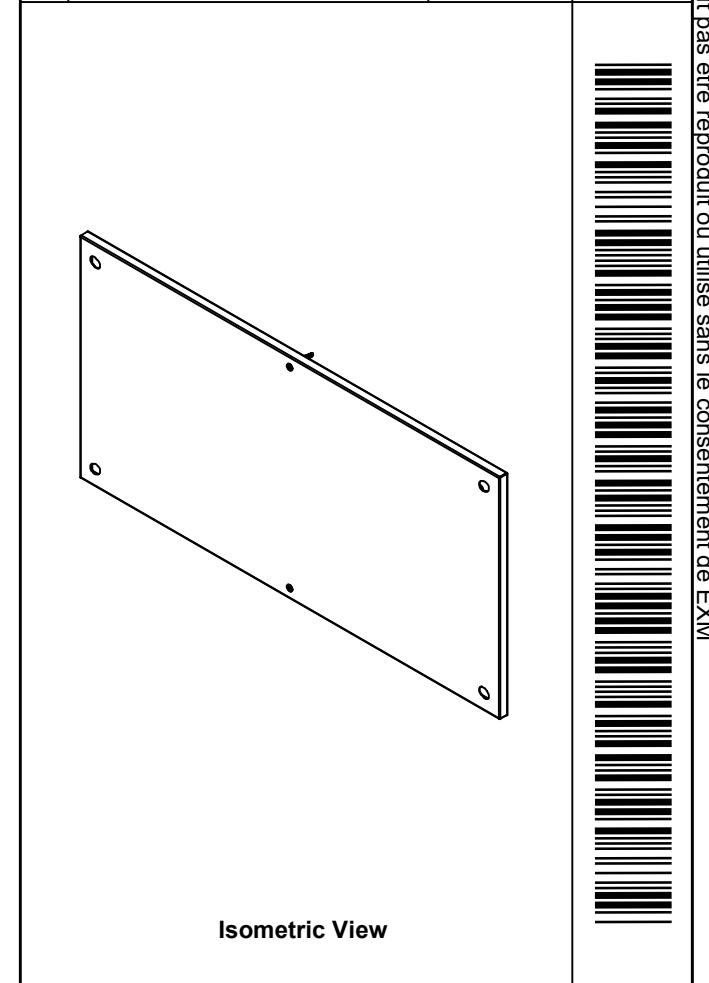

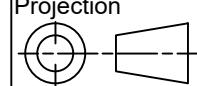
 Tél: (450) 979-4373 Fax: (450) 979-4626 <a href="http://www.exmweb.com">www.exmweb.com</a>		Flatness Aplatissement Max 3.0mm Projection 
Customer Client	Date	
Drawn By Dessiné Par	BoxCad: BoxCad	Date 10-Mar-15
Material Matière	16 Ga Cold Rolled A1008 CS Type B	
Color Couleur	Iron Grey RAL7011	Finish Fini Textured
Description	Detail Rev.	
6500 MXT 1000mm x 500mm Top		
Part Number Numéro Pièce	Rev.	7
<b>6500MXU201005T</b>	<b>0</b>	18

Qty	Part Number	Rev	Description
1	STK-P-03810ST	0	Powder Paint (Iron Grey /Sand Textured)
2	STK-Q-16055	1	M6 x 18mm Stud (No Paint Cap Required)
2	STK-Q-90227	1	Flat Head Drilling Screw M6.3 x 56.0mm Long
1	6500MXU201005TG	0	6500 MXT 1000mm x 500mm Top Gasket
1	6500MXU201005T-P	0	6500 MXT 1000mm x 500mm Top Part
Parts List			

This drawing is confidential and must not be reproduced or used without the consent of EXM

Ce dessin est confidentiel et ne doit pas être reproduit ou utilisé sans le consentement de EXM

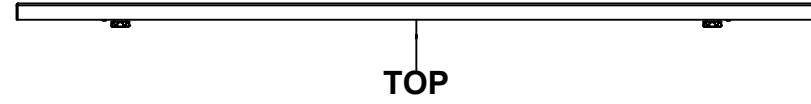

TOP

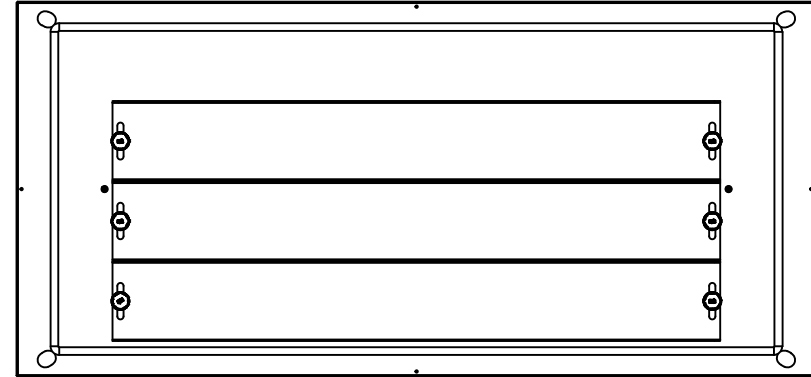

BACK

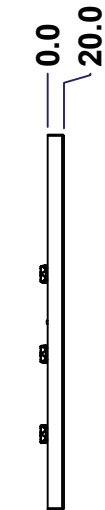

LEFT

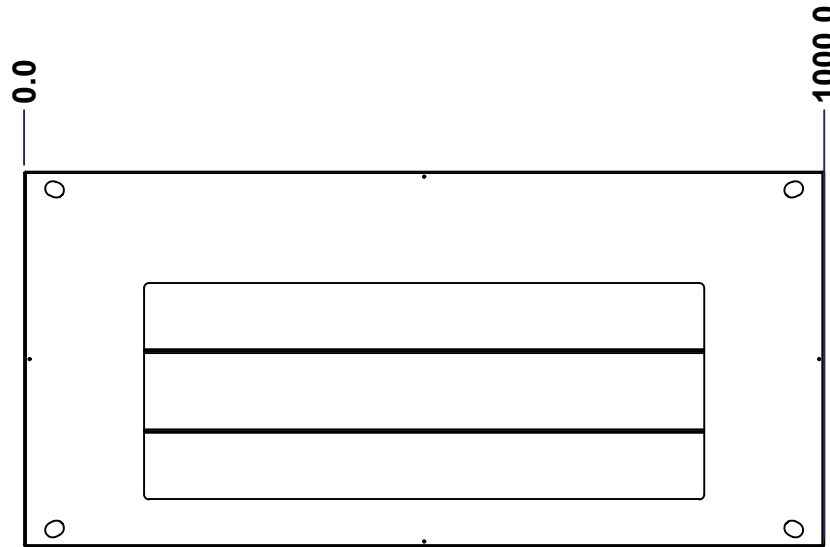

FRONT

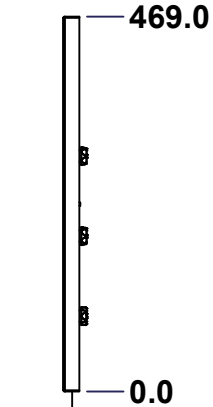

RIGHT

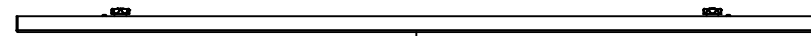

BOTTOM

No.	Revisions	Date	By/Par

**Isometric View**

<p>Tél: (450) 979-4373 Fax: (450) 979-4626 <a href="http://www.exmweb.com">www.exmweb.com</a></p>		Flatness Aplatissement	
		Max 3.0mm	
Customer Client		Date	
Drawn By Dessiné Par		Date	
Material Matière		Projection	
Color Couleur		Finish Fini	
Description		Detail Rev.	
Part Number Numéro Pièce		Rev.	

Use gasket program path 6500 MX > 6500MXB

SEE BILL OF MATERIAL ON LAST PAGE

BoxCad: BoxCad      10-Mar-15  
16 Ga Cold Rolled A1008 CS Type B  
Iron Grey RAL7011      Textured  
6500 MXB 1000mm x 500mm Bottom  
**6500MXU201005BT**      0      8      18

This drawing is confidential and must not be reproduced or used without the consent of EXM

Ce dessin est confidentiel et ne doit pas être reproduit ou utilisé sans le consentement de EXM

**STANDARD FEATURES ARE NOT LISTED IN THIS HOLE TABLE**

**HOLE TABLE - FRONT VIEW (CUSTOM FEATURE ONLY)**

CUT-OUT	XDIM	YDIM	DESCRIPTION
1	110.0	234.5	GND STUD M6 x 18mm (Inside)
2	890.0	234.5	GND STUD M6 x 18mm (Inside)
3	130.0	294.5	GP STUD M6 x 18mm (Inside)
4	870.0	294.5	GP STUD M6 x 18mm (Inside)
5	130.0	194.5	GP STUD M6 x 18mm (Inside)
6	870.0	194.5	GP STUD M6 x 18mm (Inside)
7	130.0	94.5	GP STUD M6 x 18mm (Inside)
8	870.0	94.5	GP STUD M6 x 18mm (Inside)

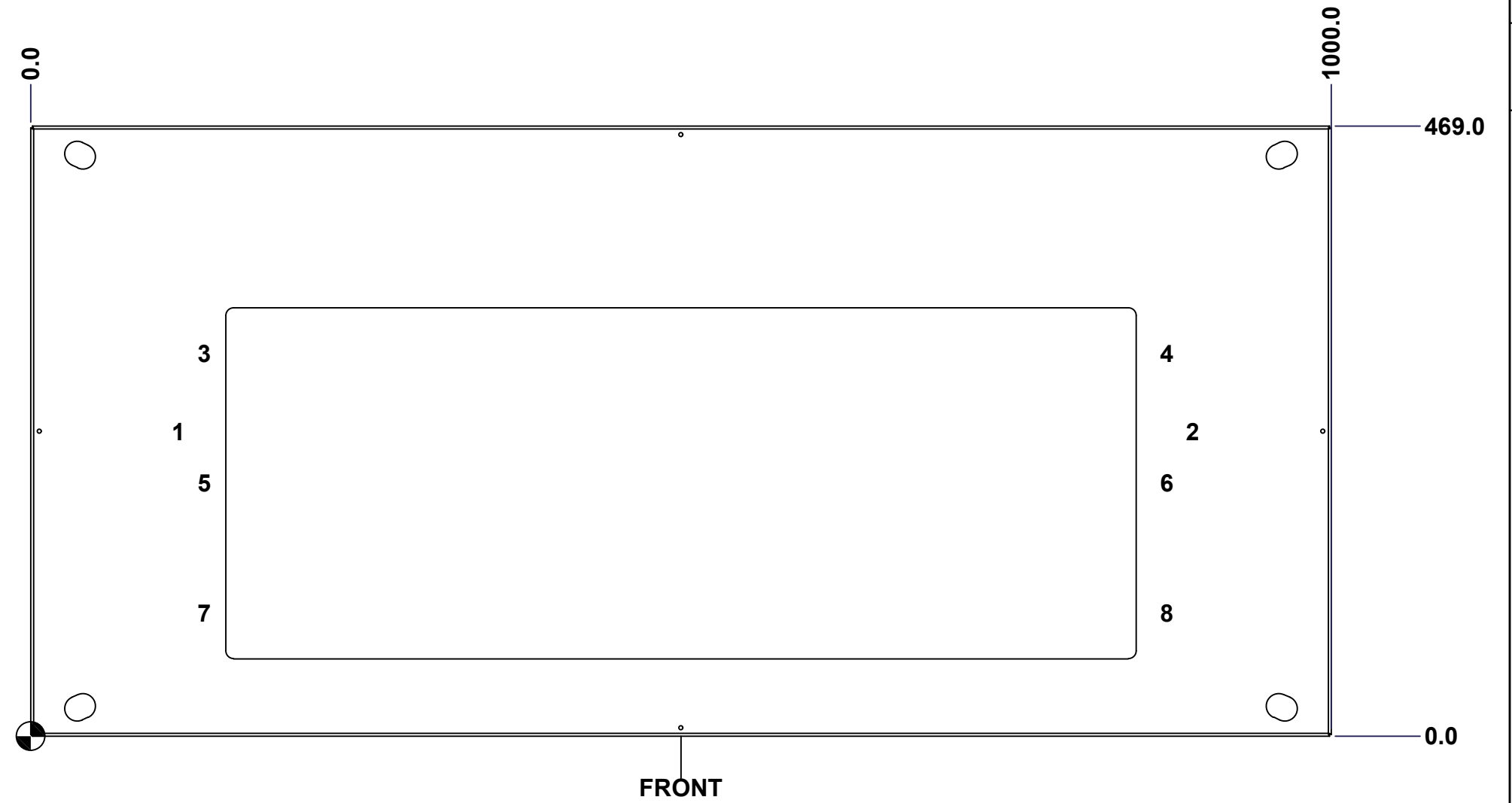

Use bending program path 6500 MX > 6500MXB

	Description	Status
	6500 MXB 1000mm x 500mm Bottom	(NULL)
	Part Number Numéro Pièce	Rev.
	<b>6500MXU201005BT</b>	<b>0</b> / 9
		18

This drawing is confidential and must not be reproduced or used without the consent of EXM

Ce dessin est confidentiel et ne doit pas être reproduit ou utilisé sans le consentement de EXM

No.	Revisions	Date	By/Par

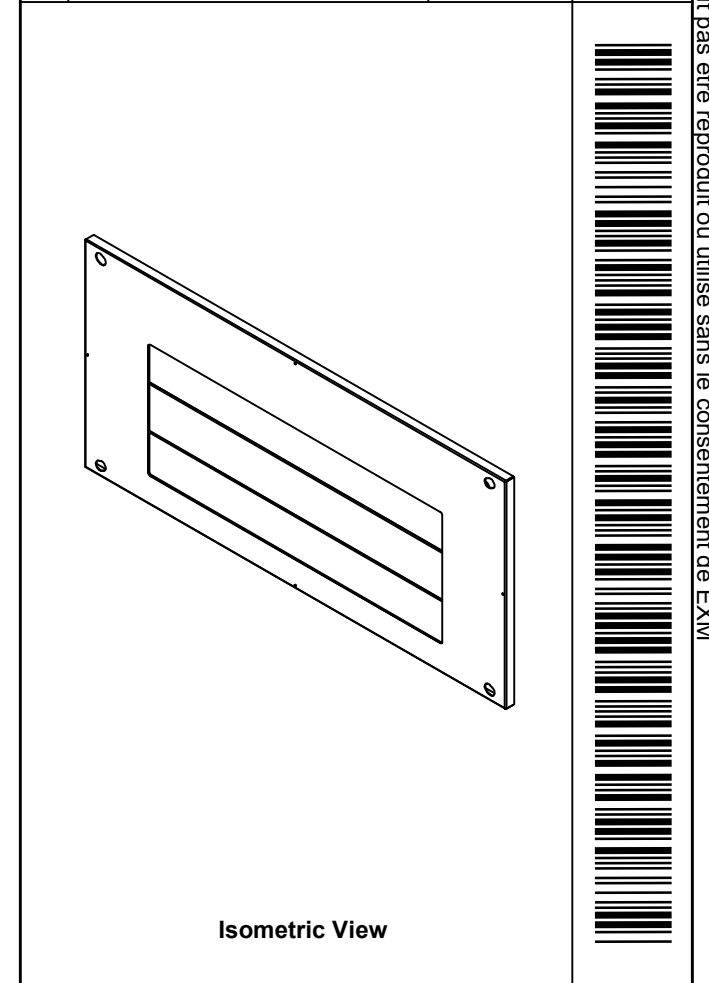

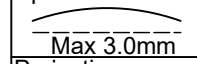
 Tél: (450) 979-4373 Fax: (450) 979-4626 <a href="http://www.exmweb.com">www.exmweb.com</a>		Flatness Aplatissement  Max 3.0mm
Customer Client		Date
Drawn By / Dessiné Par: BoxCad: BoxCad		Date: 10-Mar-15
Material / Matière: 16 Ga Cold Rolled A1008 CS Type B		
Color / Couleur: Iron Grey RAL7011	Finish / Fini: Textured	
Description: 6500 MXB 1000mm x 500mm Bottom		Detail Rev.
Part Number / Numéro Pièce: <b>6500MXU201005BT</b>		Rev. 0 / 10 18

Qty	Part Number	Rev	Description
1	STK-P-03810ST	0	Powder Paint (Iron Grey /Sand Textured)
6	STK-Q-06001	0	Mtrx - Gland Plate M6 Plastic Thumb Nut
8	STK-Q-16055	1	M6 x 18mm Stud (No Paint Cap Required)
3	6500MXU201005GP100-P	0	6500 MXB 1000mm Gland Plate Part (100mm)
1	6500MXU201005BTGPG	0	6500 MXB 1000mm x 500mm Bottom Gland Plate Gasket
1	6500MXU201005BTG	0	6500 MXB 1000mm x 500mm Bottom Gasket
1	6500MXU201005BT-P	0	6500 MXB 1000mm x 500mm Bottom Part
Parts List			

This drawing is confidential and must not be reproduced or used without the consent of EXM

Ce dessin est confidentiel et ne doit pas être reproduit ou utilisé sans le consentement de EXM

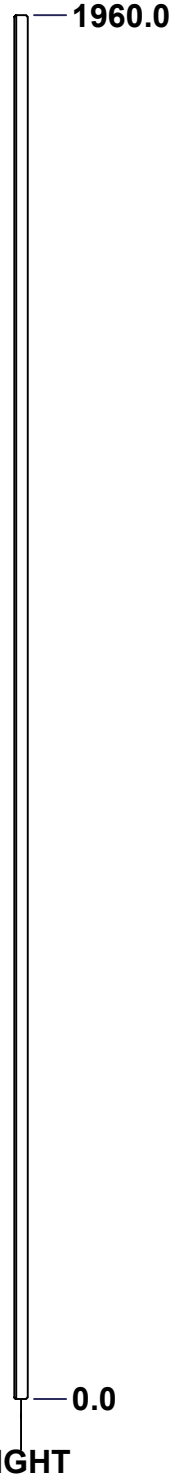
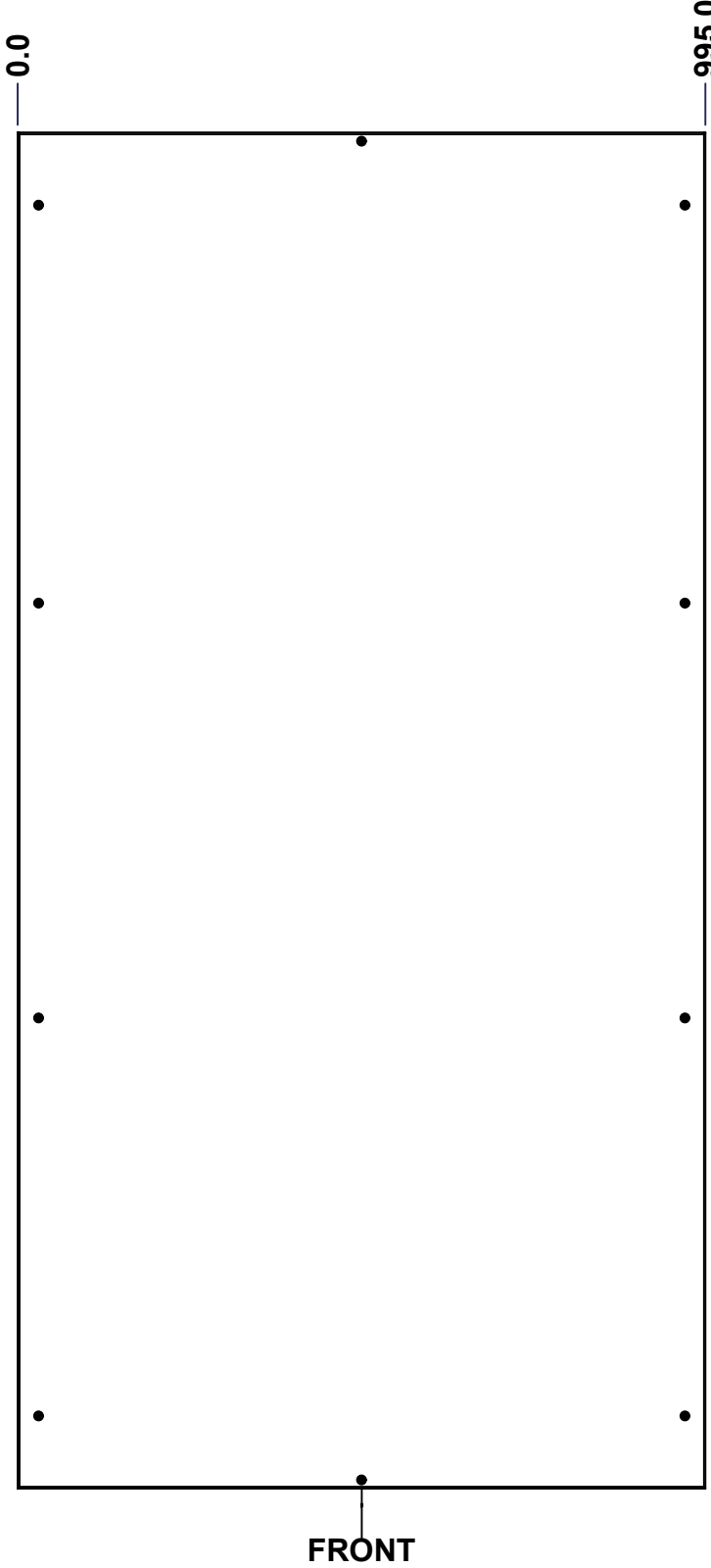
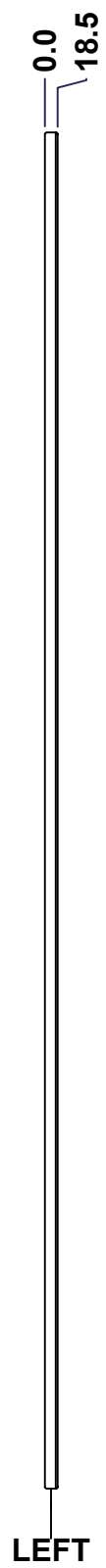
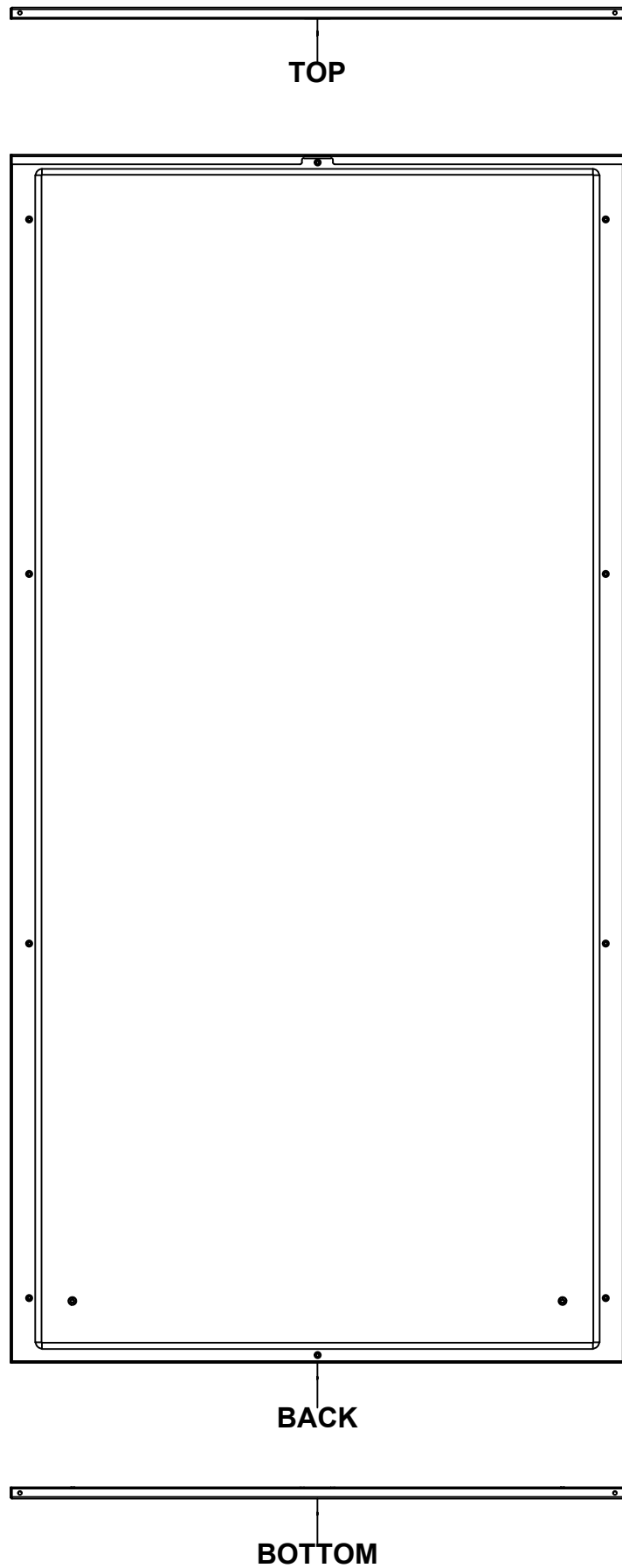

No.	Revisions	Date	By/Par

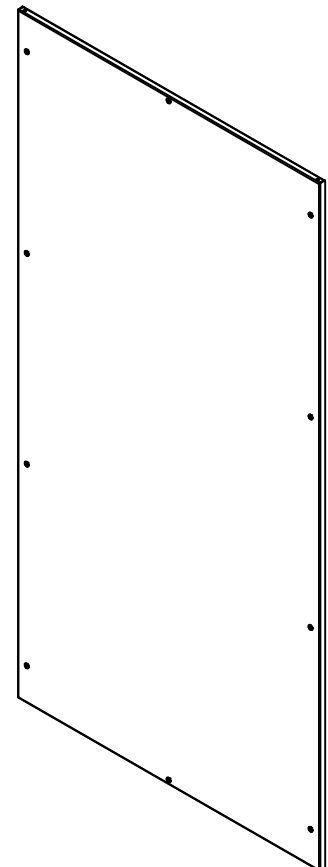

Isometric View

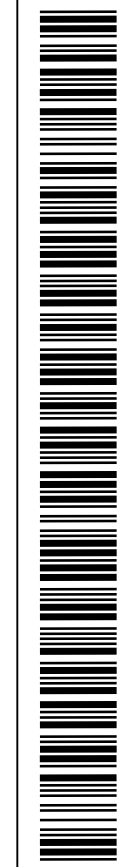

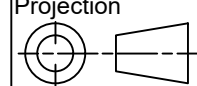
 Tél: (450) 979-4373 Fax: (450) 979-4626 <a href="http://www.exmweb.com">www.exmweb.com</a>		Flatness Aplatissement
		Max 3.0mm
Projection 		Date
Customer Client	BoxCad: BoxCad	Date 10-Mar-15
Material Matière	14 Ga Cold Rolled A1008 CS Type B	
Color Couleur	Light Grey RAL7035	Finish Fini Textured
Description	Detail Rev.	
6500 MXR 2000mm x 1000mm Back		
Part Number Numéro Pièce	Rev. 0	11 / 18
<b>6500MXU201005B</b>		

Use gasket program path 6500 MX > 6500 MXR

SEE BILL OF MATERIAL ON LAST PAGE

This drawing is confidential and must not be reproduced or used without the consent of EXM

Ce dessin est confidentiel et ne doit pas être reproduit ou utilisé sans le consentement de EXM

STANDARD FEATURES ARE NOT LISTED IN THIS HOLE TABLE			
HOLE TABLE - FRONT VIEW (CUSTOM FEATURE ONLY)			
CUT-OUT	XDIM	YDIM	DESCRIPTION
1	100.0	100.0	GND STUD M6 x 16mm (Inside)
2	895.0	100.0	GND STUD M6 x 16mm (Inside)

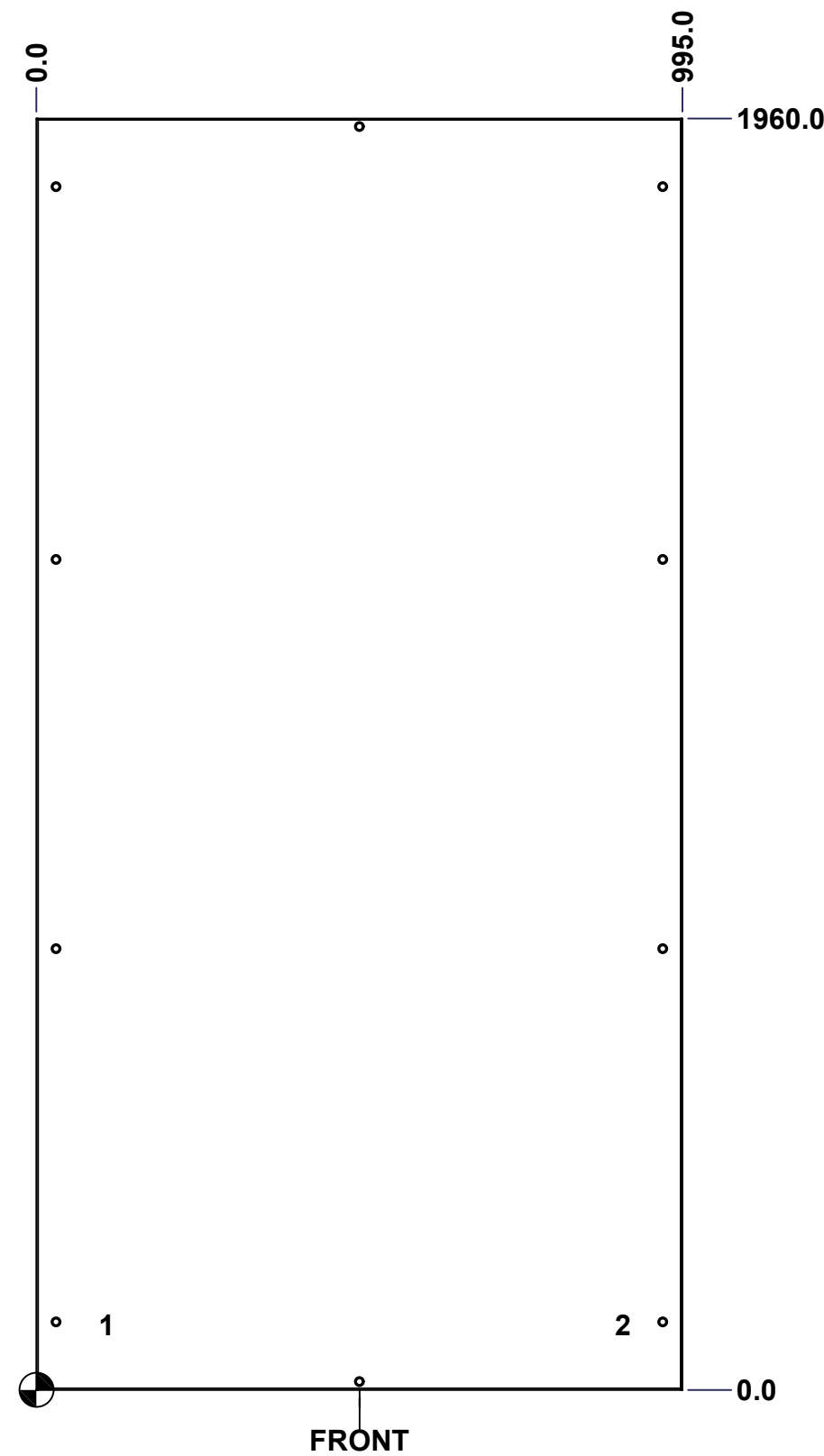

Use bending program path 6500 MX > 6500 MXR

	Description	Status
	6500 MXR 2000mm x 1000mm Back	(NULL)
	Part Number Numéro Pièce	Rev.
	<b>6500MXU201005B</b>	<b>0</b>
		12
		18

This drawing is confidential and must not be reproduced or used without the consent of EXM

Ce dessin est confidentiel et ne doit pas être reproduit ou utilisé sans le consentement de EXM

No.	Revisions	Date	By/Par

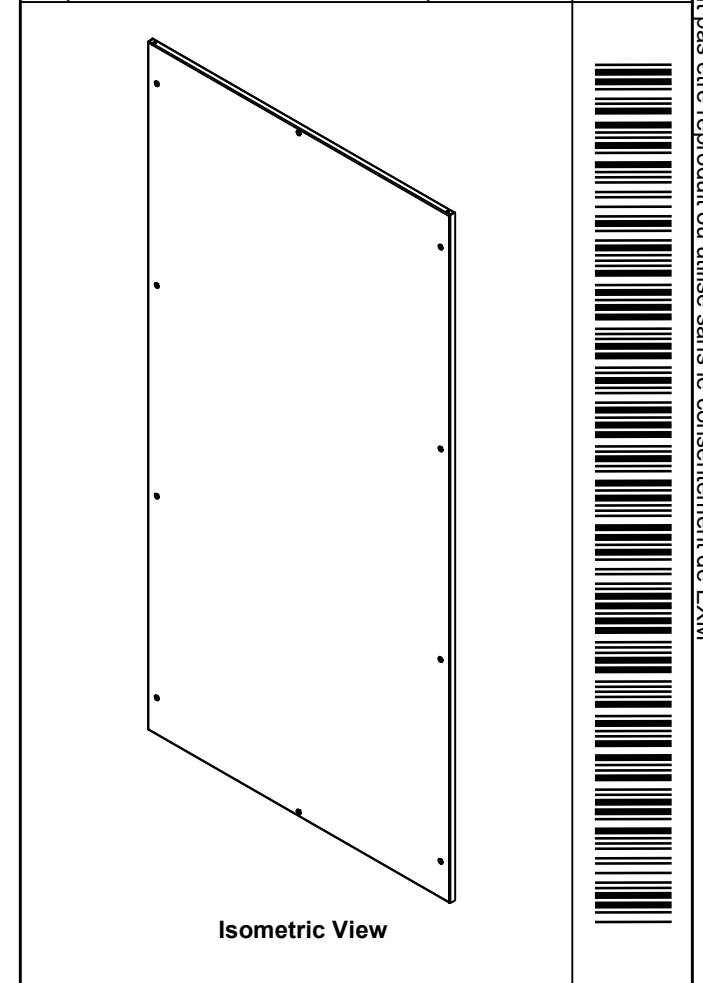

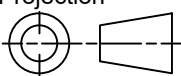
 Tél: (450) 979-4373 Fax: (450) 979-4626 <a href="http://www.exmweb.com">www.exmweb.com</a>		Flatness Aplatissement Max 3.0mm Projection 
Customer Client	Date	
Drawn By / Dessiné Par: BoxCad: BoxCad	Date: 10-Mar-15	
Material / Matière: 14 Ga Cold Rolled A1008 CS Type B		
Color / Couleur: Light Grey RAL7035	Finish / Fini: Textured	
Description: 6500 MXR 2000mm x 1000mm Back		Detail Rev.
Part Number / Numéro Pièce: <b>6500MXU201005B</b>		Rev. 13 / 18

Qty	Part Number	Rev	Description
1	STK-P-03820R	0	Powder Paint (Light Grey / Rough Textured)
1	6500MXU201005BG	0	6500 MXR 2000mm x 1000mm Back Gasket
10	STK-Q-03071	0	M6 x 16mm Machine Screw
2	STK-Q-16080	0	Ground Stud M6 x 16mm Steel
1	6500MXU201005B-P	0	6500 MXR 2000mm x 1000mm Back Part
Parts List			

This drawing is confidential and must not be reproduced or used without the consent of EXM

Ce dessin est confidentiel et ne doit pas être reproduit ou utilisé sans le consentement de EXM

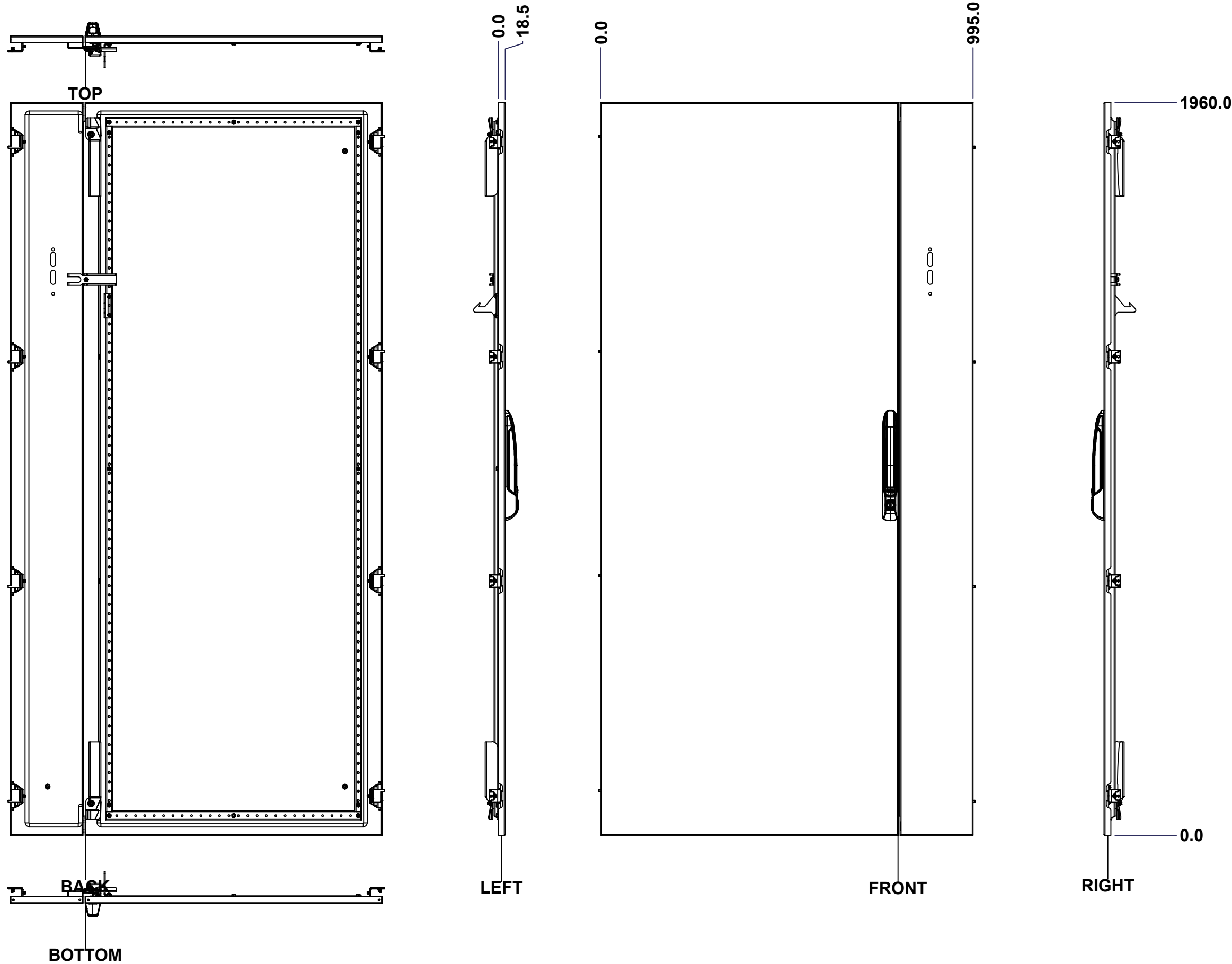

No.	Revisions	Date	By/Par

**Isometric View**

<p>Tél: (450) 979-4373 Fax: (450) 979-4626 <a href="http://www.exmweb.com">www.exmweb.com</a></p>		Flatness Aplatissement
		Max 3.0mm
Customer Client Drawn By / Dessiné Par: BoxCad: BoxCad Material / Matière: 14 Ga Cold Rolled A1008 CS Type B Color / Couleur: Light Grey RAL7035 Finish / Fini: Textured		Projection
Date		Date
Date 10-Mar-15		Date
Description		Detail Rev.
6500 MXDU 2000mm x 1000mm Front		
Part Number / Numéro Pièce		Rev.
6500MXU201005F		14
		0
		18

Use gasket program path 6500 MX > 6500 MXDU

SEE BILL OF MATERIAL ON LAST PAGE

This drawing is confidential and must not be reproduced or used without the consent of EXM

Ce dessin est confidentiel et ne doit pas être reproduit ou utilisé sans le consentement de EXM

**STANDARD FEATURES ARE NOT LISTED IN THIS HOLE TABLE**

**HOLE TABLE - FRONT VIEW (CUSTOM FEATURE ONLY)**

CUT-OUT	XDIM	YDIM	DESCRIPTION
1	100.0	130.0	GND STUD M6 x 16mm (Inside)
2	100.0	1830.0	GND STUD M6 x 16mm (Inside)
3	895.0	130.0	GND STUD M6 x 16mm (Inside)
4	64.5	52.8	STIFF. STUD M6 x 18mm (Inside)
5	64.5	980.0	STIFF. STUD M6 x 18mm (Inside)
6	64.5	1907.2	STIFF. STUD M6 x 18mm (Inside)
7	64.5	1879.0	STIFF. STUD M6 x 18mm (Inside)
8	64.5	81.0	STIFF. STUD M6 x 18mm (Inside)
9	730.5	52.8	STIFF. STUD M6 x 18mm (Inside)
10	730.5	980.0	STIFF. STUD M6 x 18mm (Inside)
11	730.5	1907.2	STIFF. STUD M6 x 18mm (Inside)
12	730.5	1879.0	STIFF. STUD M6 x 18mm (Inside)
13	730.5	81.0	STIFF. STUD M6 x 18mm (Inside)
14	774.0	170.0	LARGE CBAR GUIDE (Inside)
15	774.0	1790.0	LARGE CBAR GUIDE (Inside)
16	774.0	730.0	LARGE CBAR GUIDE (Inside)
17	774.0	1230.0	LARGE CBAR GUIDE (Inside)

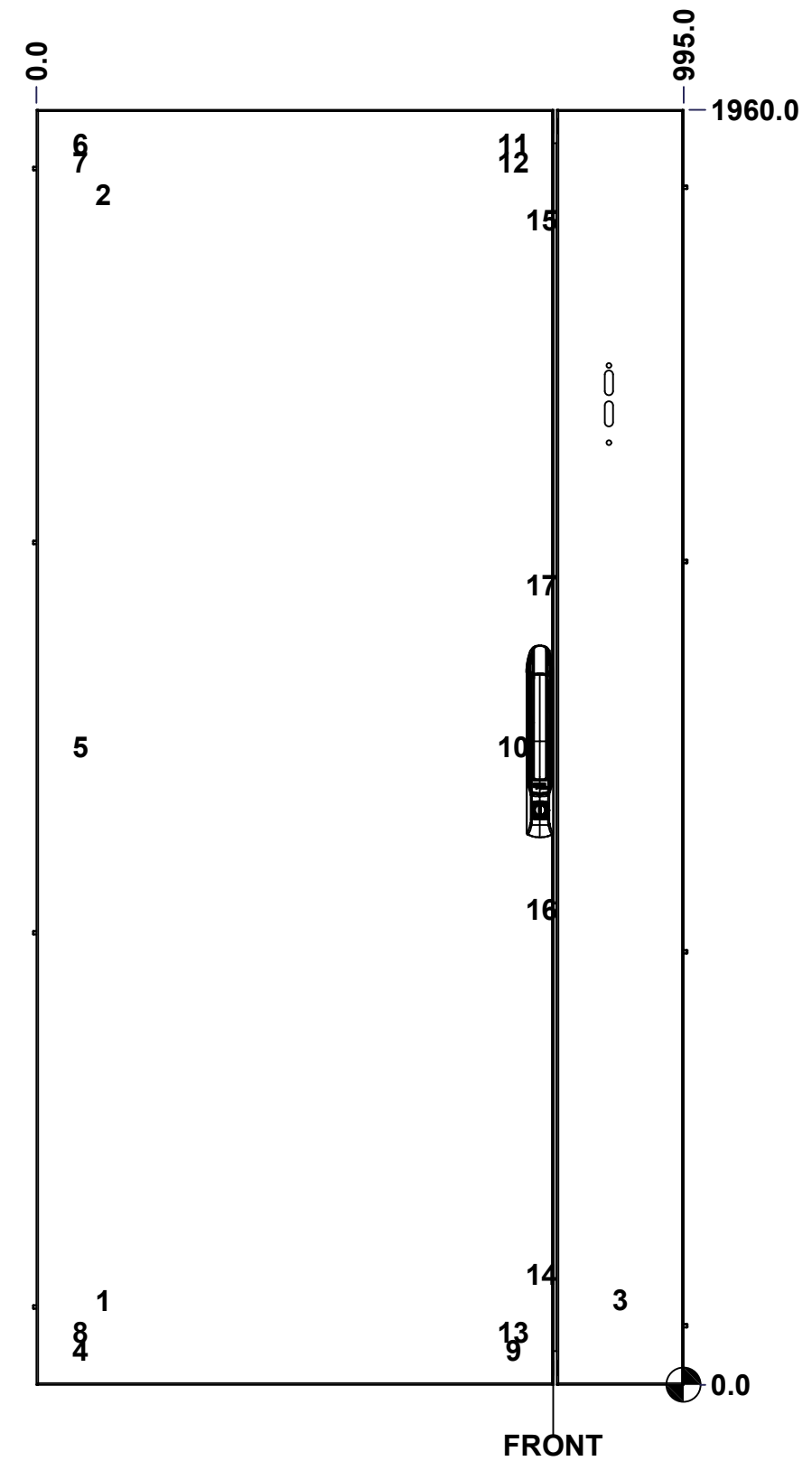

Use bending program path 6500 MX > 6500 MXDU

	Description		Status
	6500 MXDU 2000mm x 1000mm Front		(NULL)
	Part Number Numéro Pièce		Rev.
	<b>6500MXU201005F</b>		<b>0</b> / 15
			18

This drawing is confidential and must not be reproduced or used without the consent of EXM

Ce dessin est confidentiel et ne doit pas être reproduit ou utilisé sans le consentement de EXM

No.	Revisions	Date	By/Par

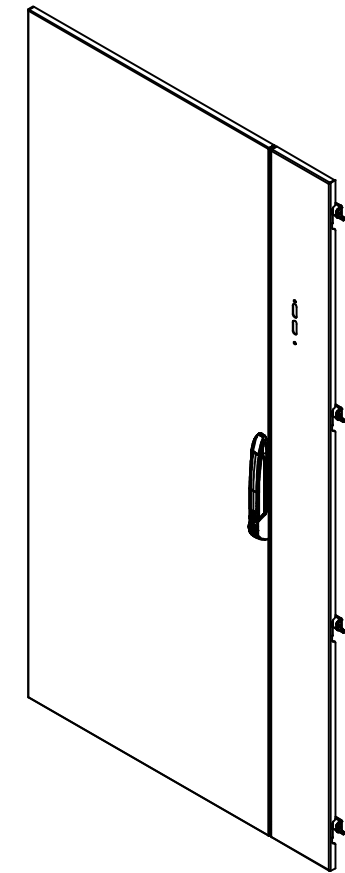

Isometric View



1	STK-P-03820R	0	Powder Paint (Light Grey / Rough Textured)
1	STK-A-51160	0	886PH2-SL - Pull Handle Lock - Assembly
1	STK-Q-45758	1	886 PH2 Pull Handle Bridge Part
4	STK-Q-16410	0	Guide Stud - Large (No Paint Cap Required)
4	STK-A-70586	3	Fixed Double Door Bracket Assembly
1	STK-Q-45662-20	1	6500 MX - Lower Closing Bar 2000mm
1	STK-Q-45661-20	1	6500 MX - Upper Closing Bar 2000mm
1	STK-Q-46650	3	6500 MXDU Disconnect Hook
8	STK-K-06810	7	6500 MX Hinge Assy
2	STK-Q-05020	5	M5 x 8mm Thread Rolling Screw
1	STK-Q-07220	0	M6 Nylon Insert Lock Nut
1	STK-Q-46750	4	6500 MXDU Disconnect Defeater
1	STK-K-10102	3	6500MX - Lock Handle Kit for Flange Door - Right
1	STK-K-10101	3	6500MX - Lock Handle Kit for Flange Door - Left
1	STK-Q-16030	0	Stud M6 x 10mm
2	STK-Q-16050	0	Stud M6 x 18mm
1	6500MXU201005F1G	0	6500 MXDU 2000mm x 1000mm Front Gasket
1	6500MXU201005F1-P	0	6500 MXDU 2000mm x 1000mm Front Part
10	STK-Q-16055	1	M6 x 18mm Stud (No Paint Cap Required)
3	STK-Q-16080	0.1.1	Ground Stud M6 x 16mm Steel
1	6500MXU201005DS1	5	6500 MX 2000mm x 1000mm Door Stiffener
1	6500MXU201005FG	0	6500 MXDU 2000mm x 1000mm Front Gasket
1	6500MXU201005F-P	0	6500 MXDU 2000mm x 1000mm Front Part
Qty	Part Number	Rev.	Description
Parts List			

	Tél: (450) 979-4373 Fax: (450) 979-4626 <a href="http://www.exmweb.com">www.exmweb.com</a>	Flatness Aplatissement
		Max 3.0mm
Projection		
Customer Client	Date	
Drawn By Dessiné Par	BoxCad: BoxCad	Date 10-Mar-15
Material Matière	14 Ga Cold Rolled A1008 CS Type B	
Color Couleur	Light Grey RAL7035	Finish Fini Textured
Description	Detail Rev.	
6500 MXDU 2000mm x 1000mm Front		
Part Number Numéro Pièce	Rev.	16
<b>6500MXU201005F</b>	<b>0</b>	18

This drawing is confidential and must not be reproduced or used without the consent of EXM

Ce dessin est confidentiel et ne doit pas être reproduit ou utilisé sans le consentement de EXM



TOP

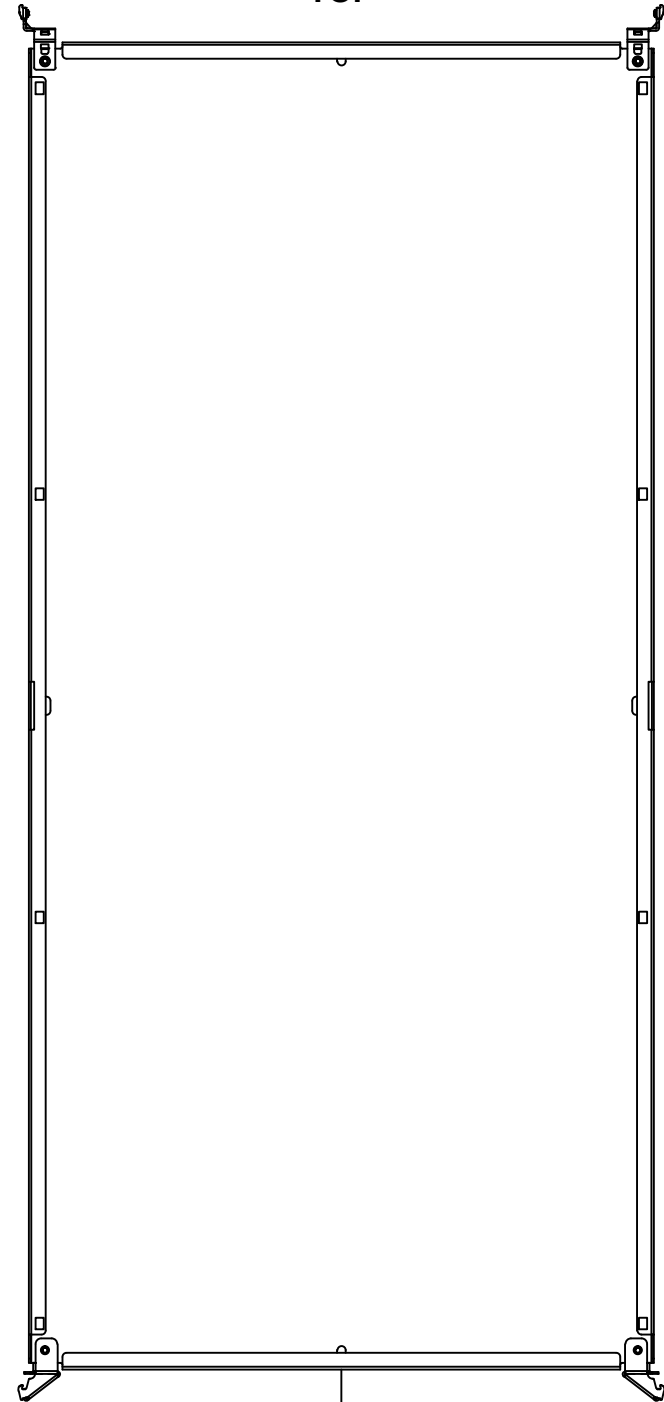

BACK

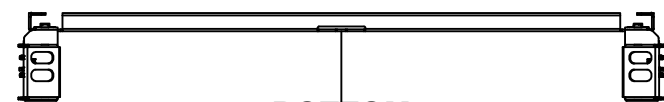

BOTTOM

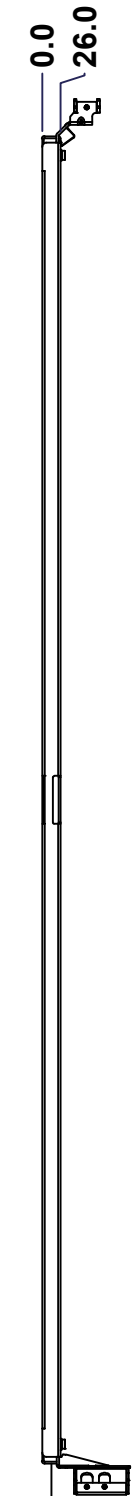

LEFT

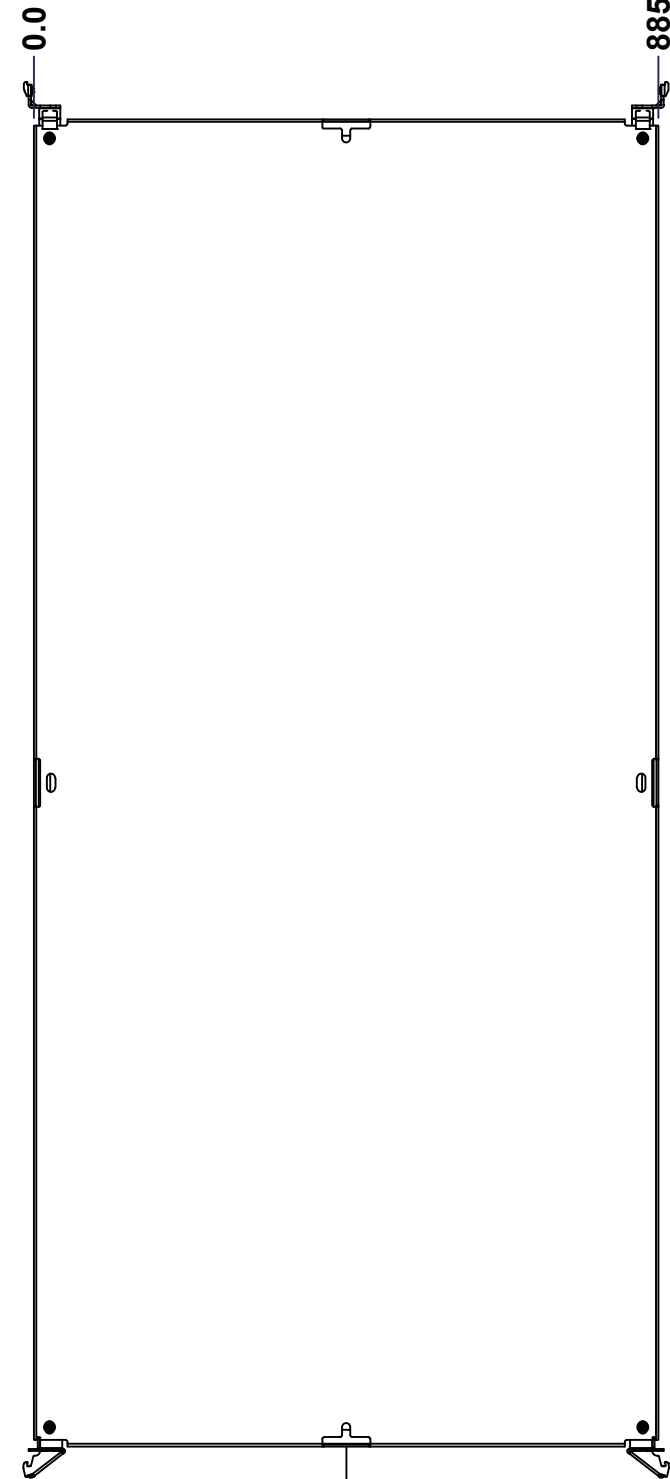

FRONT

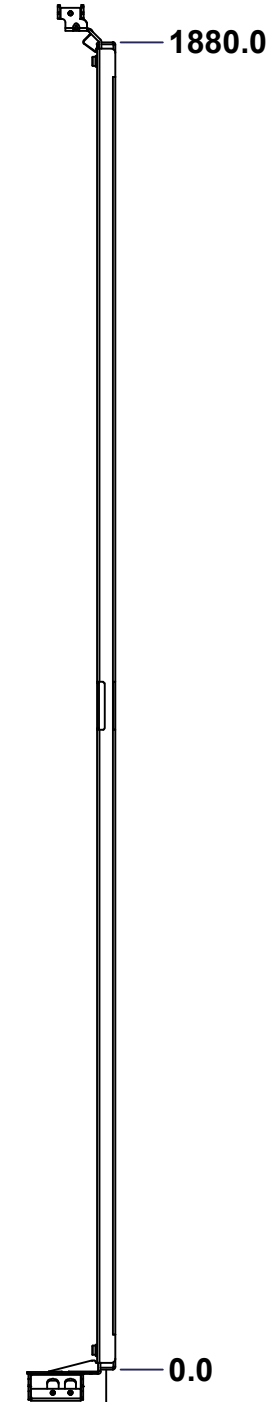

RIGHT

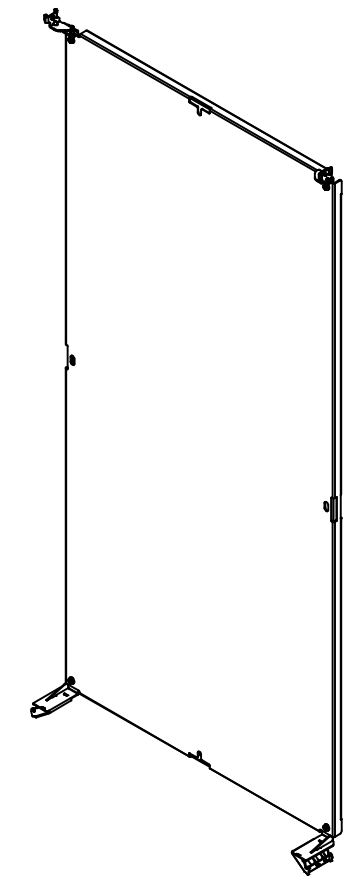

Isometric View

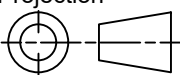

No.	Revisions	Date	By/Par

 Tél: (450) 979-4373 Fax: (450) 979-4626 <a href="http://www.exmweb.com">www.exmweb.com</a>		Flatness Aplatissement Max 3.0mm Projection 
Customer Client	Date	
Drawn By Dessiné Par	BoxCad: BoxCad	Date 10-Mar-15
Material Matière	12 Ga Galvanized (2.5mm)	
Color Couleur	Unpainted	Finish Fini Unpainted
Description	Detail Rev.	
6500 MXM 2000mm x 1000mm Back Inner Panel		
Part Number Numéro Pièce	Rev.	
<b>6500MXU201005BIP</b>	<b>0</b>	17 18

SEE BILL OF MATERIAL ON LAST PAGE

