

This drawing is confidential and must not be reproduced or used without the consent of EXM

Ce dessin est confidentiel et ne doit pas être reproduit ou utilisé sans le consentement de EXM

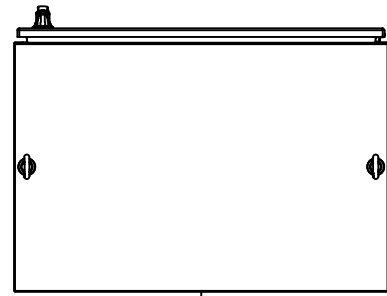

TOP

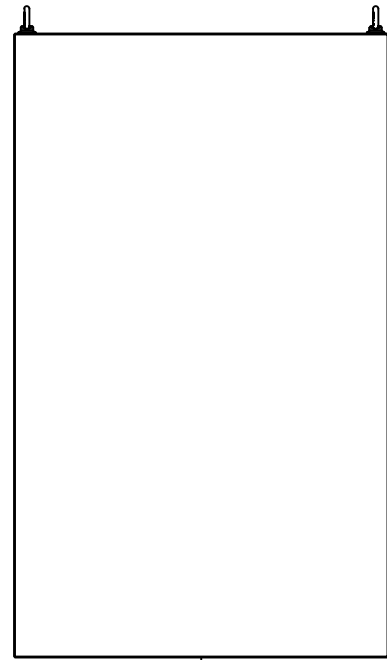

BACK

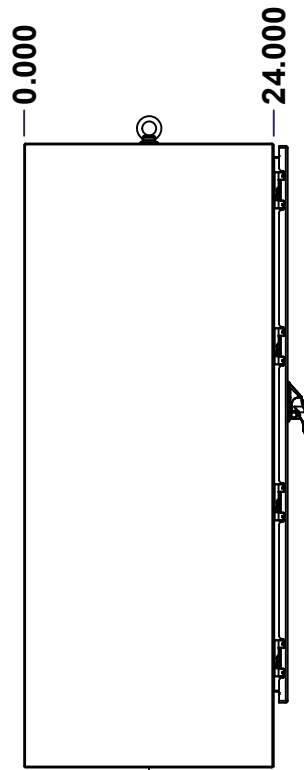

LEFT

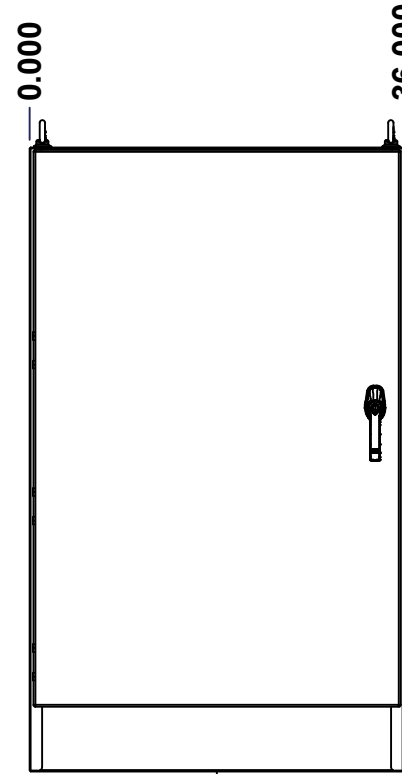

FRONT

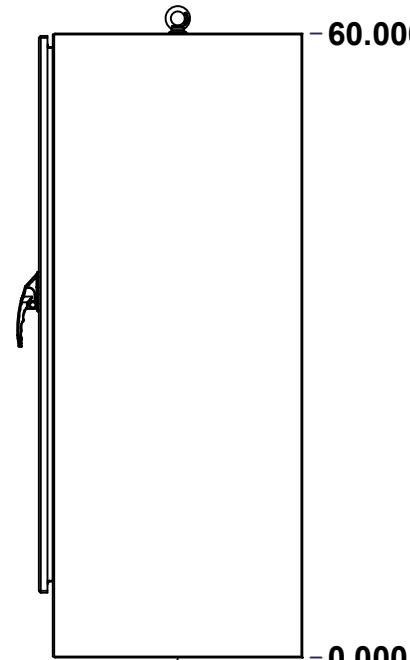

RIGHT

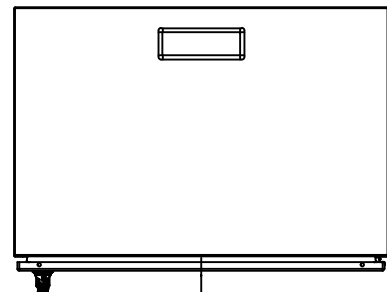

BOTTOM

No.	Revisions	Date	By/Par

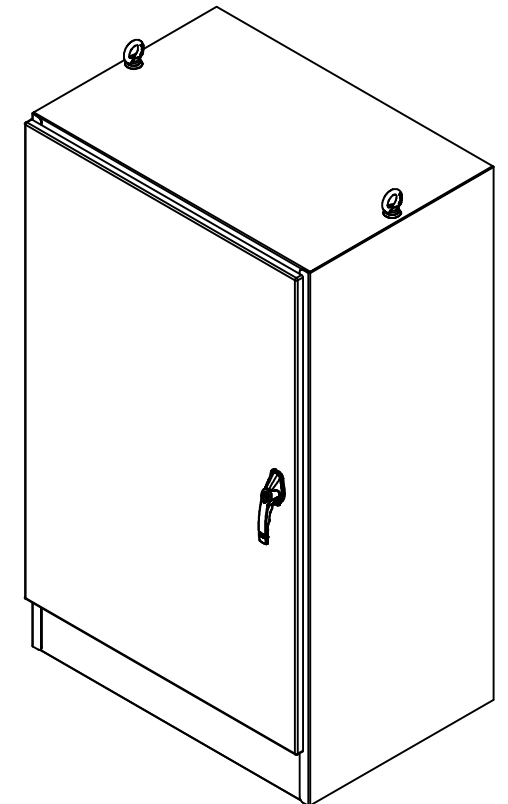

Isometric View



Tél: (450) 979-4373
 Fax: (450) 979-4626
www.exmweb.com

Flatness
 Aplatissement
 Max 3.0mm
 Projection

Customer Client	Date
Drawn By Dessiné Par BoxCad: BoxCad	Date 12-Feb-13
Material Matière 12 Ga Cold Rolled A1008 CS Type B (2.5mm)	
Color Couleur Asa-61 Grey	Finish Fini Smooth
Description 9500 60" x 36" x 24" Assembly	Detail Rev.
Part Number Numéro Pièce 9500603624	Rev. 0

SEE BILL OF MATERIAL ON LAST PAGE

1
12

This drawing is confidential and must not be reproduced or used without the consent of EXM

Ce dessin est confidentiel et ne doit pas être reproduit ou utilisé sans le consentement de EXM

NOTE	
ITEM	DESCRIPTION
1	NEMA 12, 13 Enclosure (IP55)
2	C/W Standard ground studs on box and cover
3	C/W Standard door stiffener
4	W/O Inner panel
5	C/W Standard inner panel mounting struts
6	C/W Eyebolts sold separately (Installed by EXM)
7	C/W Struts installed (Included)

No.	Revisions	Date	By/Par

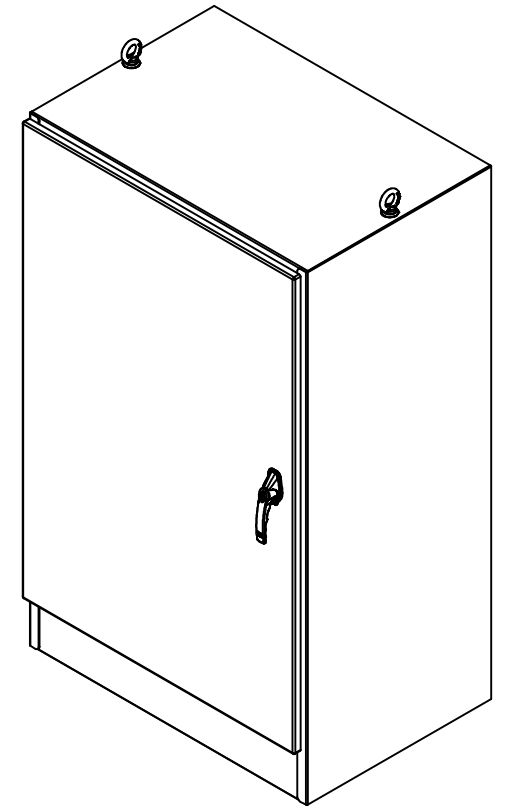

Isometric View



PACKING		
ITEM	QTY	DESCRIPTION
Cardboard sleeve	2	Top and Bottom
Cardboard strip	2	Between back of enclosure and inner panel
Plastic bag	1	To protect cover surface and inside gasket
Cardboard corner	4	To reinforced for the plastic strap tightening
Plastic strap - Black	2	To Squeeze 2 cardboard sleeve together
Packaging label	3	White label with PN
Plastic strap- Green	2	To secure the enclosure to the wood pallet
Wood Pallet	1	2" deeper and 3" larger than enclosure size

Qty	Part Number	Rev	Description
1	9500603624GP	0	9500 Gland Plate
1	880EB14	2	Eye Bolt M14 (Pack of 2)
1	889BPS	0	Inner Panel Strut Mounting Kit
1	9500603624C	0	9500 60" x 36" Cover
1	9500603624B	0	9500 60" x 36" x 24" Body
4	STK-Q-04050-10	8	M6 x 10mm Hexagon Socket Head Machine Screw with Nyseal
Parts List			

		Flatness Aplatissement Max 3.0mm	
Tél: (450) 979-4373 Fax: (450) 979-4626 www.exmweb.com		Projection 	
Customer Client		Date	
Drawn By Dessiné Par BoxCad: BoxCad		Date 12-Feb-13	
Material Matière		12 Ga Cold Rolled A1008 CS Type B (2.5mm)	
Color Couleur	Asa-61 Grey	Finish Fini	Smooth
Description		Detail Rev.	
9500 60" x 36" x 24" Assembly			
Part Number Numéro Pièce		Rev.	2
9500603624		0	12

This drawing is confidential and must not be reproduced or used without the consent of EXM

Ce dessin est confidentiel et ne doit pas être reproduit ou utilisé sans le consentement de EXM

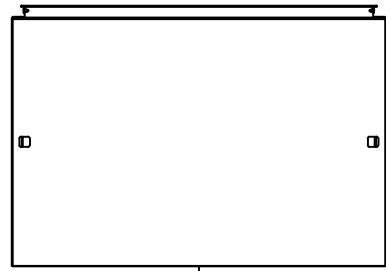

TOP

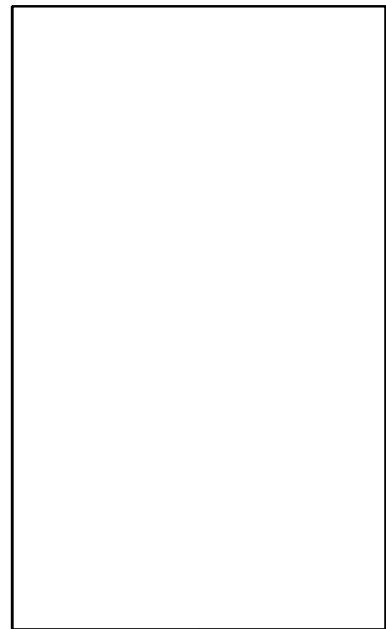

BACK

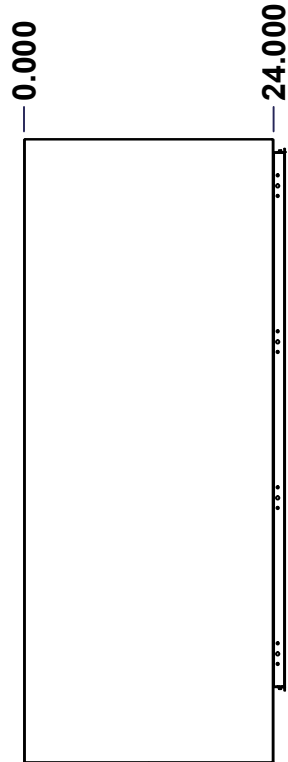

LEFT

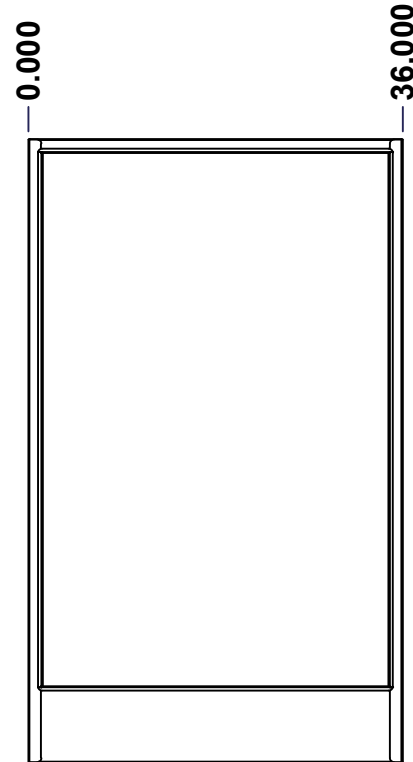

FRONT

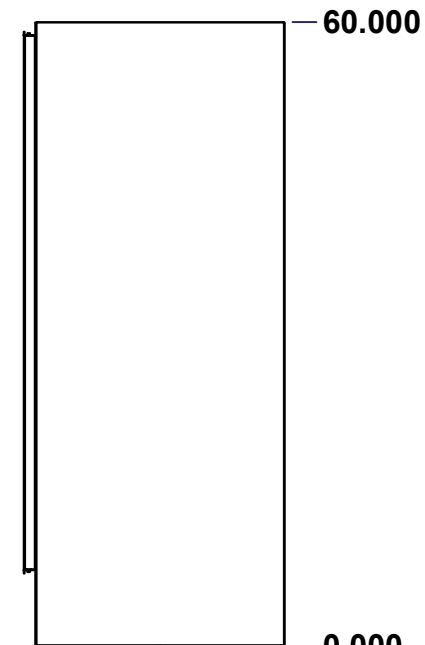

RIGHT

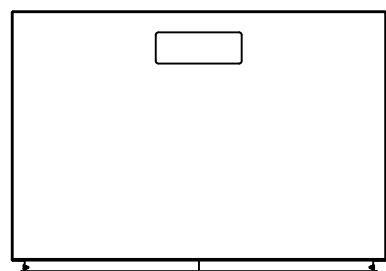

BOTTOM

No.	Revisions	Date	By/Par

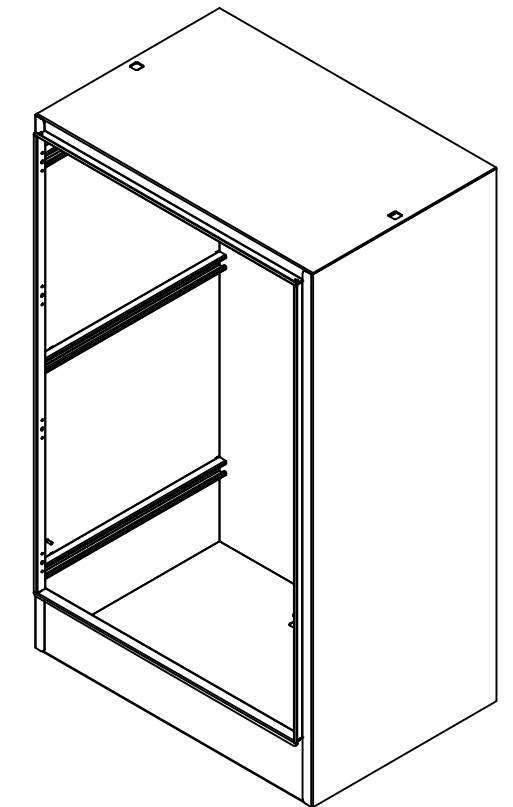

Isometric View

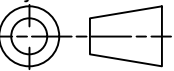

 Tél: (450) 979-4373 Fax: (450) 979-4626 www.exmweb.com		Flatness Aplatissement Max 3.0mm Projection 
Customer Client	Date	
Drawn By Dessiné Par	BoxCad: BoxCad	Date 12-Feb-13
Material Matière	12 Ga Cold Rolled A1008 CS Type B (2.5mm)	
Color Couleur	Asa-61 Grey	Finish Fini Smooth
Description 9500 60" x 36" x 24" Body		Detail Rev.
Part Number Numéro Pièce	Rev. 0	3 12

SEE BILL OF MATERIAL ON LAST PAGE

9500603624B

This drawing is confidential and must not be reproduced or used without the consent of EXM

Ce dessin est confidentiel et ne doit pas être reproduit ou utilisé sans le consentement de EXM

STANDARD FEATURES ARE NOT LISTED IN THIS HOLE TABLE

HOLE TABLE - TOP VIEW (CUSTOM FEATURE ONLY)

CUT-OUT	XDIM	YDIM	DESCRIPTION
1	17.911	19.911	Struts CR400 27.500" (Inside)
2	17.911	20.840	STUDS M6 x 10mm (Inside)
3	31.777	19.911	STUDS M6 x 10mm (Inside)

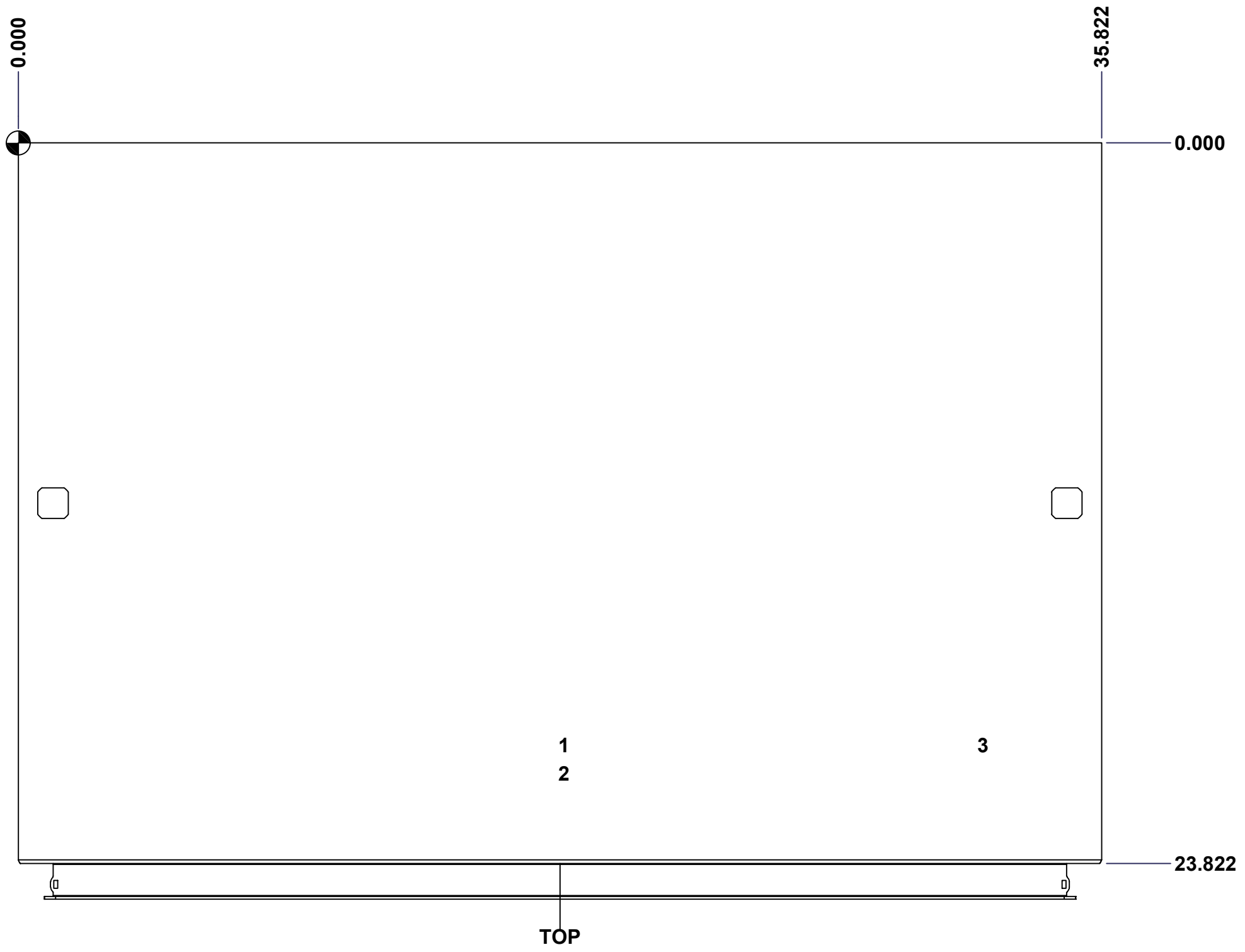

	Description 9500 60" x 36" x 24" Body	Status (NULL)
	Part Number Numéro Pièce 9500603624B	Rev. 4 0

This drawing is confidential and must not be reproduced or used without the consent of EXM

Ce dessin est confidentiel et ne doit pas être reproduit ou utilisé sans le consentement de EXM

STANDARD FEATURES ARE NOT LISTED IN THIS HOLE TABLE

HOLE TABLE - RIGHT VIEW (CUSTOM FEATURE ONLY)

CUT-OUT	XDIM	YDIM	DESCRIPTION
1	7.536	54.107	STUDS M6 x 10mm (Inside)
2	16.286	54.107	STUDS M6 x 10mm (Inside)
3	7.536	7.857	STUDS M6 x 10mm (Inside)
4	16.286	7.857	STUDS M6 x 10mm (Inside)
5	7.536	30.982	STUDS M6 x 10mm (Inside)
6	16.286	30.982	STUDS M6 x 10mm (Inside)

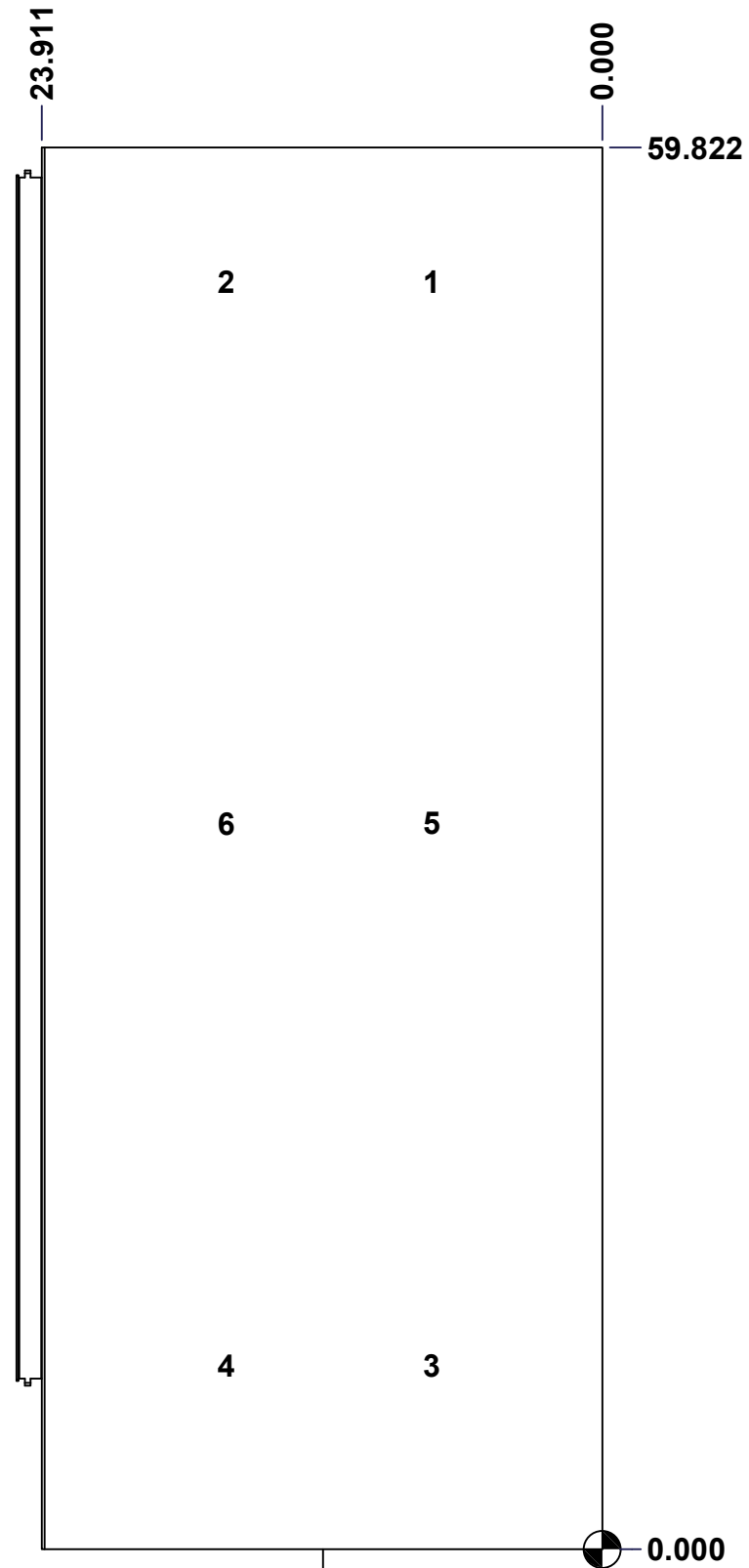

RIGHT

	Description 9500 60" x 36" x 24" Body	Status (NULL)
	Part Number Numéro Pièce 9500603624B	Rev. 5 0

This drawing is confidential and must not be reproduced or used without the consent of EXM

Ce dessin est confidentiel et ne doit pas être reproduit ou utilisé sans le consentement de EXM

STANDARD FEATURES ARE NOT LISTED IN THIS HOLE TABLE			
HOLE TABLE - BOTTOM VIEW (CUSTOM FEATURE ONLY)			
CUT-OUT	XDIM	YDIM	DESCRIPTION
1	13.286	3.411	GP STUD M6 x 16mm (Inside)
2	22.536	3.411	GP STUD M6 x 16mm (Inside)

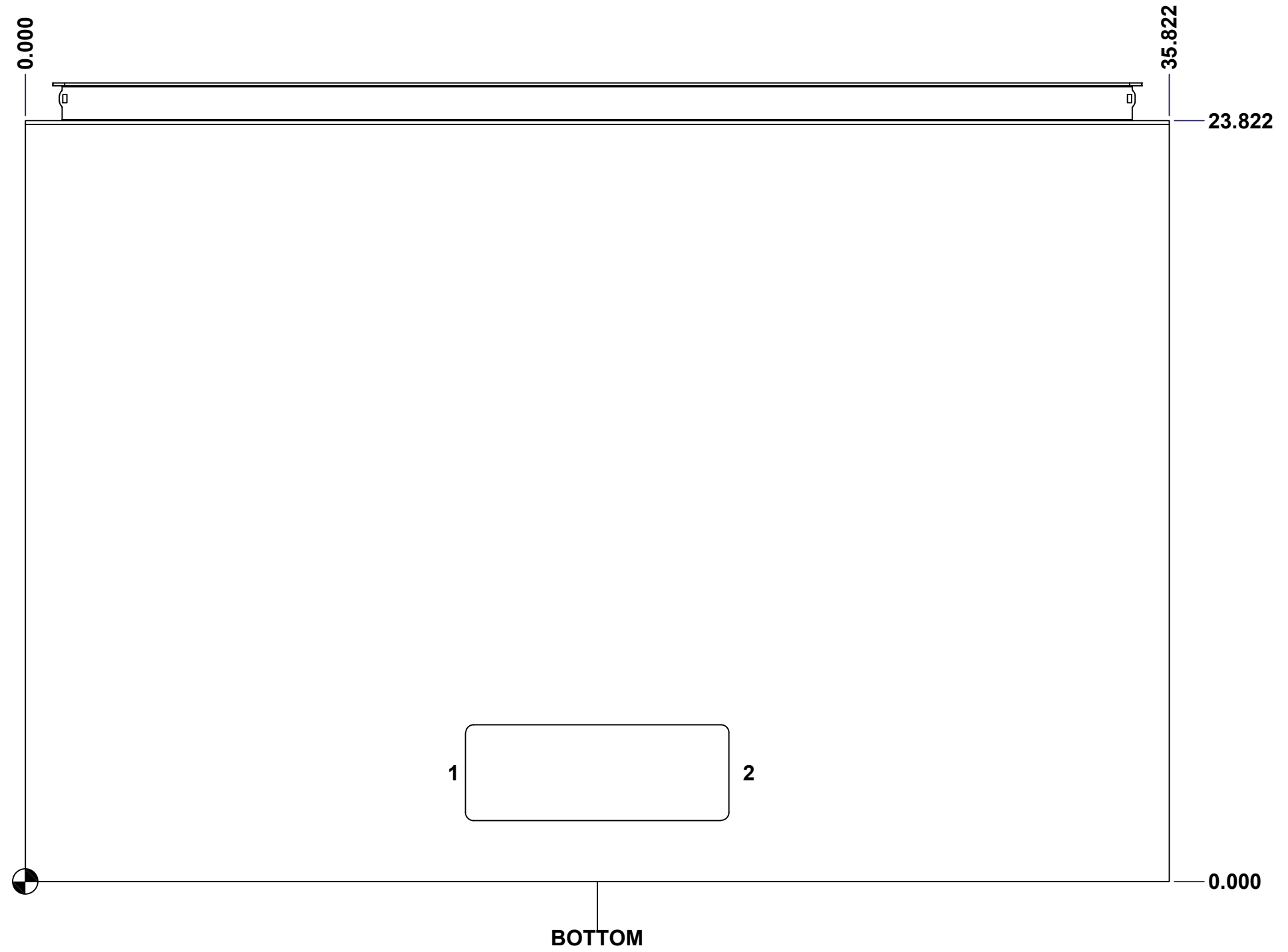

	Description 9500 60" x 36" x 24" Body	Status (NULL)
	Part Number Numéro Pièce 9500603624B	Rev. 6 0

This drawing is confidential and must not be reproduced or used without the consent of EXM

Ce dessin est confidentiel et ne doit pas être reproduit ou utilisé sans le consentement de EXM

STANDARD FEATURES ARE NOT LISTED IN THIS HOLE TABLE

HOLE TABLE - LEFT VIEW (CUSTOM FEATURE ONLY)

CUT-OUT	XDIM	YDIM	DESCRIPTION
1	22.411	11.286	GND STUD M6 x 16mm (Inside)
2	7.536	54.107	STUDS M6 x 10mm (Inside)
3	16.286	54.107	STUDS M6 x 10mm (Inside)
4	7.536	7.857	STUDS M6 x 10mm (Inside)
5	16.286	7.857	STUDS M6 x 10mm (Inside)
6	7.536	30.982	STUDS M6 x 10mm (Inside)
7	16.286	30.982	STUDS M6 x 10mm (Inside)

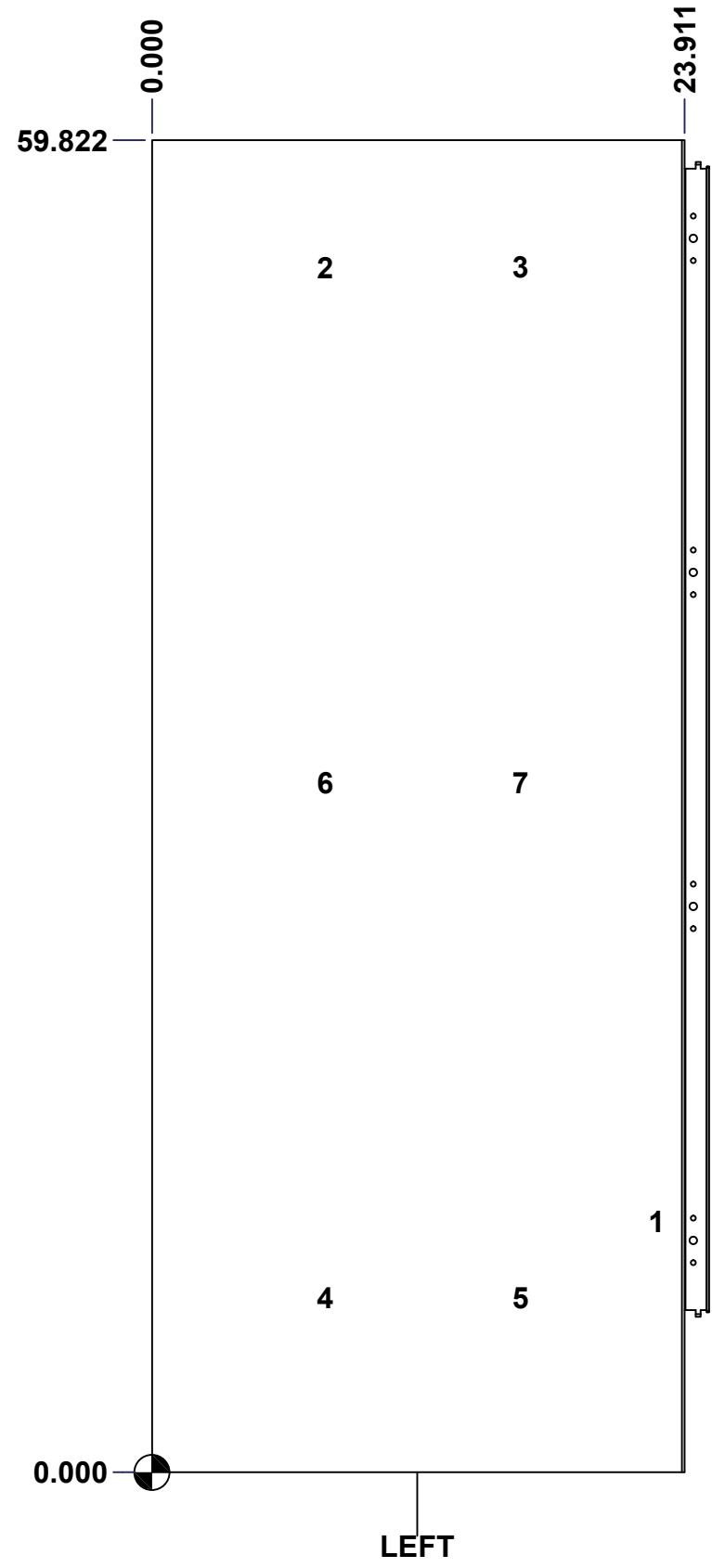

	Description	Status	
	9500 60" x 36" x 24" Body	(NULL)	
	Part Number Numéro Pièce	Rev.	7
	9500603624B	0	12

This drawing is confidential and must not be reproduced or used without the consent of EXM

Ce dessin est confidentiel et ne doit pas être reproduit ou utilisé sans le consentement de EXM

No.	Revisions	Date	By/Par

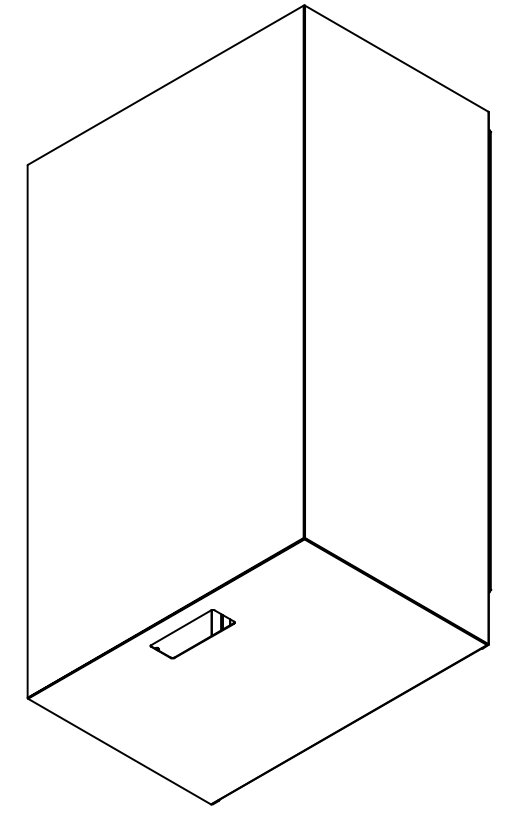

Isometric View

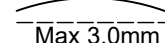
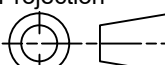

Qty	Part Number	Rev	Description
14	STK-Q-16030	0	Stud M6 x 10mm Steel
1	9500603624_CR400MS_2 7.5	0	Commercial Roll Mild Steel (27.5in long)
2	STK-Q-74910	0	Eyebolt Lifting Angle (15.500")
1	STK-P-02400S	0	Powder Paint (Asa-61 Grey / Smooth)
1	STK-Q-52200-24	2	Sasco Strut S5 (21.500" Long)
5	STK-Q-52250-24	2	Sasco Strut S5 (23.500" Long)
1	9500603624BT-P	0	9500 36" x 24" Bottom Part
1	9500603624T-P	0	9500 36" x 24" Top Part
1	9500603624RS-P	0	9500 60" x 36" Right Part
1	9500603624LS-P	0	9500 60" x 36" Left Part
1	9500603624B-P	0	9500 60" x 36" Back Part
3	STK-Q-16080	0	Ground Stud M6 x 16mm Steel

 Tél: (450) 979-4373 Fax: (450) 979-4626 www.exmweb.com		Flatness Aplatissement  Max 3.0mm
Projection 		Date 12-Feb-13
Customer Client	BoxCad: BoxCad	Date
Drawn By Dessiné Par	BoxCad: BoxCad	Date
Material Matière	12 Ga Cold Rolled A1008 CS Type B (2.5mm)	
Color Couleur	Asa-61 Grey	Finish Fini Smooth
Description	9500 60" x 36" x 24" Body	
Part Number Numéro Pièce	9500603624B	Detail Rev. Rev. 8
		0
		12

Parts List

This drawing is confidential and must not be reproduced or used without the consent of EXM

Ce dessin est confidentiel et ne doit pas être reproduit ou utilisé sans le consentement de EXM



TOP

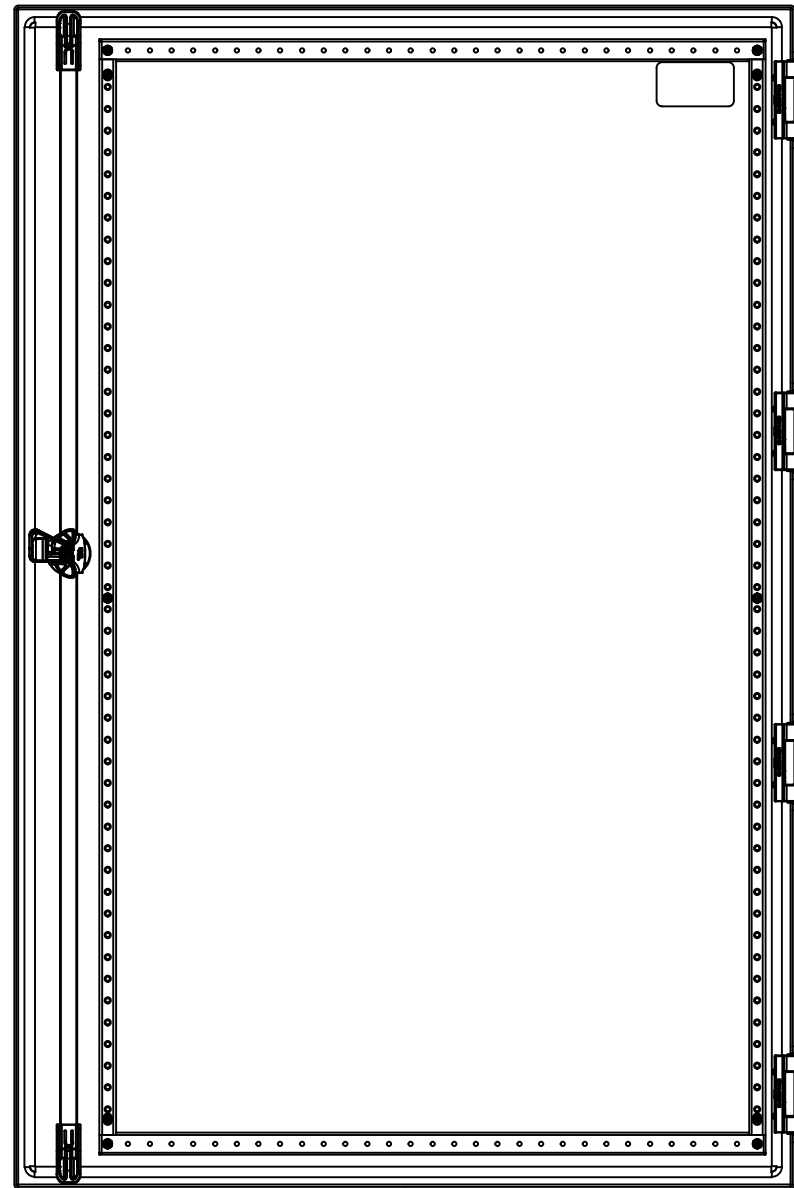

BACK



BOTTOM

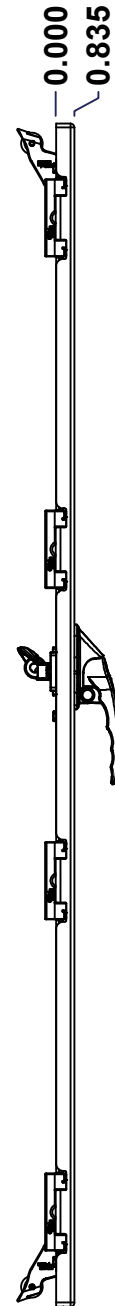

LEFT

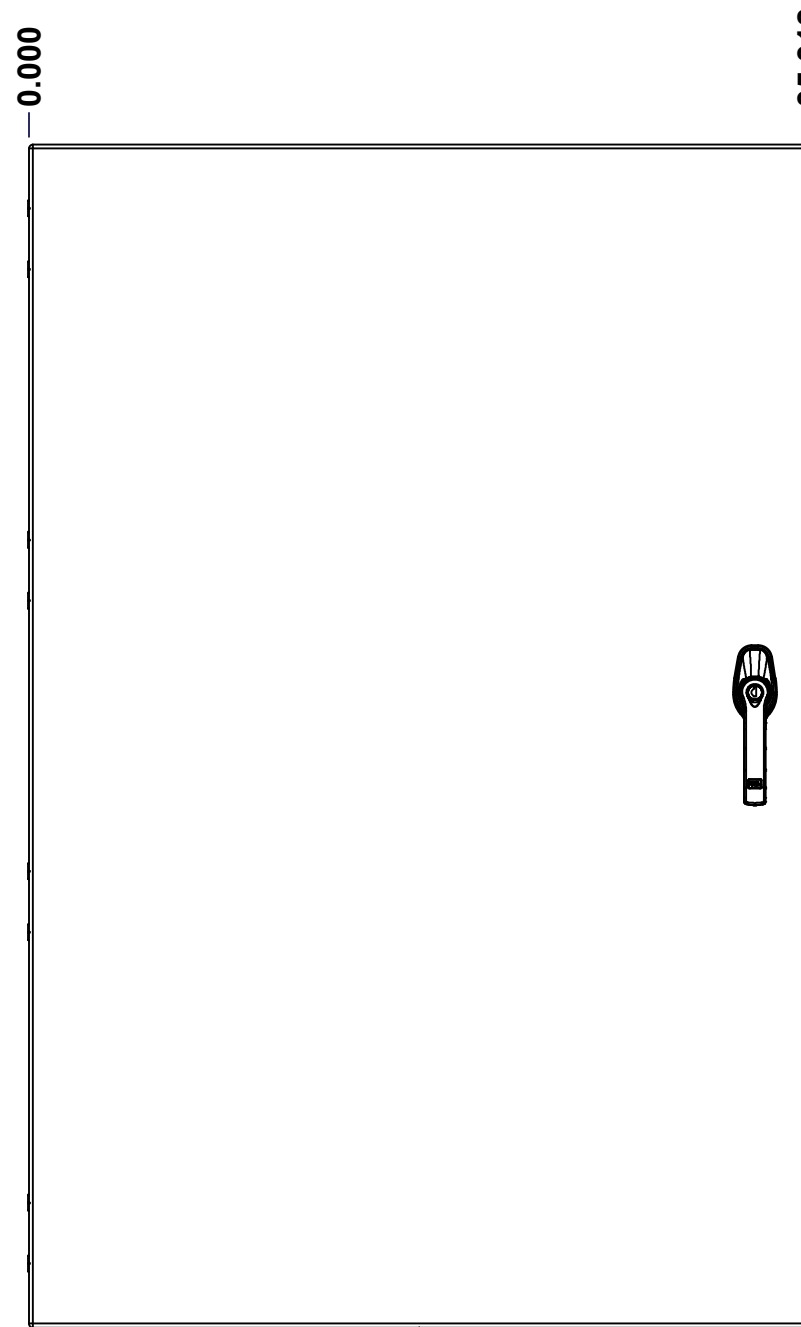

FRONT

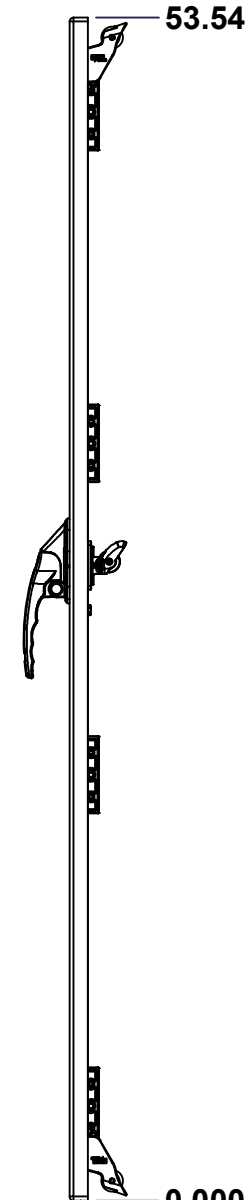

RIGHT

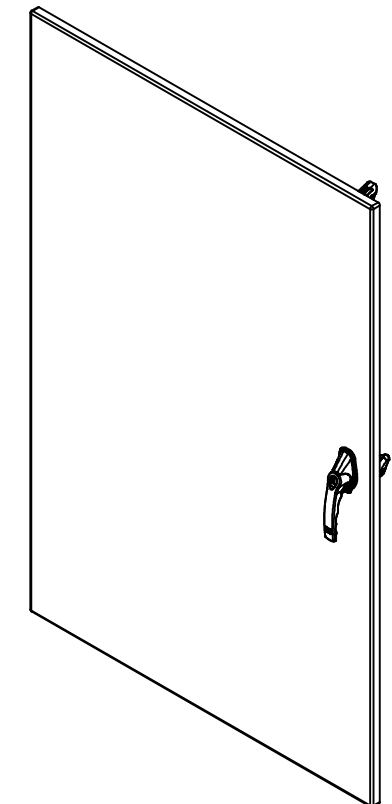

Isometric View

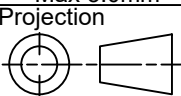

No.	Revisions	Date	By/Par

 Tél: (450) 979-4373 Fax: (450) 979-4626 www.exmweb.com		Flatness Aplatissement Max 3.0mm Projection 
Customer Client	Date	
Drawn By Dessiné Par	BoxCad: BoxCad	Date 12-Feb-13
Material Matière	12 Ga Cold Rolled A1008 CS Type B (2.5mm)	
Color Couleur	Asa-61 Grey	Finish Fini Smooth
Description	Detail Rev.	
9500 60" x 36" Cover		
Part Number Numéro Pièce	Rev. 0	9 12

SEE BILL OF MATERIAL ON LAST PAGE

9500603624C

This drawing is confidential and must not be reproduced or used without the consent of EXM

Ce dessin est confidentiel et ne doit pas être reproduit ou utilisé sans le consentement de EXM

STANDARD FEATURES ARE NOT LISTED IN THIS HOLE TABLE			
HOLE TABLE - FRONT VIEW (CUSTOM FEATURE ONLY)			
CUT-OUT	XDIM	YDIM	DESCRIPTION
1	1.685	2.028	STUD M6 x 18mm (Inside)
2	1.685	26.722	STUD M6 x 18mm (Inside)
3	1.685	51.521	STUD M6 x 18mm (Inside)
4	31.092	2.028	STUD M6 x 18mm (Inside)
5	31.092	26.722	STUD M6 x 18mm (Inside)
6	31.092	51.521	STUD M6 x 18mm (Inside)
7	1.685	3.139	STUD M6 x 18mm (Inside)
8	1.685	50.409	STUD M6 x 18mm (Inside)
9	31.092	3.139	STUD M6 x 18mm (Inside)
10	31.092	50.409	STUD M6 x 18mm (Inside)
11	32.858	6.118	LARGE CBAR GUIDE (Inside)
12	32.858	47.430	LARGE CBAR GUIDE (Inside)
-----	-----	-----	-----
13	32.858	28.743	HANDLE 885 ESL2A-APHK @ 0.0°

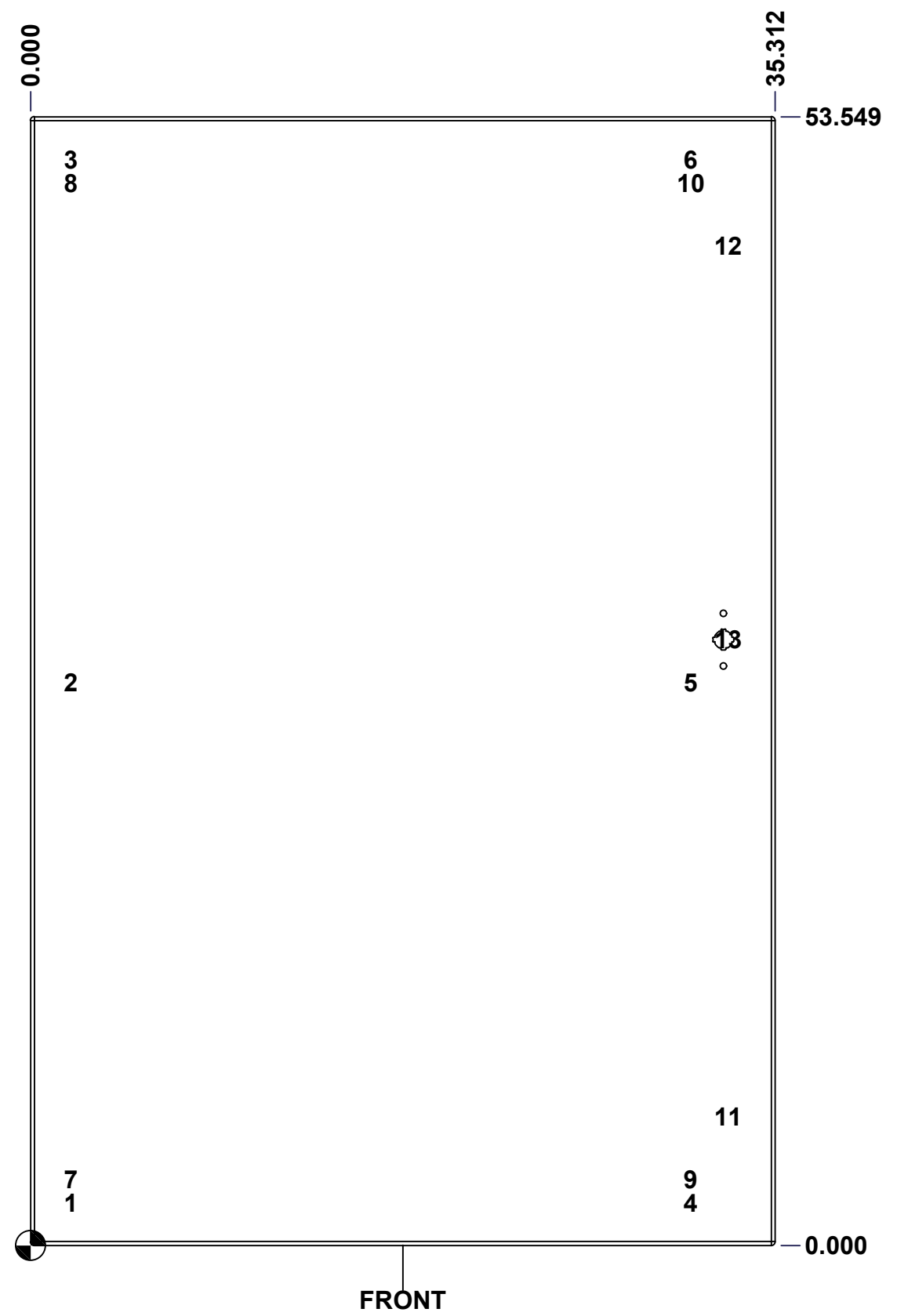

	Description	Status
	9500 60" x 36" Cover	(NULL)
	Part Number Numéro Pièce	Rev.
	9500603624C	0 / 10
		12

This drawing is confidential and must not be reproduced or used without the consent of EXM

Ce dessin est confidentiel et ne doit pas être reproduit ou utilisé sans le consentement de EXM

No.	Revisions	Date	By/Par

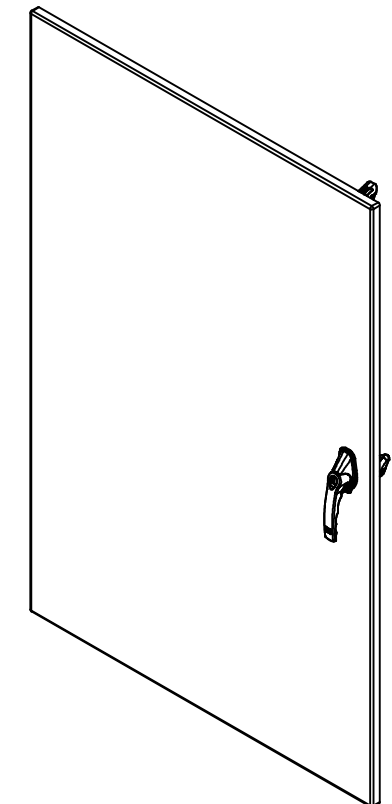

Isometric View

1	STK-Q-47561	0	9500 Lower Closing Bar 60" (cam)
1	STK-Q-47551	0	9500 Upper Closing Bar 60" (cam)
2	STK-Q-07220	1	M6 Nylon Insert Lock Nut
1	STK-A-50538	3	9500 Handle Cam Assembly (Right Side, Grip 36mm)
1	STK-Q-90051	3	5412 ES - Handle Cam Spacer
1	885ESL2A-APHK	7	885 ESL2A-APHK - Zinc Die Cast L-Handle Padlockable Assy
1	STK-P-02400S	0	Powder Paint (Asa-61 Grey / Smooth)
1	STK-S-00100	0	3.5" x 2" Silver Milar Flexcon Sticker
1	STK-K-10820	3	9500 - Door Stiffener Assembly
2	STK-Q-16410	0	Guide Stud - Largel (No Paint Cap Required)
10	STK-Q-16055	1	M6 x 18mm Stud (No Paint Cap Required)
1	9500603624G	0	9500 60" x 36" Cover Gasket
1	9500603624C-P	0	9500 60" x 36" Cover Part
2	STK-A-90025	0	9500 - Cabinet Closing Bar End (Large)
4	STK-K-09860	7	Cabinet Hinge with Captive Pins

QTY	Part Number	Rev	Description
Parts List			

Tél: (450) 979-4373 Fax: (450) 979-4626 www.exmweb.com	Flatness Aplatissement	Max 3.0mm
	Projection	
Customer Client	Date	
Drawn By Dessiné Par	BoxCad: BoxCad	Date 12-Feb-13
Material Matière	12 Ga Cold Rolled A1008 CS Type B (2.5mm)	
Color Couleur	Asa-61 Grey	Finish Fini Smooth
Description	9500 60" x 36" Cover	
Part Number Numéro Pièce	Rev. 0	11 12
9500603624C		

All knockouts are actual size / Les disques défonçables sont grandeur réel
 All dimensions are before paint / Toutes les dimensions sont avant peinture

This drawing is confidential and must not be reproduced or used without the consent of EXM

Ce dessin est confidentiel et ne doit pas être reproduit ou utilisé sans le consentement de EXM

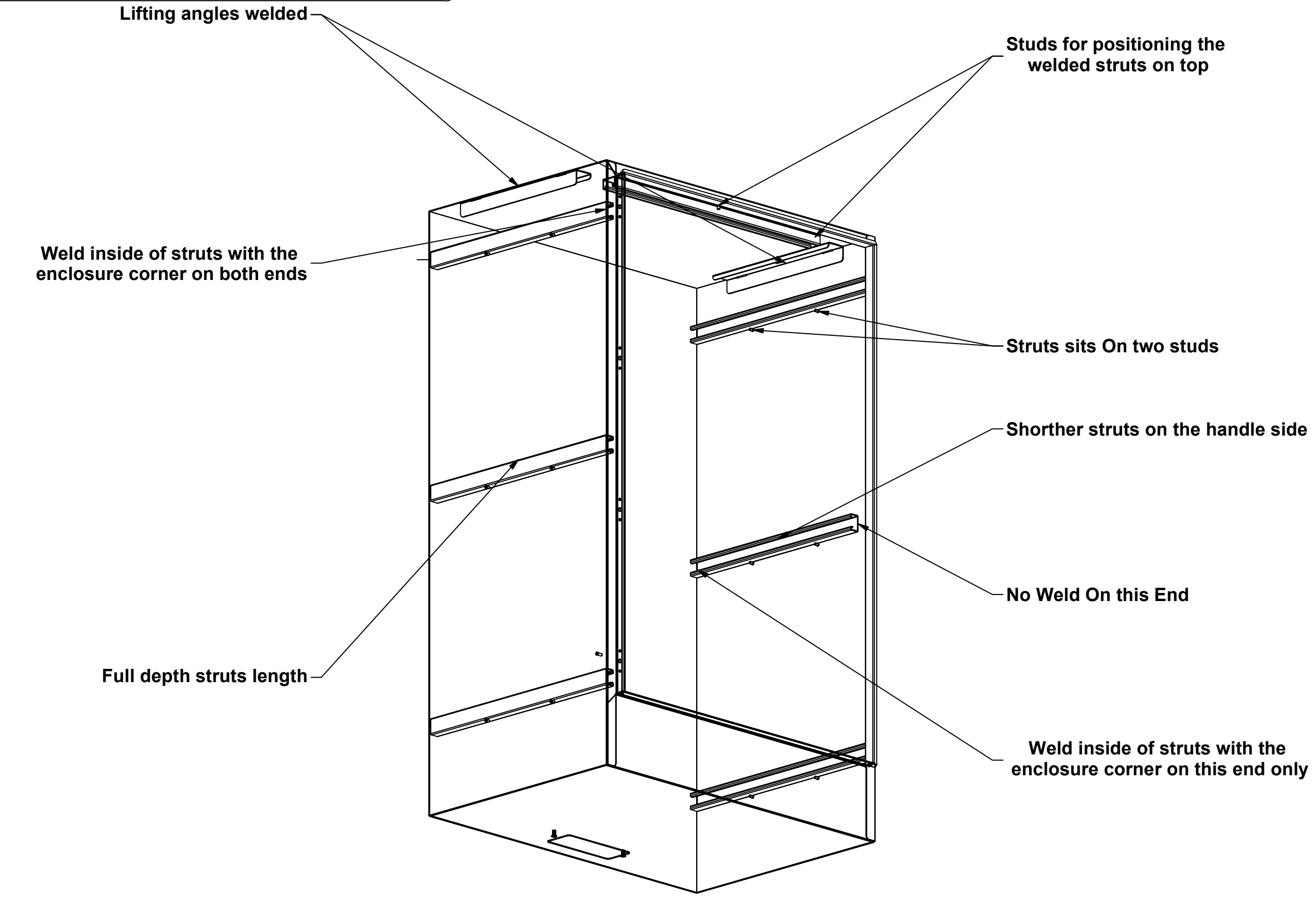

No.	Revisions	Date	By/Par

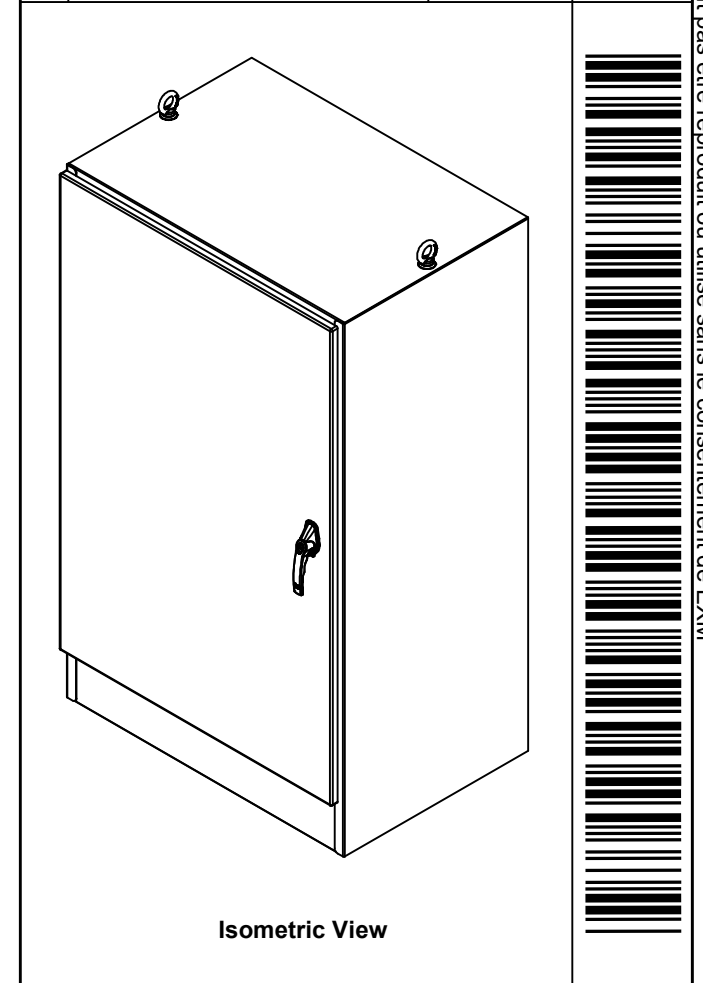

 Tél: (450) 979-4373 Fax: (450) 979-4626 www.exmweb.com		Flatness Aplatissement
		Max 3.0mm
Customer Client		Date
Drawn By Dessiné Par BoxCad		Date 11-Aug-05
Material Matière 12 Ga Cold Rolled A1008 CS Type B (2.5mm)		
Color Couleur Asa-61 Grey	Finish Fini Smooth	
Description 9500 60" x 36" x 24" Assembly		Detail Rev.
Part Number Numéro Pièce 9500 Welding Details		Rev. 12 0 12