

This drawing is confidential and must not be reproduced or used without the consent of EXM

Ce dessin est confidentiel et ne doit pas être reproduit ou utilisé sans le consentement de EXM

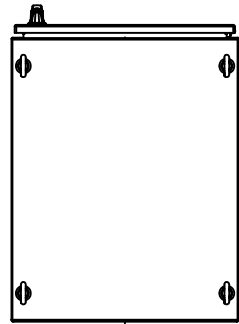

TOP

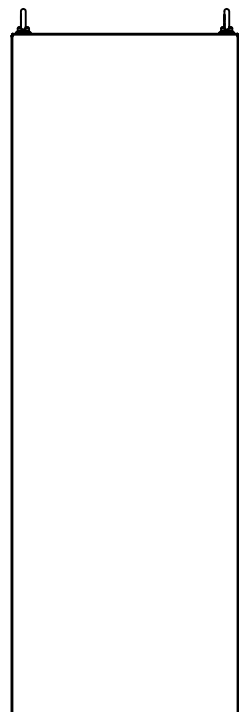

BACK

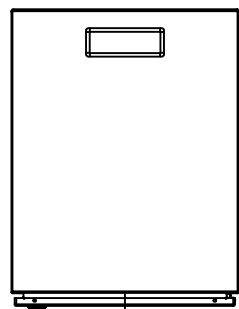

BOTTOM

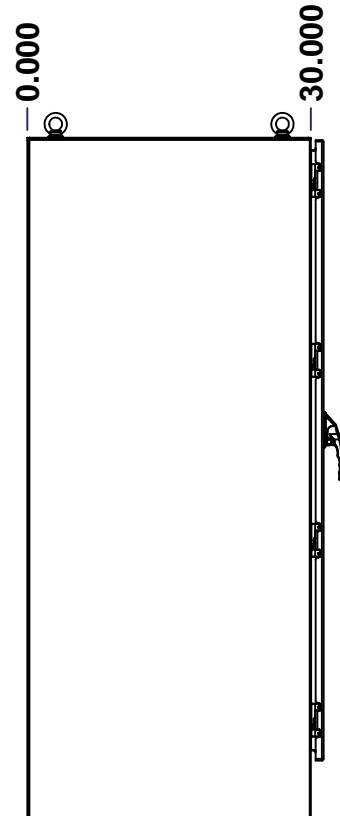

LEFT

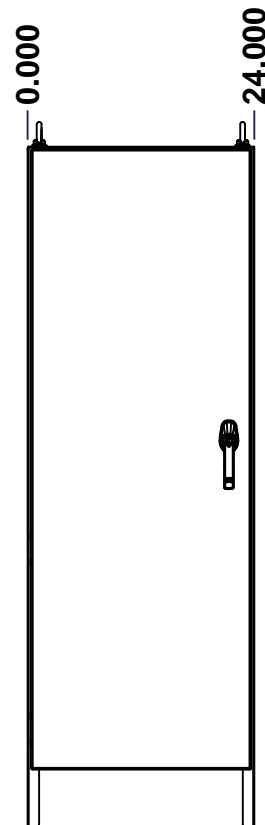

FRONT

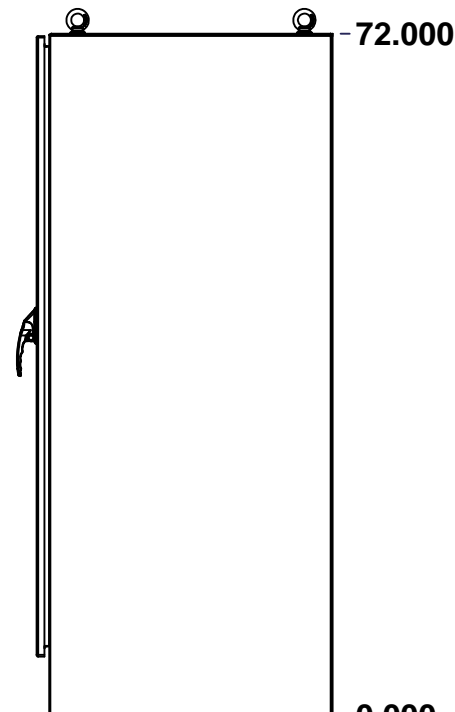

RIGHT

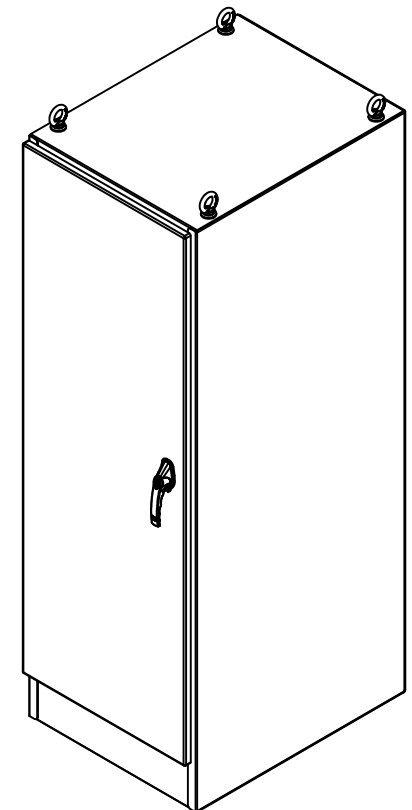

Isometric View

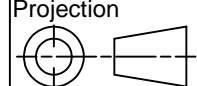

| No. | Revisions | Date | By/Par |
|-----|-----------|------|--------|
| | | | |
| | | | |
| | | | |
| | | | |
| | | | |

| | | |
|--|---|---|
|  Tél: (450) 979-4373 Fax: (450) 979-4626 www.exmweb.com | | Flatness Aplatissement Max 3.0mm Projection  |
| Customer Client | Date | |
| Drawn By Dessiné Par | BoxCad: BoxCad | Date 09-Dec-21 |
| Material Matière | 12 Ga Cold Rolled A1008 CS Type B (2.5mm) | |
| Color Couleur | Asa-61 Grey | Finish Fini Smooth |
| Description | Detail Rev. | |
| 9500 72" x 24" x 30" Assembly | | |
| Part Number Numéro Pièce | Rev. 0 | 1 2 |
| 9500ST722430 | | |

SEE BILL OF MATERIAL ON LAST PAGE

This drawing is confidential and must not be reproduced or used without the consent of EXM

Ce dessin est confidentiel et ne doit pas être reproduit ou utilisé sans le consentement de EXM

| NOTE | |
|------|--|
| ITEM | DESCRIPTION |
| 1 | NEMA 12/13 Enclosure |
| 2 | C/W Standard ground studs on box and cover |
| 3 | C/W Standard door stiffener |
| 4 | W/O Inner panel |
| 5 | C/W Standard inner panel mounting studs |
| 6 | C/W Eyebolts |
| 7 | C/W Struts installed (Included) |

| No. | Revisions | Date | By/Par |
|-----|-----------|------|--------|
| | | | |
| | | | |
| | | | |
| | | | |
| | | | |
| | | | |

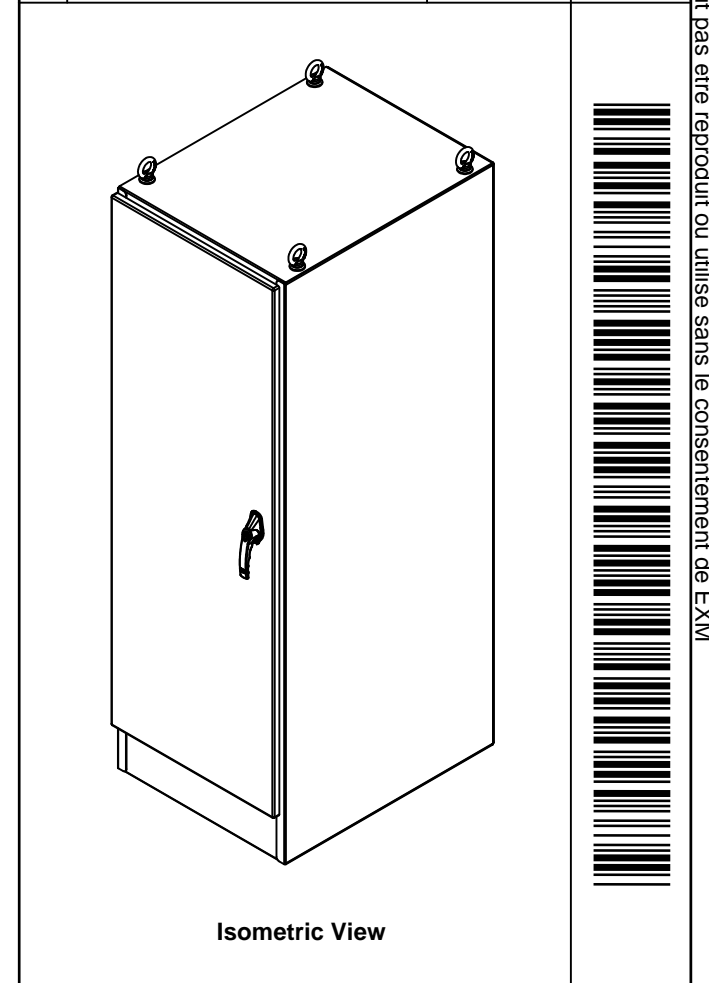

| PACKING | | |
|-----------------------|-----|--|
| ITEM | QTY | DESCRIPTION |
| Cardboard sleeve | 2 | Top and Bottom |
| Cardboard strip | 2 | Between back of enclosure and inner panel |
| Plastic bag | 1 | To protect cover surface and inside gasket |
| Cardboard corner | 4 | To reinforced for the plastic strap tightening |
| Plastic strap - Black | 2 | To Squeeze 2 cardboard sleeve together |
| Packaging label | 3 | White label with PN |
| Plastic strap- Green | 2 | To secure the enclosure to the wood pallet |
| Wood Pallet | 1 | 2" deeper and 3" larger than enclosure size |

| Qty | Part Number | Rev | Description |
|------------|----------------|-----|---|
| 1 | 9500ST722430GP | 0 | 9500 Gland Plate |
| 1 | 9500ST722430C | 0 | 9500 72" x 24" Cover |
| 1 | 9500ST722430B | 0 | 9500 72" x 24" x 30" Body |
| 2 | 880EB14 | 2 | Eye Bolt M14 (Pack of 2) |
| 4 | STK-Q-04050-10 | 8 | M6 x 10mm Hexagon Socket Head Machine Screw with Nyseal |
| Parts List | | | |

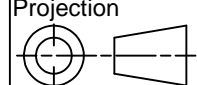
| | | |
|--|---|---|
|  Tél: (450) 979-4373 Fax: (450) 979-4626 www.exmweb.com | | Flatness Aplatissement Max 3.0mm Projection  |
| Customer Client | Date | |
| Drawn By Dessiné Par | BoxCad: BoxCad | Date 09-Dec-21 |
| Material Matière | 12 Ga Cold Rolled A1008 CS Type B (2.5mm) | |
| Color Couleur | Asa-61 Grey | Finish Fini Smooth |
| Description | Detail Rev. | |
| 9500 72" x 24" x 30" Assembly | | |
| Part Number Numéro Pièce | Rev. | 2 |
| 9500ST722430 | 0 | 2 |

This drawing is confidential and must not be reproduced or used without the consent of EXM

Ce dessin est confidentiel et ne doit pas être reproduit ou utilisé sans le consentement de EXM

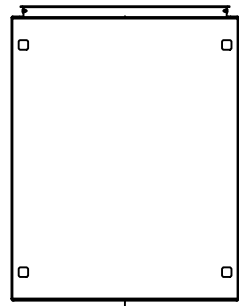

TOP

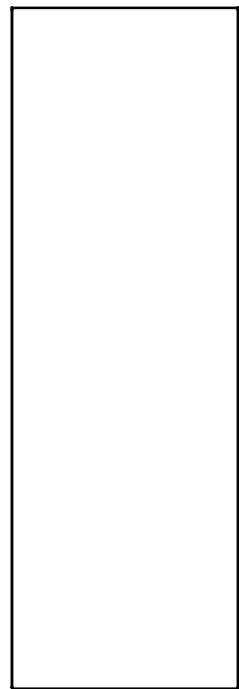

BACK

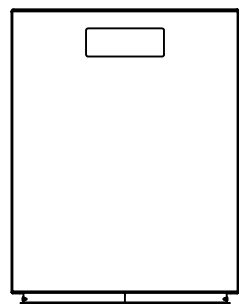

BOTTOM

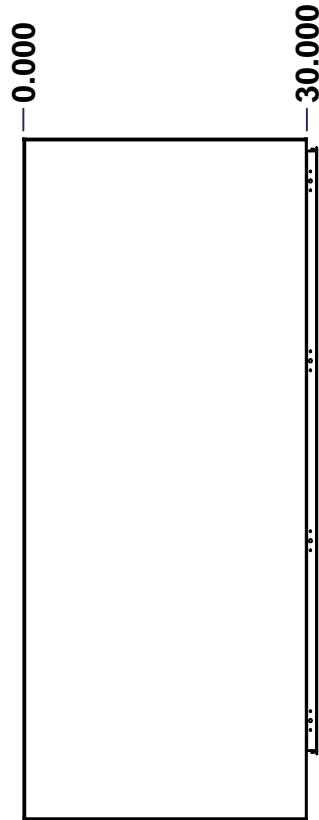

LEFT

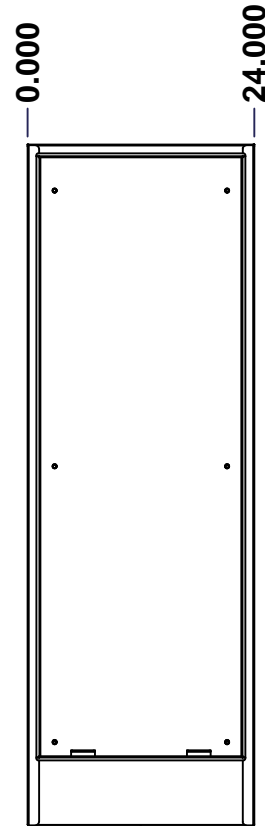

FRONT

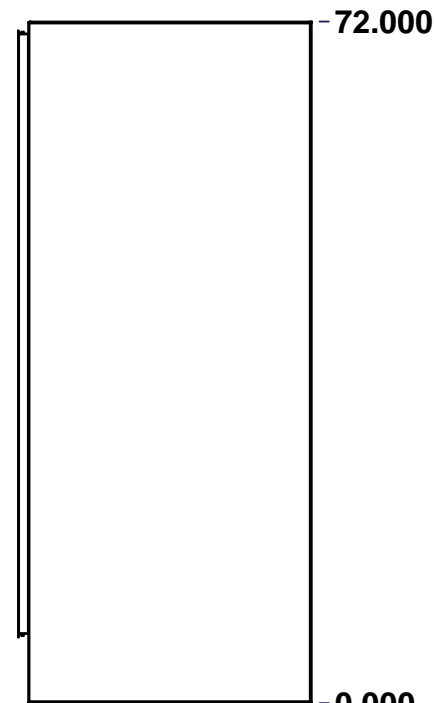

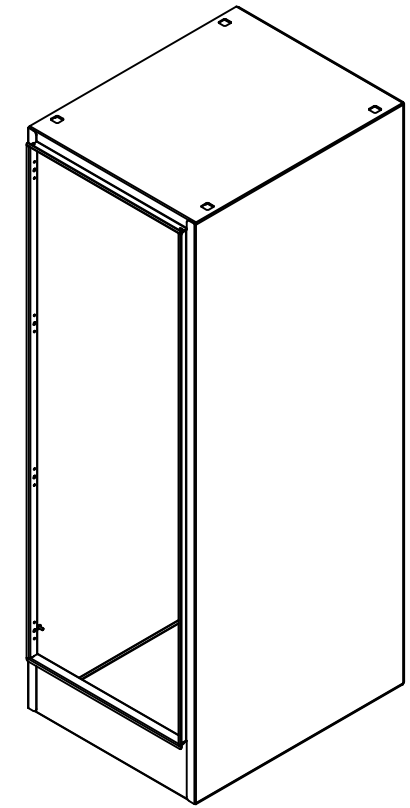

RIGHT



Isometric View

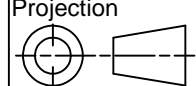

| No. | Revisions | Date | By/Par |
|-----|-----------|------|--------|
| | | | |
| | | | |
| | | | |
| | | | |
| | | | |

| | | |
|--|---|---|
|  Tél: (450) 979-4373 Fax: (450) 979-4626 www.exmweb.com | | Flatness Aplatissement  Max 3.0mm Projection  |
| Customer Client | Date | |
| Drawn By Dessiné Par | BoxCad: BoxCad | Date 09-Dec-21 |
| Material Matière | 12 Ga Cold Rolled A1008 CS Type B (2.5mm) | |
| Color Couleur | Asa-61 Grey | Finish Fini Smooth |
| Description | Detail Rev. | |
| 9500 72" x 24" x 30" Body | | |
| Part Number Numéro Pièce | Rev. 0 | 1 2 |
| 9500ST722430B | | |

SEE BILL OF MATERIAL ON LAST PAGE

This drawing is confidential and must not be reproduced or used without the consent of EXM

Ce dessin est confidentiel et ne doit pas être reproduit ou utilisé sans le consentement de EXM

STANDARD FEATURES ARE NOT LISTED IN THIS HOLE TABLE

HOLE TABLE - TOP VIEW (CUSTOM FEATURE ONLY)

| CUT-OUT | XDIM | YDIM | DESCRIPTION |
|---------|--------|--------|-------------------------------|
| 1 | 11.911 | 25.911 | Struts CR400 17.500" (Inside) |
| 2 | 11.911 | 25.911 | STUDS M6 x 10mm (Inside) |
| 3 | 6.161 | 25.911 | STUDS M6 x 10mm (Inside) |
| 4 | 17.661 | 25.911 | STUDS M6 x 10mm (Inside) |

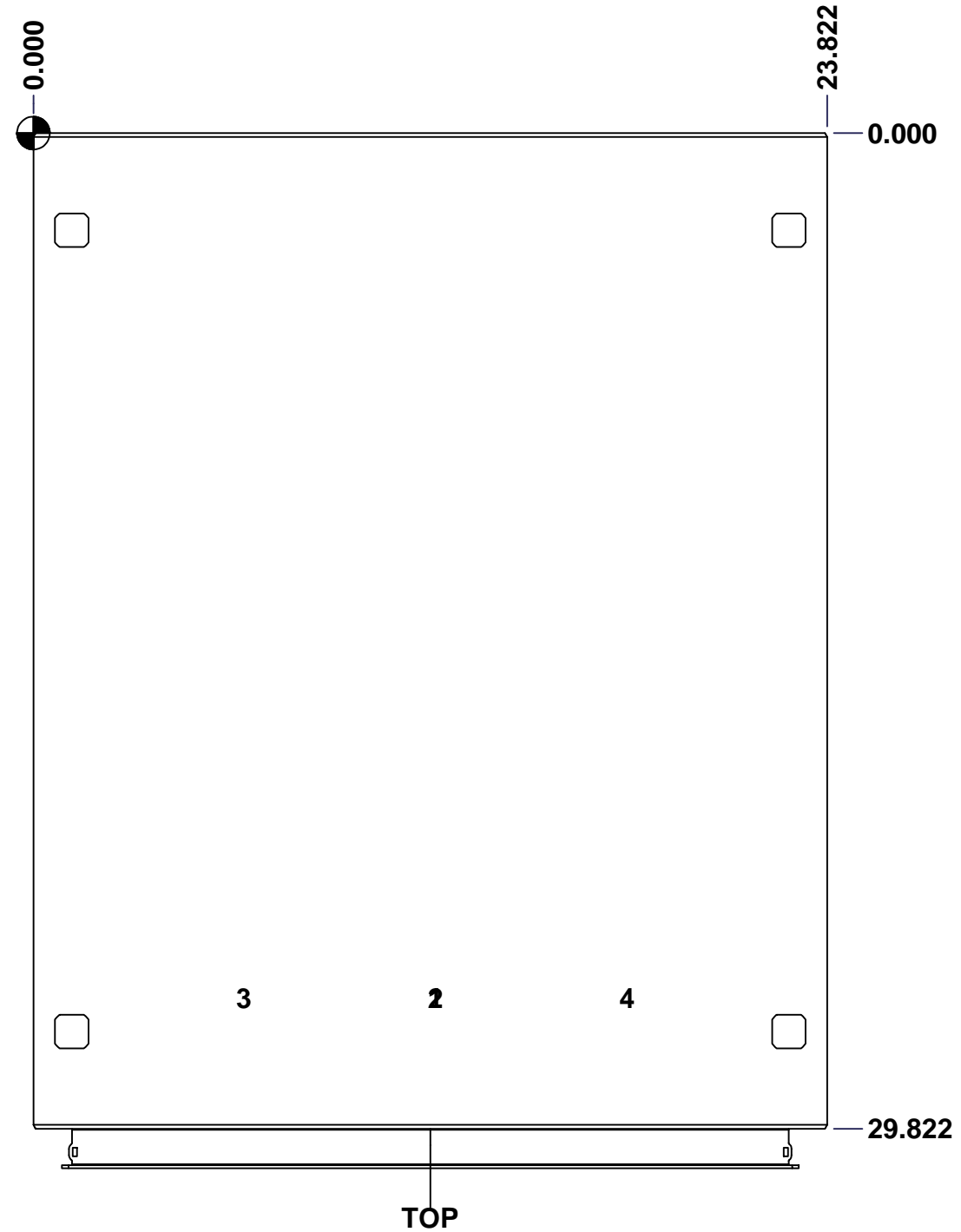

| | | |
|--|-----------------------------|----------|
| | Description | Status |
| | 9500 72" x 24" x 30" Body | Released |
| | Part Number Numéro Pièce | Rev. |
| | 9500ST722430B | 0 |
| | | 2 / 7 |

This drawing is confidential and must not be reproduced or used without the consent of EXM

Ce dessin est confidentiel et ne doit pas être reproduit ou utilisé sans le consentement de EXM

| STANDARD FEATURES ARE NOT LISTED IN THIS HOLE TABLE | | | |
|---|--------|-------|----------------------------|
| HOLE TABLE - BOTTOM VIEW (CUSTOM FEATURE ONLY) | | | |
| CUT-OUT | XDIM | YDIM | DESCRIPTION |
| 1 | 7.286 | 3.411 | GP STUD M6 x 16mm (Inside) |
| 2 | 16.536 | 3.411 | GP STUD M6 x 16mm (Inside) |

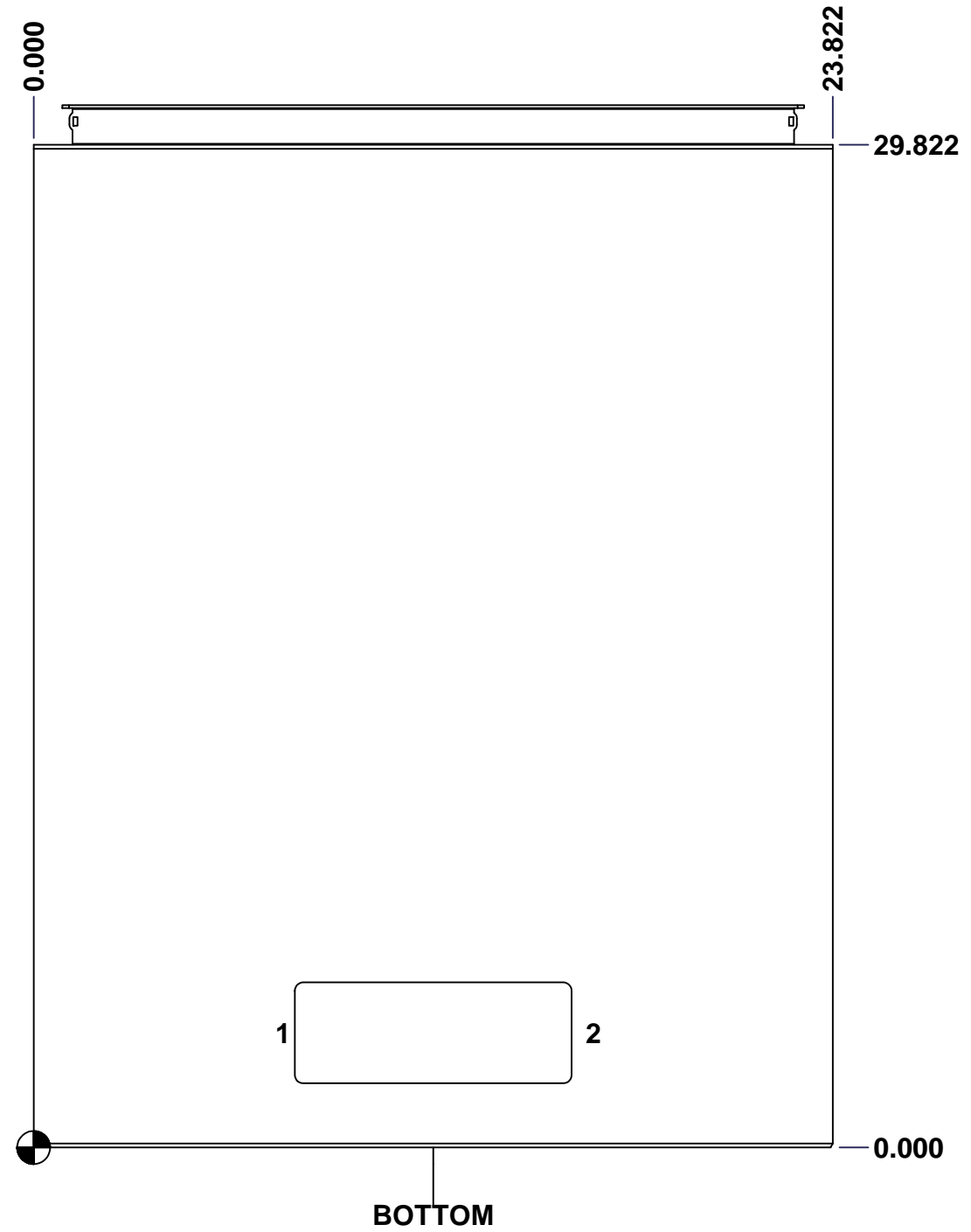

| | | |
|--|-----------------------------|----------|
| | Description | Status |
| | 9500 72" x 24" x 30" Body | Released |
| | Part Number Numéro Pièce | Rev. |
| | 9500ST722430B | 0 |
| | | 4 |
| | | 7 |

This drawing is confidential and must not be reproduced or used without the consent of EXM

Ce dessin est confidentiel et ne doit pas être reproduit ou utilisé sans le consentement de EXM

| STANDARD FEATURES ARE NOT LISTED IN THIS HOLE TABLE | | | |
|--|--------|-------|-----------------------------|
| HOLE TABLE - LEFT VIEW (CUSTOM FEATURE ONLY) | | | |
| CUT-OUT | XDIM | YDIM | DESCRIPTION |
| 1 | 28.411 | 9.286 | GND STUD M6 x 16mm (Inside) |

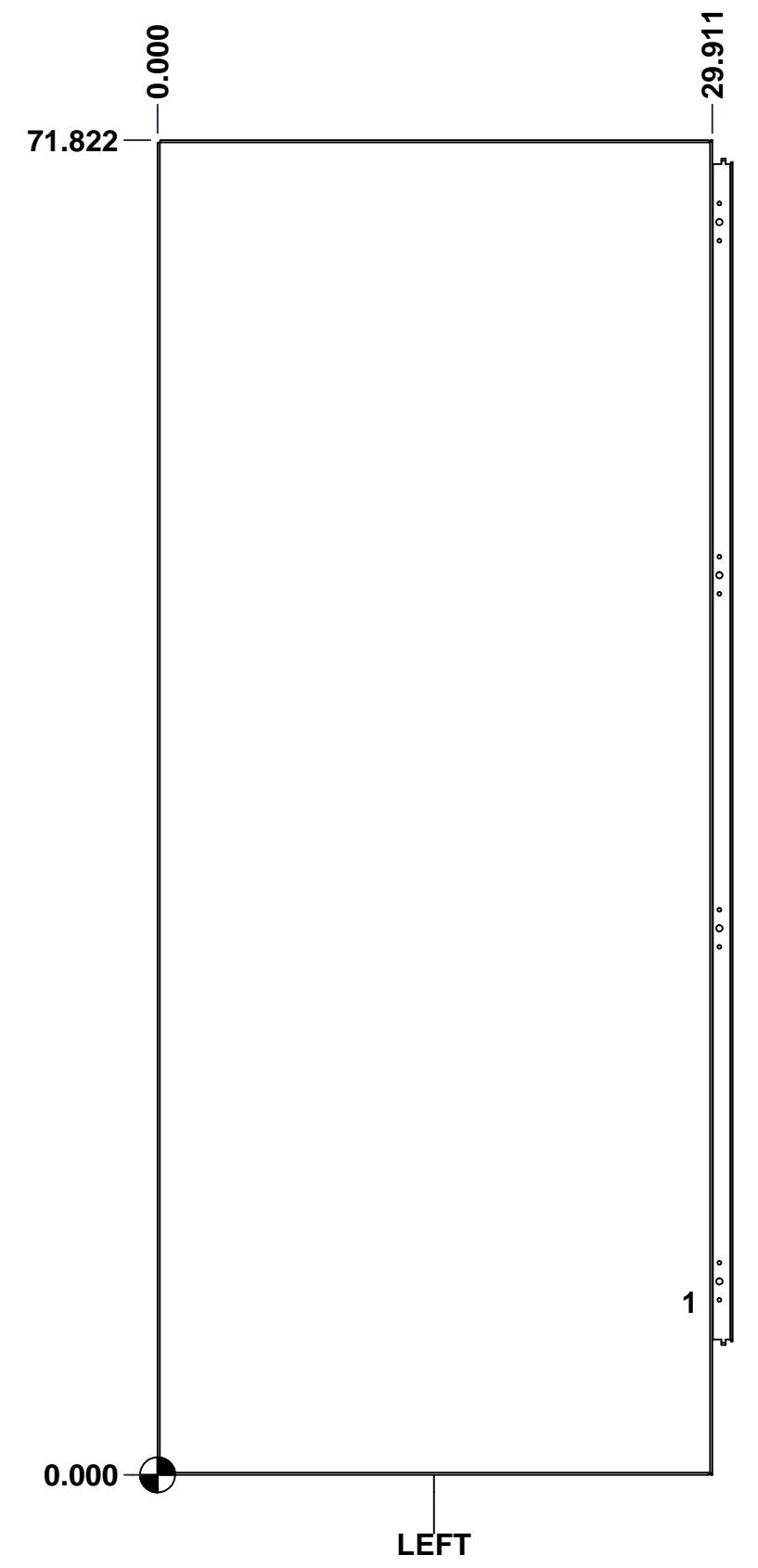

| | | | |
|--|-----------------------------|----------|---|
| | Description | Status | |
| | 9500 72" x 24" x 30" Body | Released | |
| | Part Number Numéro Pièce | Rev. | 5 |
| | 9500ST722430B | 0 | 7 |

This drawing is confidential and must not be reproduced or used without the consent of EXM

Ce dessin est confidentiel et ne doit pas être reproduit ou utilisé sans le consentement de EXM

STANDARD FEATURES ARE NOT LISTED IN THIS HOLE TABLE

HOLE TABLE - BACK VIEW (CUSTOM FEATURE ONLY)

| CUT-OUT | XDIM | YDIM | DESCRIPTION |
|---------|--------|--------|-----------------------------|
| 1 | 2.786 | 8.786 | IP STUD M10 x 40mm (Inside) |
| 2 | 21.036 | 8.786 | IP STUD M10 x 40mm (Inside) |
| 3 | 2.786 | 37.911 | IP STUD M10 x 40mm (Inside) |
| 4 | 21.036 | 37.911 | IP STUD M10 x 40mm (Inside) |
| 5 | 2.786 | 67.036 | IP STUD M10 x 40mm (Inside) |
| 6 | 21.036 | 67.036 | IP STUD M10 x 40mm (Inside) |
| ----- | ----- | ----- | ----- |
| 7 | 18.036 | 7.411 | IP SUPPORT ANGLE (Inside) |
| 8 | 5.786 | 7.411 | IP SUPPORT ANGLE (Inside) |

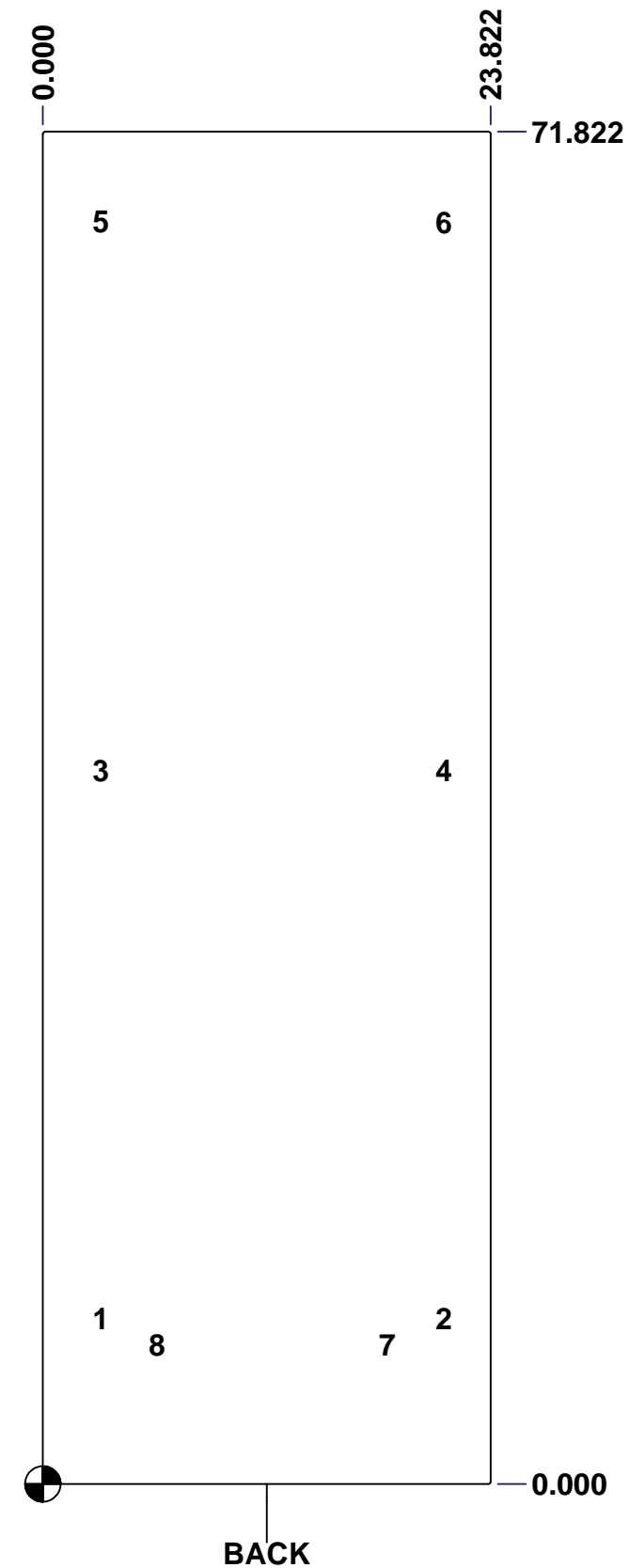

BACK

| | | |
|--|-----------------------------|----------|
| | Description | Status |
| | 9500 72" x 24" x 30" Body | Released |
| | Part Number Numéro Pièce | Rev. |
| | 9500ST722430B | 0 |
| | | 6 |
| | | 7 |

This drawing is confidential and must not be reproduced or used without the consent of EXM

Ce dessin est confidentiel et ne doit pas être reproduit ou utilisé sans le consentement de EXM

| No. | Revisions | Date | By/Par |
|-----|-----------|------|--------|
| | | | |
| | | | |
| | | | |
| | | | |
| | | | |

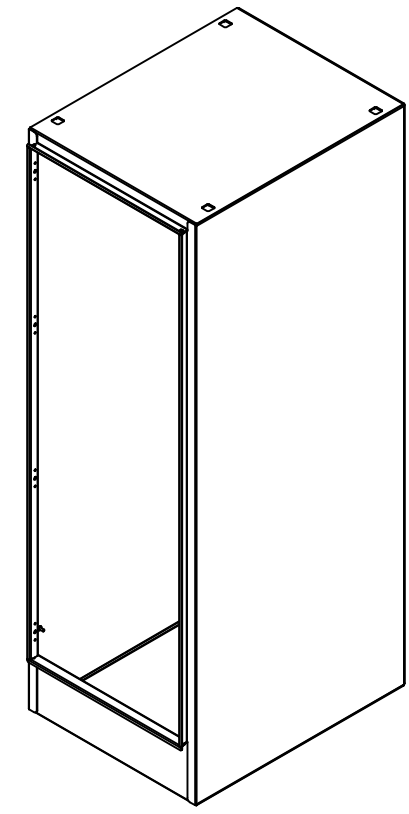

Isometric View

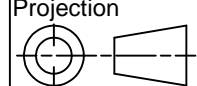

| Qty | Part Number | Rev | Description |
|-----|-------------------|-----|--|
| 3 | STK-Q-16030 | 0 | Stud M6 x 10mm |
| 2 | 9500ST722430BPA-P | 0 | 9500 Inner Panel Support Angle |
| 3 | STK-Q-07220 | 1 | M6 Nylon Insert Lock Nut |
| 1 | CR400MS_17.5 | 0 | Commercial Roll Mild Steel (17.5in long) |
| 1 | STK-P-02400S | 0 | Powder Paint (Asa-61 Grey / Smooth) |
| 6 | STK-Q-16100 | 0 | Stud M10 x 40mm |
| 1 | 9500ST722430BT-P | 0 | 9500 24" x 30" Bottom Part |
| 1 | 9500ST722430T-P | 0 | 9500 24" x 30" Top Part |
| 1 | 9500ST722430RS-P | 0 | 9500 72" x 24" Right Part |
| 1 | 9500ST722430LS-P | 0 | 9500 72" x 24" Left Part |
| 1 | 9500ST722430B-P | 0 | 9500 72" x 24" Back Part |
| 3 | STK-Q-16080 | 0 | Ground Stud M6 x 16mm |
| | | | |
| | | | |
| | | | |

| | | |
|--|---|---|
|  Tél: (450) 979-4373 Fax: (450) 979-4626 www.exmweb.com | | Flatness Aplatissement Max 3.0mm Projection  |
| Customer Client | Date | Date |
| Drawn By Dessiné Par | BoxCad: BoxCad | 09-Dec-21 |
| Material Matière | 12 Ga Cold Rolled A1008 CS Type B (2.5mm) | |
| Color Couleur | Asa-61 Grey | Finish Fini: Smooth |
| Description | 9500 72" x 24" x 30" Body | |
| Part Number Numéro Pièce | Rev. | 2 |
| 9500ST722430B | 0 | 2 |

Parts List

This drawing is confidential and must not be reproduced or used without the consent of EXM

Ce dessin est confidentiel et ne doit pas être reproduit ou utilisé sans le consentement de EXM



TOP

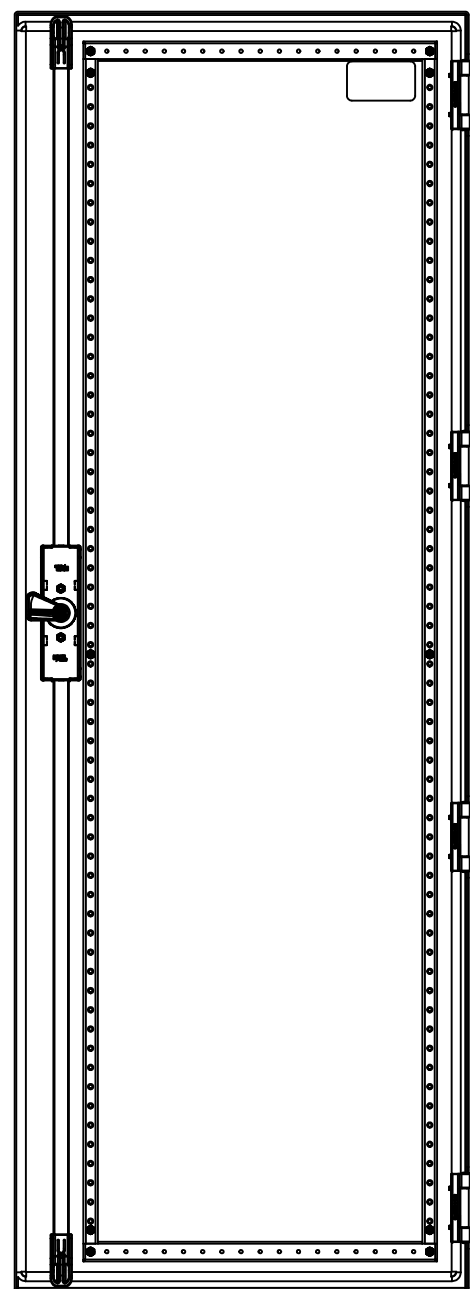

BACK



BOTTOM

0.000
0.835

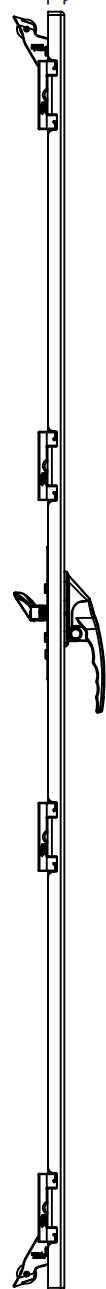

LEFT

0.000
23.312

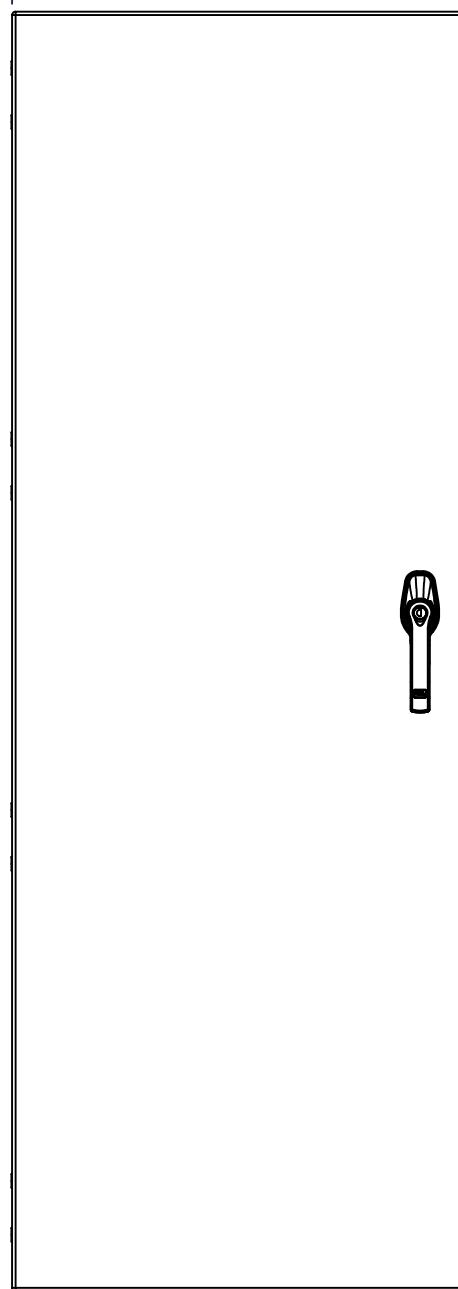

FRONT

65.549

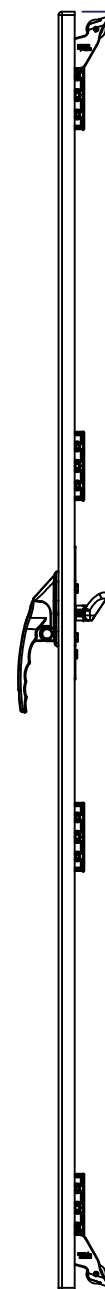

RIGHT

0.000

| No. | Revisions | Date | By/Par |
|-----|-----------|------|--------|
| | | | |
| | | | |
| | | | |
| | | | |
| | | | |

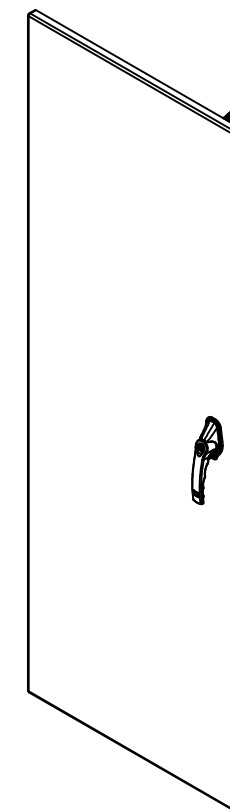

Isometric View



Tél: (450) 979-4373
Fax: (450) 979-4626
www.exmweb.com

Flatness
Aplatissement

Max 3.0mm

Projection

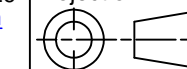

| | |
|---|-----------------------|
| Customer Client | Date |
| Drawn By Dessiné Par BoxCad: BoxCad | Date 09-Dec-21 |
| Material Matière 12 Ga Cold Rolled A1008 CS Type B (2.5mm) | |
| Color Couleur Asa-61 Grey | Finish Fini Smooth |

| | |
|-------------------------------------|-------------|
| Description 9500 72" x 24" Cover | Detail Rev. |
|-------------------------------------|-------------|

| | | |
|---|----------|---|
| Part Number Numéro Pièce 9500ST722430C | Rev. 1 | 3 |
| | 0 | |

SEE BILL OF MATERIAL ON LAST PAGE

This drawing is confidential and must not be reproduced or used without the consent of EXM

Ce dessin est confidentiel et ne doit pas être reproduit ou utilisé sans le consentement de EXM

STANDARD FEATURES ARE NOT LISTED IN THIS HOLE TABLE

HOLE TABLE - FRONT VIEW (CUSTOM FEATURE ONLY)

| CUT-OUT | XDIM | YDIM | DESCRIPTION |
|---------|--------|--------|------------------------------|
| 1 | 2.000 | 2.028 | STUD M6 x 18mm (Inside) |
| 2 | 2.000 | 32.628 | STUD M6 x 18mm (Inside) |
| 3 | 2.000 | 63.521 | STUD M6 x 18mm (Inside) |
| 4 | 19.407 | 2.028 | STUD M6 x 18mm (Inside) |
| 5 | 19.407 | 32.628 | STUD M6 x 18mm (Inside) |
| 6 | 19.407 | 63.521 | STUD M6 x 18mm (Inside) |
| 7 | 2.000 | 3.139 | STUD M6 x 18mm (Inside) |
| 8 | 2.000 | 62.409 | STUD M6 x 18mm (Inside) |
| 9 | 19.407 | 3.139 | STUD M6 x 18mm (Inside) |
| 10 | 19.407 | 62.409 | STUD M6 x 18mm (Inside) |
| 11 | 20.937 | 6.118 | STUD M6 x 18mm (Inside) |
| 12 | 20.937 | 59.430 | STUD M6 x 18mm (Inside) |
| ----- | ----- | ----- | ----- |
| 13 | 20.937 | 34.743 | HANDLE 885 ESL2A-APHK @ 0.0° |

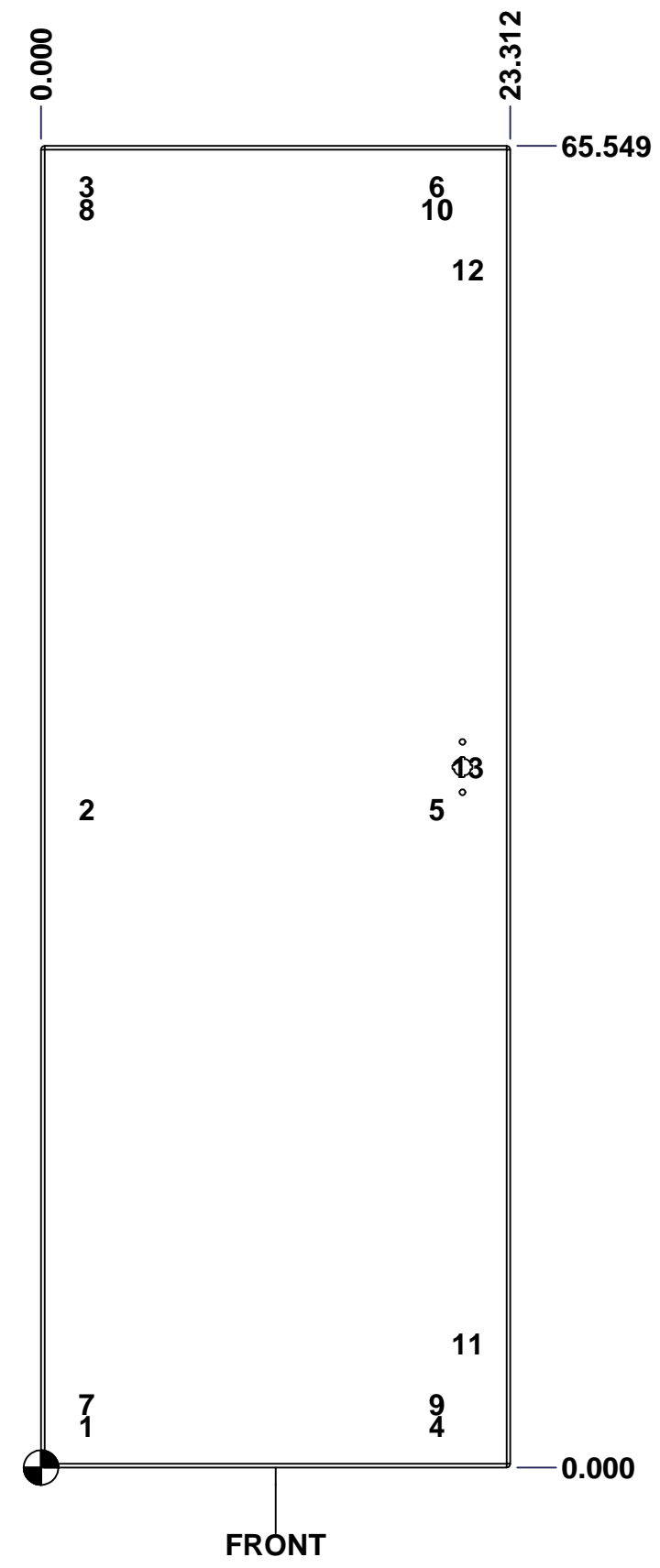

FRONT

| | | |
|--|-----------------------------|----------|
| | Description | Status |
| | 9500 72" x 24" Cover | (NULL) |
| | Part Number Numéro Pièce | Rev. |
| | 9500ST722430C | 0 |
| | | 2 |
| | | 3 |

