

This drawing is confidential and must not be reproduced or used without the consent of EXM

Ce dessin est confidentiel et ne doit pas être reproduit ou utilisé sans le consentement de EXM

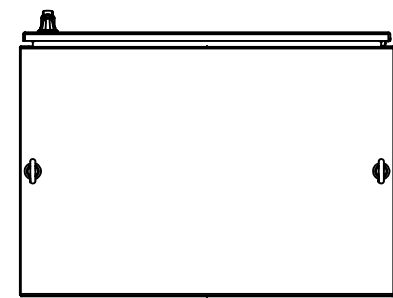

TOP

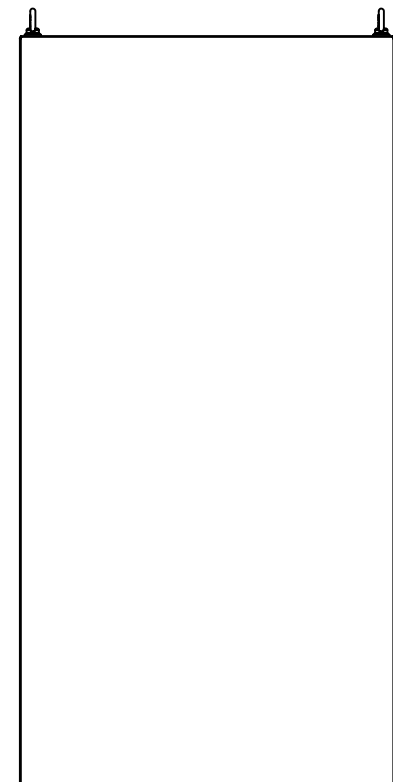

BACK

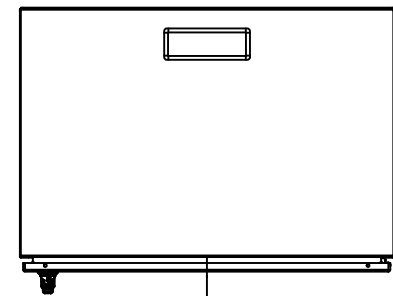

BOTTOM

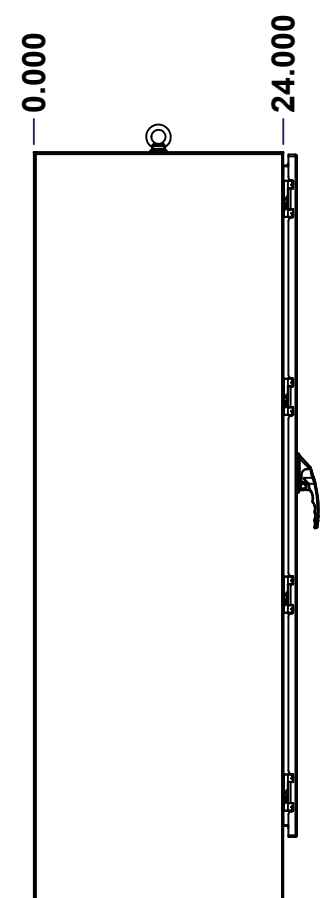

LEFT

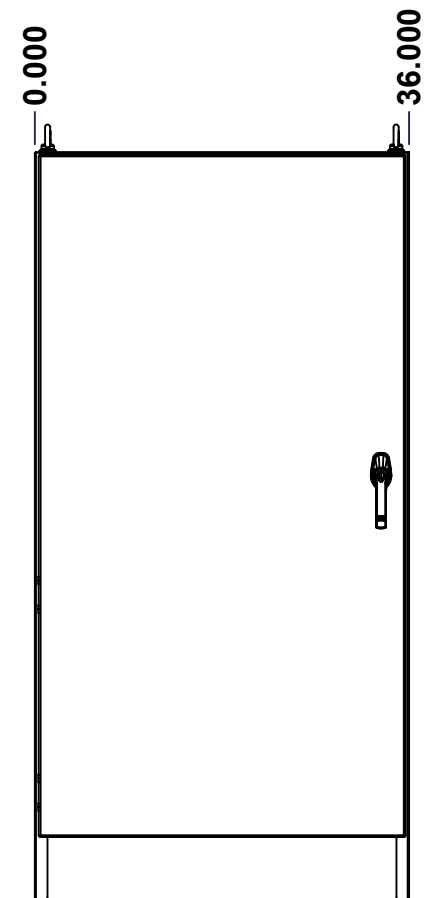

FRONT

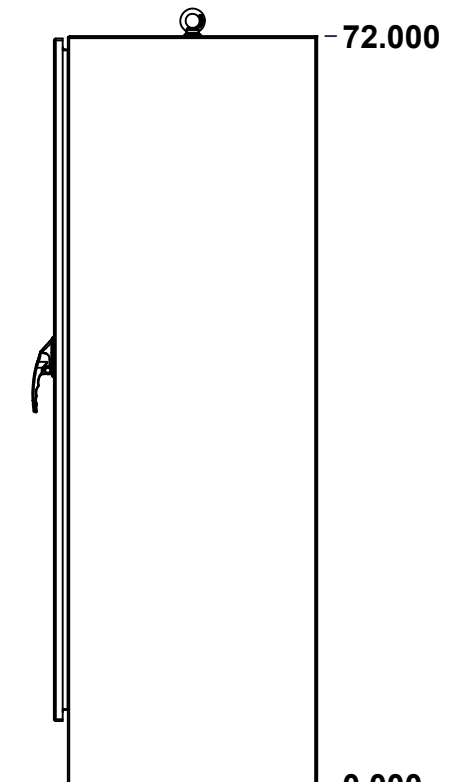

RIGHT

No.	Revisions	Date	By/Par

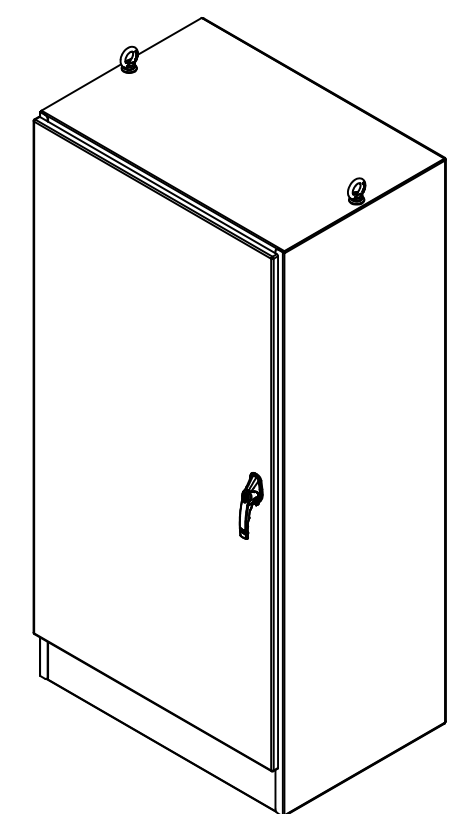

Isometric View

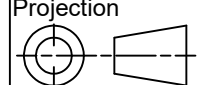

 Tél: (450) 979-4373 Fax: (450) 979-4626 <a href="http://www.exmweb.com">www.exmweb.com</a>		Flatness Aplatissement Max 3.0mm Projection 
Customer Client	Date	
Drawn By Dessiné Par	BoxCad: BoxCad	Date 12/9/2021
Material Matière	12 Ga Cold Rolled A1008 CS Type B (2.5mm)	
Color Couleur	Asa-61 Grey	Finish Fini Smooth
Description 9500 72" x 36" x 24" Assembly		Detail Rev.
Part Number Numéro Pièce	9500ST723624	Rev. 1 0

SEE BILL OF MATERIAL ON LAST PAGE

This drawing is confidential and must not be reproduced or used without the consent of EXM

Ce dessin est confidentiel et ne doit pas être reproduit ou utilisé sans le consentement de EXM

NOTE	
ITEM	DESCRIPTION
1	NEMA 12/13 Enclosure
2	C/W Standard ground studs on box and cover
3	C/W Standard door stiffener
4	W/O Inner panel
5	C/W Standard inner panel mounting studs
6	C/W Eyebolts
7	C/W Struts installed (Included)

No.	Revisions	Date	By/Par

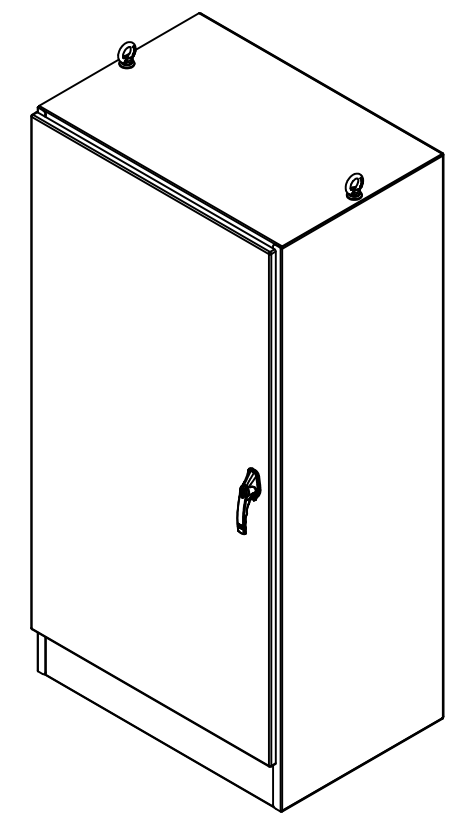

Isometric View



PACKING		
ITEM	QTY	DESCRIPTION
Cardboard sleeve	2	Top and Bottom
Cardboard strip	2	Between back of enclosure and inner panel
Plastic bag	1	To protect cover surface and inside gasket
Cardboard corner	4	To reinforced for the plastic strap tightening
Plastic strap - Black	2	To Squeeze 2 cardboard sleeve together
Packaging label	3	White label with PN
Plastic strap- Green	2	To secure the enclosure to the wood pallet
Wood Pallet	1	2" deeper and 3" larger than enclosure size

Qty	Part Number	Rev	Description
1	9500ST723624GP	0	9500 Gland Plate
1	880EB14	2	Eye Bolt M14 (Pack of 2)
1	9500ST723624C	0	9500 72" x 36" Cover
1	9500ST723624B	0	9500 72" x 36" x 24" Body
4	STK-Q-04050-10	8	M6 x 10mm Hexagon Socket Head Machine Screw with Nyseal
Parts List			

		Tél: (450) 979-4373 Fax: (450) 979-4626 <a href="http://www.exmweb.com">www.exmweb.com</a>		Flatness Aplatissement Max 3.0mm
Customer Client		Date		
Drawn By Dessiné Par BoxCad: BoxCad		Date 12/9/2021		
Material Matière 12 Ga Cold Rolled A1008 CS Type B (2.5mm)		Color Couleur Asa-61 Grey		Finish Fini Smooth
Description 9500 72" x 36" x 24" Assembly			Detail Rev.	
Part Number Numéro Pièce <b>9500ST723624</b>			Rev. <b>0</b>	2 / 2

This drawing is confidential and must not be reproduced or used without the consent of EXM

Ce dessin est confidentiel et ne doit pas être reproduit ou utilisé sans le consentement de EXM



TOP

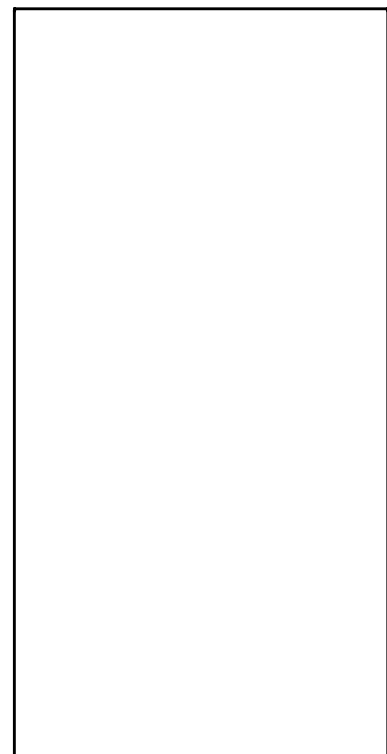

BACK

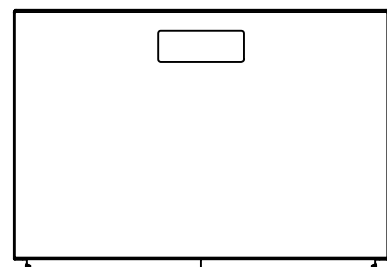

BOTTOM

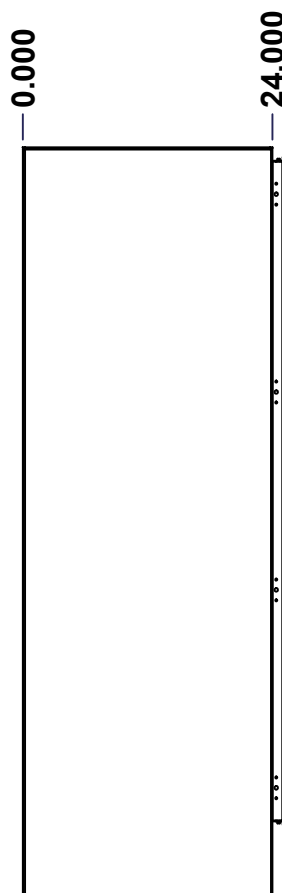

LEFT

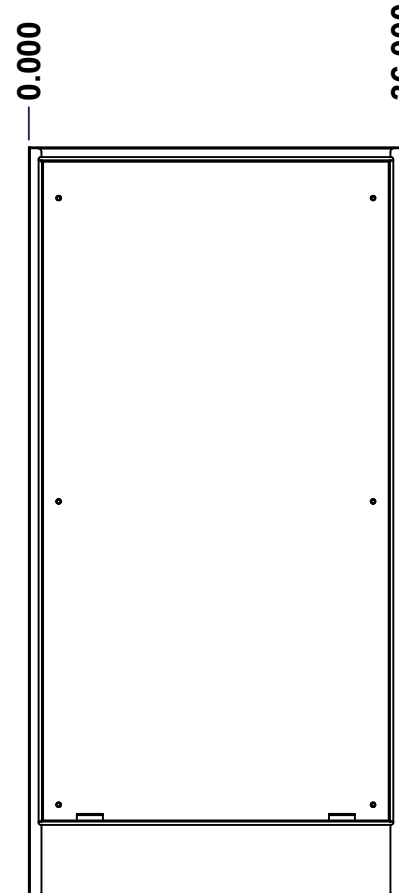

FRONT

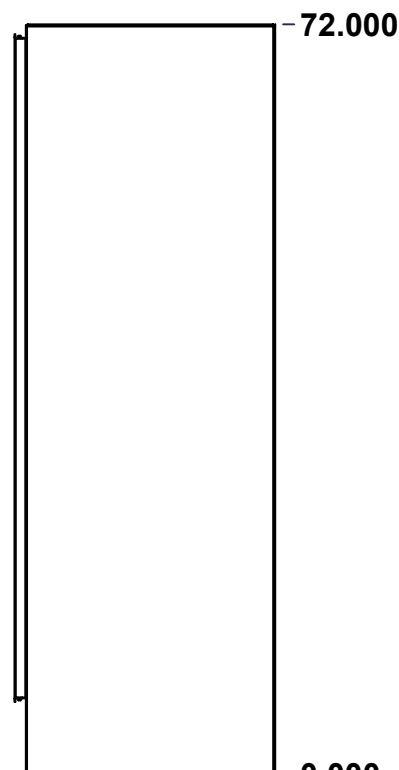

RIGHT

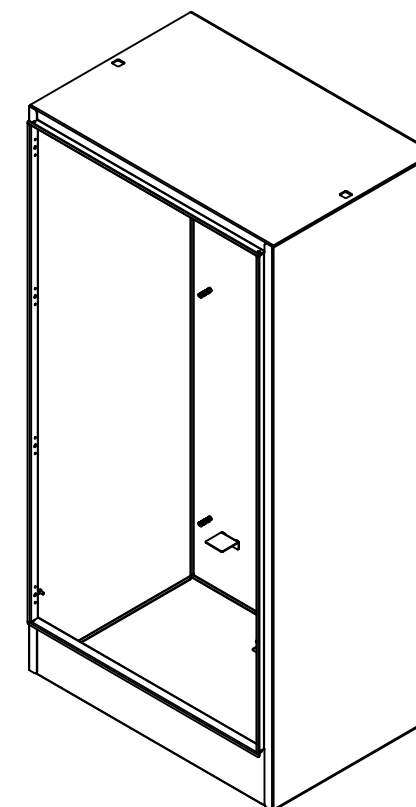

Isometric View

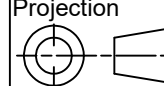

No.	Revisions	Date	By/Par

 Tél: (450) 979-4373 Fax: (450) 979-4626 <a href="http://www.exmweb.com">www.exmweb.com</a>		Flatness Aplatissement Max 3.0mm Projection 
Customer Client	Date	
Drawn By Dessiné Par	BoxCad: BoxCad	Date 12/9/2021
Material Matière	12 Ga Cold Rolled A1008 CS Type B (2.5mm)	
Color Couleur	Asa-61 Grey	Finish Fini Smooth
Description 9500 72" x 36" x 24" Body		Detail Rev.
Part Number Numéro Pièce	9500ST723624B	Rev. 1 0

SEE BILL OF MATERIAL ON LAST PAGE

This drawing is confidential and must not be reproduced or used without the consent of EXM

Ce dessin est confidentiel et ne doit pas être reproduit ou utilisé sans le consentement de EXM

**STANDARD FEATURES ARE NOT LISTED IN THIS HOLE TABLE**

**HOLE TABLE - TOP VIEW (CUSTOM FEATURE ONLY)**

CUT-OUT	XDIM	YDIM	DESCRIPTION
1	17.911	19.911	Struts CR400 27.500" (Inside)
2	17.911	19.911	STUDS M6 x 10mm (Inside)
3	7.161	19.911	STUDS M6 x 10mm (Inside)
4	28.661	19.911	STUDS M6 x 10mm (Inside)

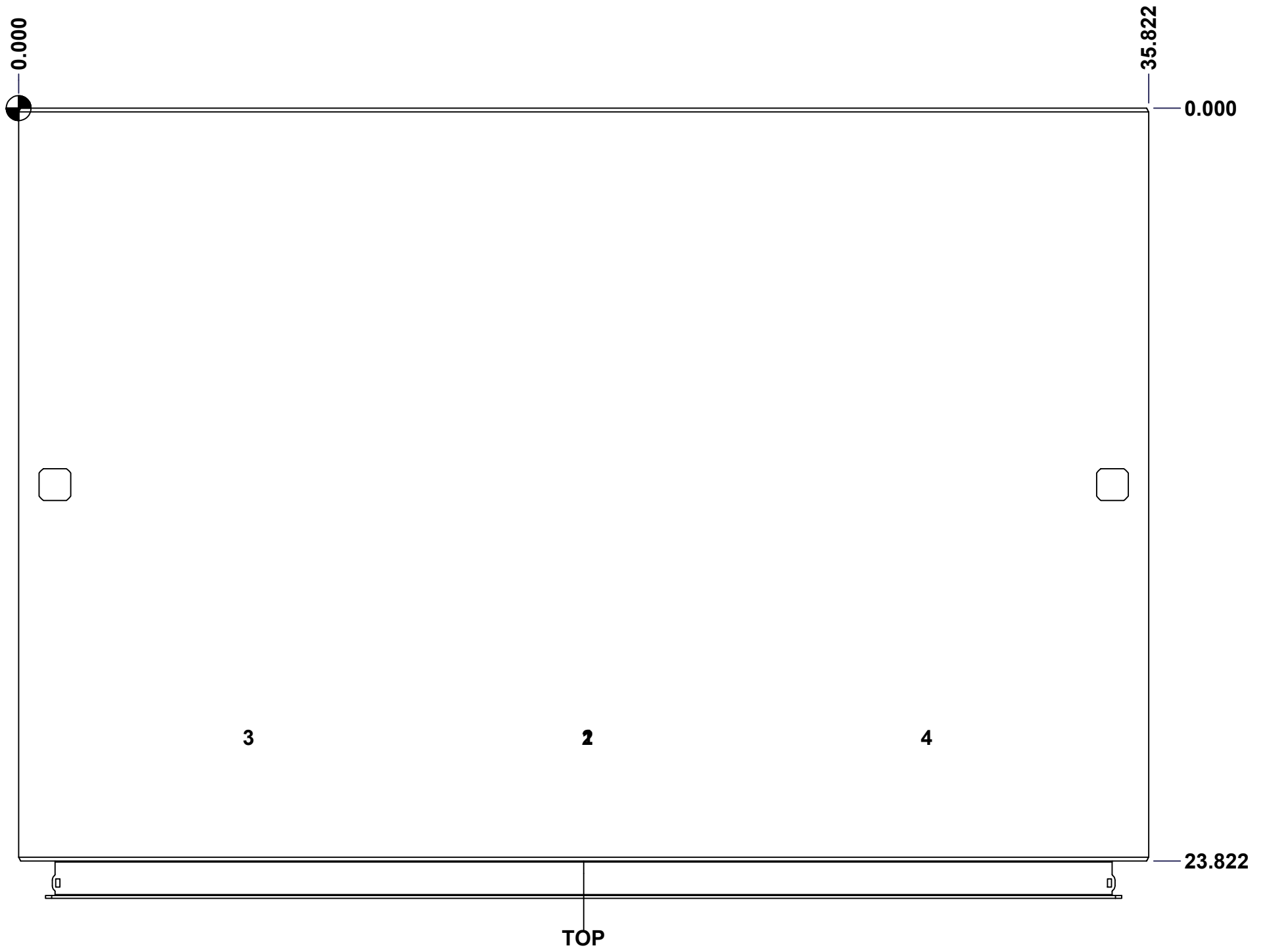

	Description	Status	
	9500 72" x 36" x 24" Body	Released	
	Part Number Numéro Pièce	Rev.	
	<b>9500ST723624B</b>	<b>0</b>	2 / 7

This drawing is confidential and must not be reproduced or used without the consent of EXM

Ce dessin est confidentiel et ne doit pas être reproduit ou utilisé sans le consentement de EXM

STANDARD FEATURES ARE NOT LISTED IN THIS HOLE TABLE			
HOLE TABLE - BOTTOM VIEW (CUSTOM FEATURE ONLY)			
CUT-OUT	XDIM	YDIM	DESCRIPTION
1	13.286	3.411	GP STUD M6 x 16mm (Inside)
2	22.536	3.411	GP STUD M6 x 16mm (Inside)

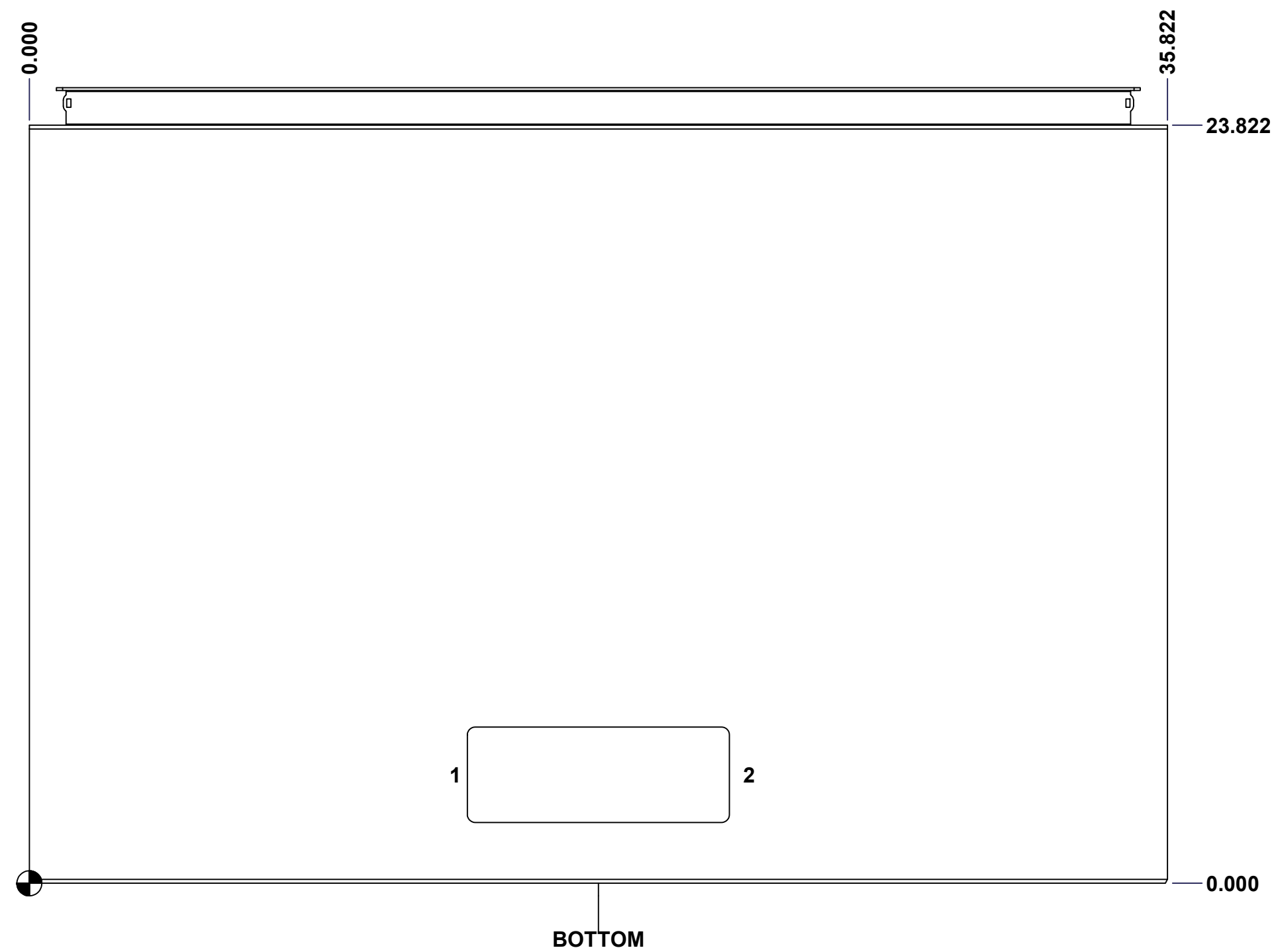

	Description	Status
	9500 72" x 36" x 24" Body	Released
	Part Number Numéro Pièce	Rev.
	<b>9500ST723624B</b>	<b>0</b>
		4 / 7

This drawing is confidential and must not be reproduced or used without the consent of EXM

Ce dessin est confidentiel et ne doit pas être reproduit ou utilisé sans le consentement de EXM

STANDARD FEATURES ARE NOT LISTED IN THIS HOLE TABLE			
HOLE TABLE - LEFT VIEW (CUSTOM FEATURE ONLY)			
CUT-OUT	XDIM	YDIM	DESCRIPTION
1	22.411	9.286	GND STUD M6 x 16mm (Inside)

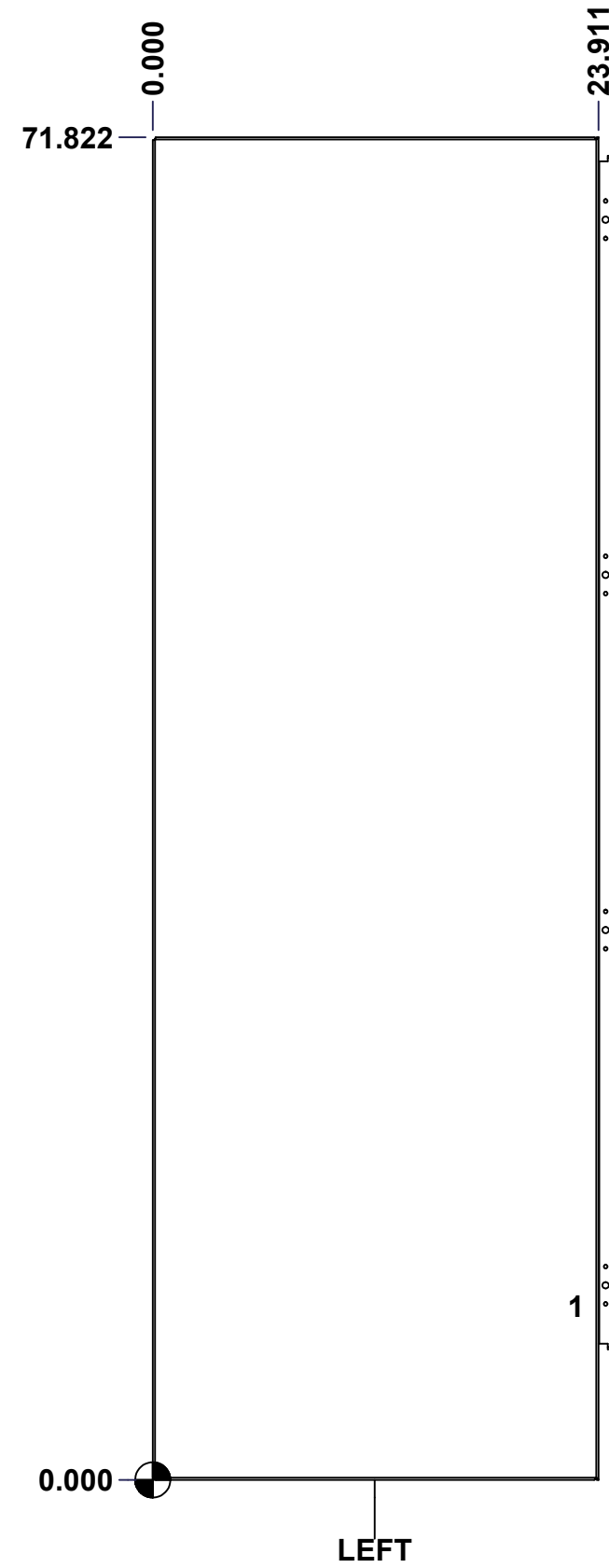

	Description	Status	
	9500 72" x 36" x 24" Body	Released	
	Part Number Numéro Pièce	Rev.	
	<b>9500ST723624B</b>	<b>0</b>	5 / 7

This drawing is confidential and must not be reproduced or used without the consent of EXM

Ce dessin est confidentiel et ne doit pas être reproduit ou utilisé sans le consentement de EXM

**STANDARD FEATURES ARE NOT LISTED IN THIS HOLE TABLE**

**HOLE TABLE - BACK VIEW (CUSTOM FEATURE ONLY)**

CUT-OUT	XDIM	YDIM	DESCRIPTION
1	2.786	8.786	IP STUD M10 x 40mm (Inside)
2	33.036	8.786	IP STUD M10 x 40mm (Inside)
3	2.786	37.911	IP STUD M10 x 40mm (Inside)
4	33.036	37.911	IP STUD M10 x 40mm (Inside)
5	2.786	67.036	IP STUD M10 x 40mm (Inside)
6	33.036	67.036	IP STUD M10 x 40mm (Inside)
-----	-----	-----	-----
7	30.036	7.411	IP SUPPORT ANGLE (Inside)
8	5.786	7.411	IP SUPPORT ANGLE (Inside)

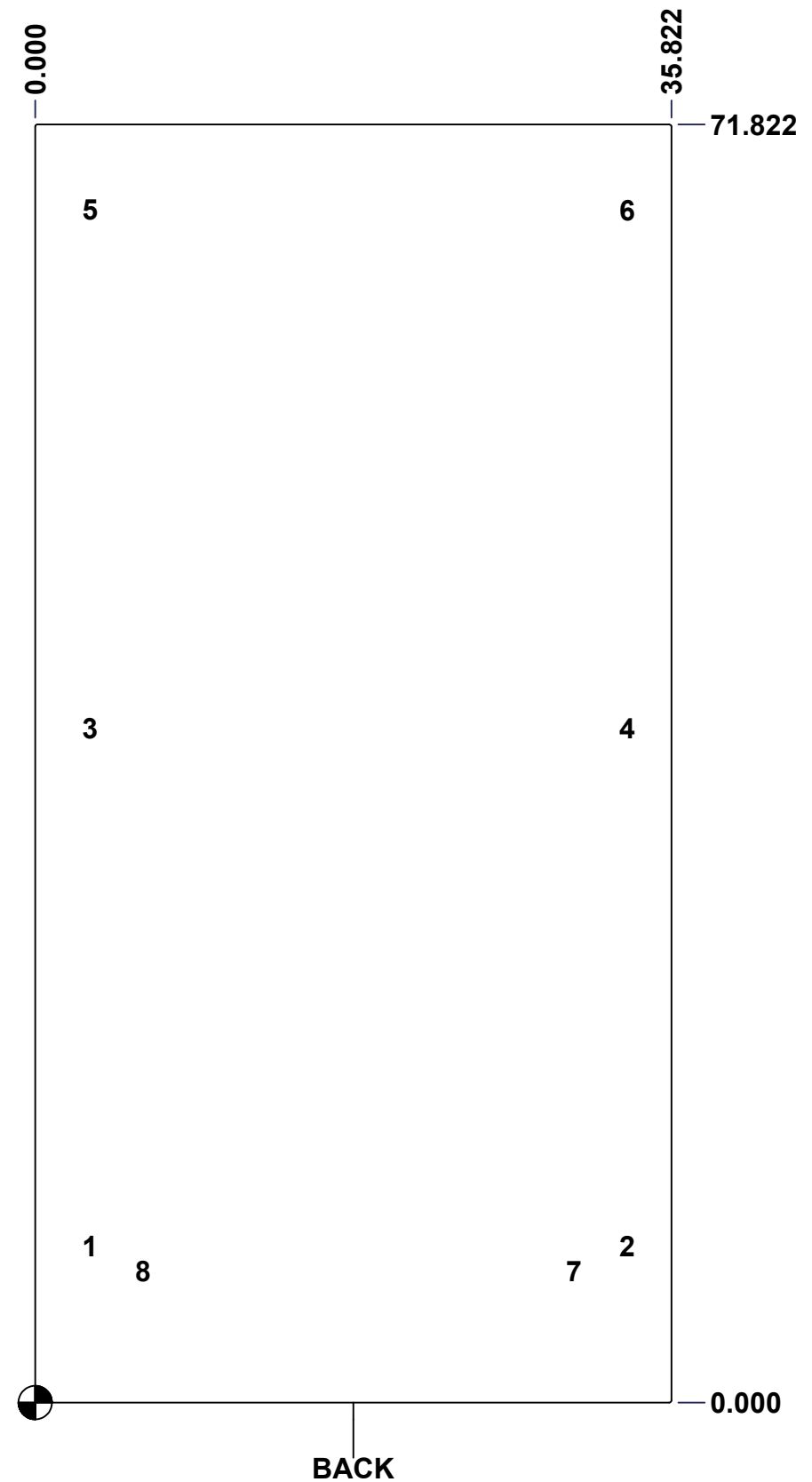

	Description	Status
	9500 72" x 36" x 24" Body	Released
	Part Number Numéro Pièce	Rev.
	<b>9500ST723624B</b>	<b>0</b>
		6
		7

This drawing is confidential and must not be reproduced or used without the consent of EXM

Ce dessin est confidentiel et ne doit pas être reproduit ou utilisé sans le consentement de EXM

No.	Revisions	Date	By/Par

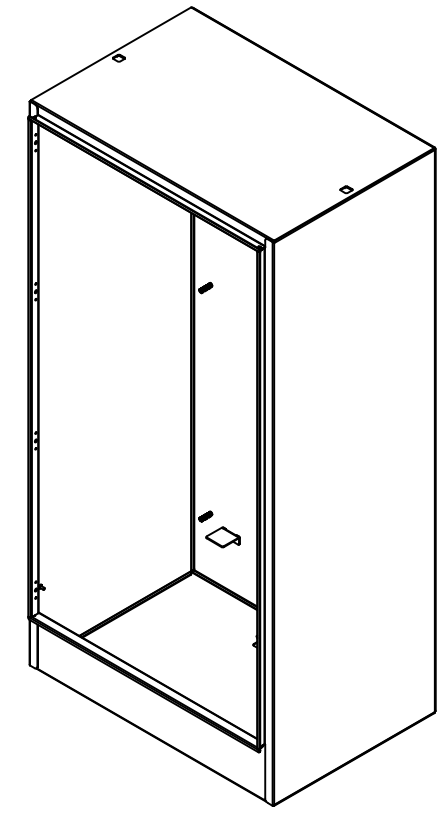

Isometric View

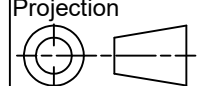

Qty	Part Number	Rev	Description
3	STK-Q-16030	0	Stud M6 x 10mm
3	STK-Q-07220	1	M6 Nylon Insert Lock Nut
1	CR400MS_27.5	0	Commercial Roll Mild Steel (27.5in long)
2	9500ST723624BPA-P	0	9500 Inner Panel Support Angle
1	STK-P-02400S	0	Powder Paint (Asa-61 Grey / Smooth)
6	STK-Q-16100	0	Stud M10 x 40mm
1	9500ST723624BT-P	0	9500 36" x 24" Bottom Part
1	9500ST723624T-P	0	9500 36" x 24" Top Part
1	9500ST723624RS-P	0	9500 72" x 36" Right Part
1	9500ST723624LS-P	0	9500 72" x 36" Left Part
1	9500ST723624B-P	0	9500 72" x 36" Back Part
3	STK-Q-16080	0	Ground Stud M6 x 16mm
Qty	Part Number	Rev	Description
Parts List			

 Tél: (450) 979-4373 Fax: (450) 979-4626 <a href="http://www.exmweb.com">www.exmweb.com</a>		Flatness Aplatissement Max 3.0mm Projection 
Customer Client	Date	Date
Drawn By Dessiné Par	BoxCad: BoxCad	Date 12/9/2021
Material Matière	12 Ga Cold Rolled A1008 CS Type B (2.5mm)	
Color Couleur	Asa-61 Grey	Finish Fini Smooth
Description	9500 72" x 36" x 24" Body	
Part Number Numéro Pièce	Rev. 0	2
<b>9500ST723624B</b>		2

This drawing is confidential and must not be reproduced or used without the consent of EXM

Ce dessin est confidentiel et ne doit pas être reproduit ou utilisé sans le consentement de EXM



TOP

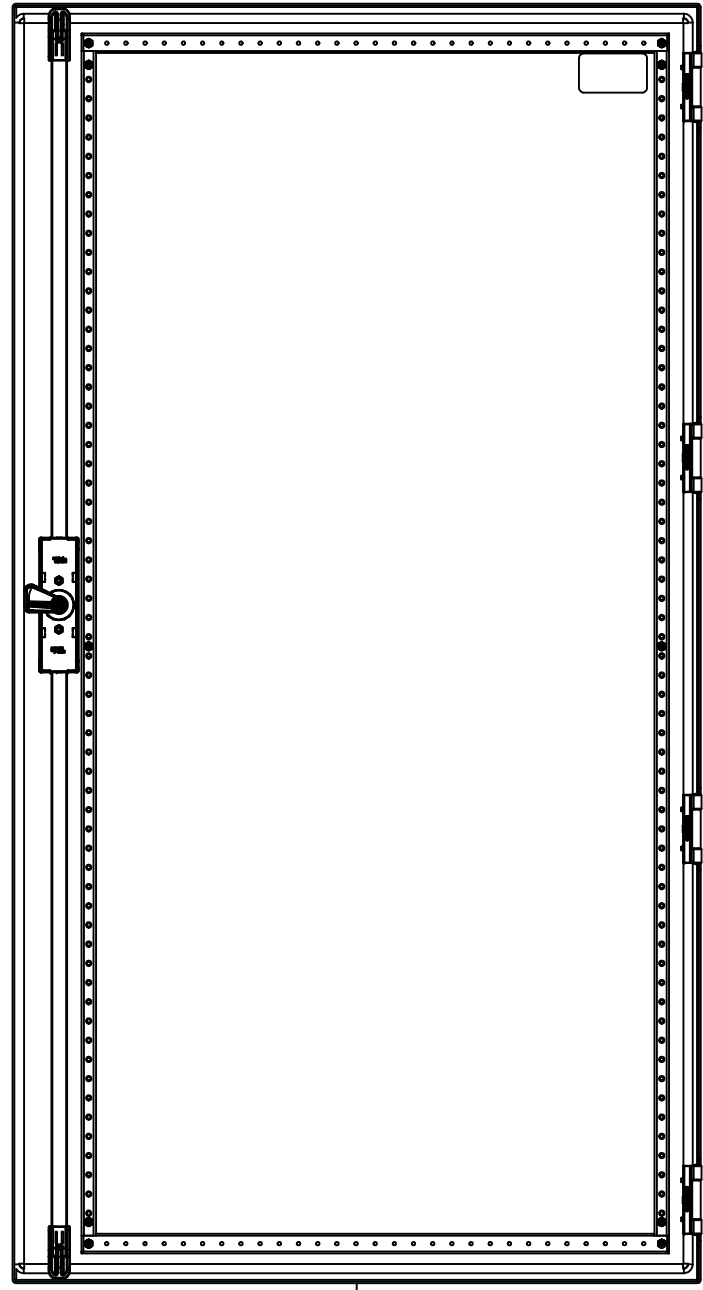

BACK



BOTTOM

0.000  
0.835

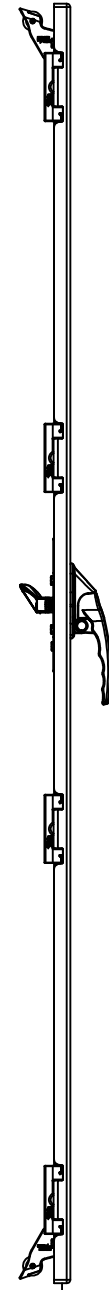

LEFT

0.000

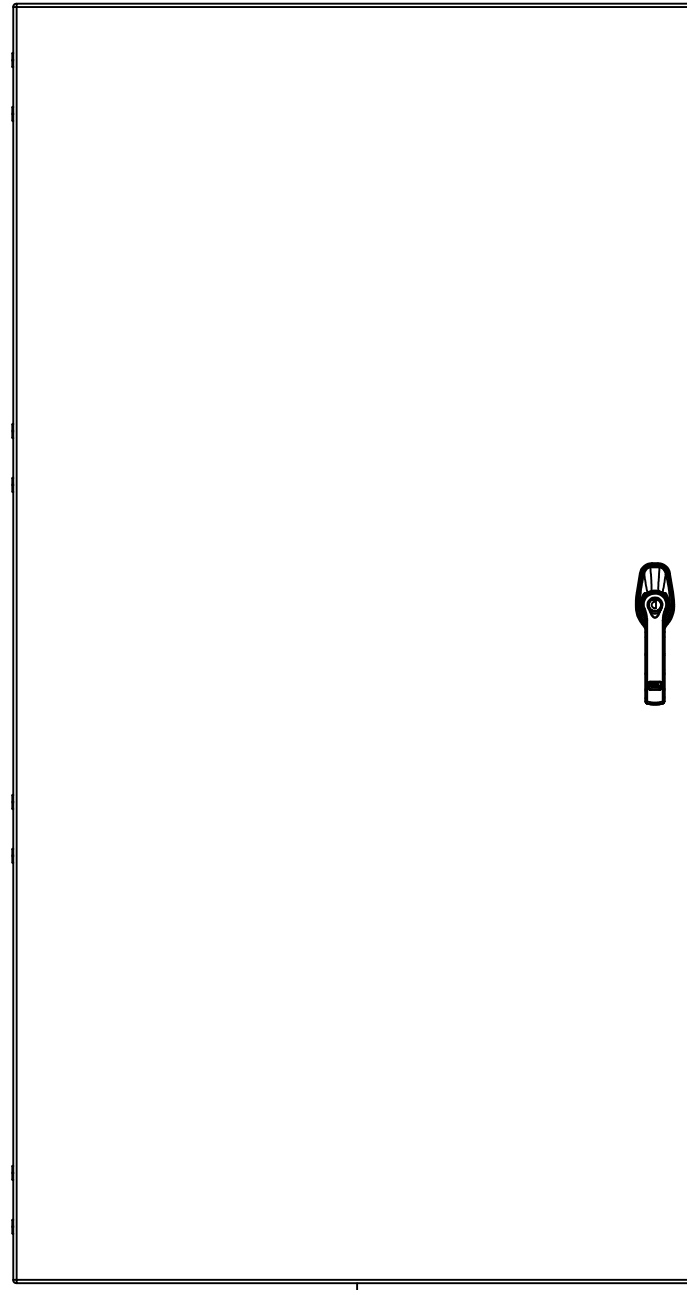

FRONT

35.312

65.549

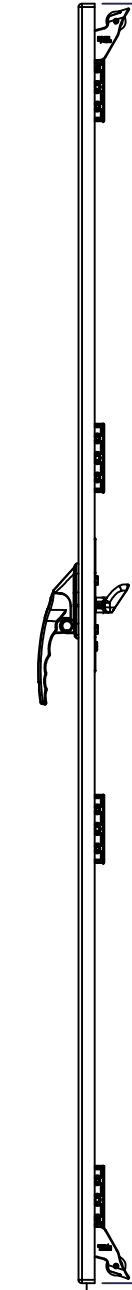

RIGHT

0.000

No.	Revisions	Date	By/Par

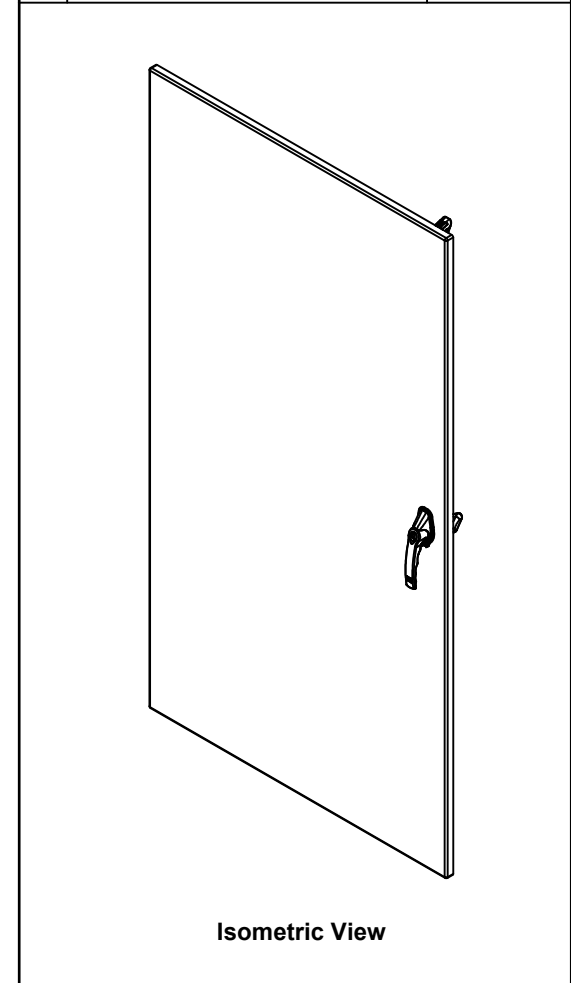

Isometric View

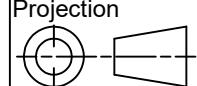

 Tél: (450) 979-4373 Fax: (450) 979-4626 <a href="http://www.exmweb.com">www.exmweb.com</a>		Flatness Aplatissement Max 3.0mm Projection 
Customer Client		Date
Drawn By Dessiné Par	BoxCad: BoxCad	Date 12/9/2021
Material Matière	12 Ga Cold Rolled A1008 CS Type B (2.5mm)	
Color Couleur	Asa-61 Grey	Finish Fini Smooth
Description	9500 72" x 36" Cover	
Part Number Numéro Pièce	Rev. 0	1 / 3

SEE BILL OF MATERIAL ON LAST PAGE

**9500ST723624C**

This drawing is confidential and must not be reproduced or used without the consent of EXM

Ce dessin est confidentiel et ne doit pas être reproduit ou utilisé sans le consentement de EXM

**STANDARD FEATURES ARE NOT LISTED IN THIS HOLE TABLE**

**HOLE TABLE - FRONT VIEW (CUSTOM FEATURE ONLY)**

CUT-OUT	XDIM	YDIM	DESCRIPTION
1	2.000	2.028	STUD M6 x 18mm (Inside)
2	2.000	32.628	STUD M6 x 18mm (Inside)
3	2.000	63.521	STUD M6 x 18mm (Inside)
4	31.407	2.028	STUD M6 x 18mm (Inside)
5	31.407	32.628	STUD M6 x 18mm (Inside)
6	31.407	63.521	STUD M6 x 18mm (Inside)
7	2.000	3.139	STUD M6 x 18mm (Inside)
8	2.000	62.409	STUD M6 x 18mm (Inside)
9	31.407	3.139	STUD M6 x 18mm (Inside)
10	31.407	62.409	STUD M6 x 18mm (Inside)
11	32.937	6.118	STUD M6 x 18mm (Inside)
12	32.937	59.430	STUD M6 x 18mm (Inside)
-----	-----	-----	-----
13	32.937	34.743	HANDLE 885 ESL2A-APHK @ 0.0°

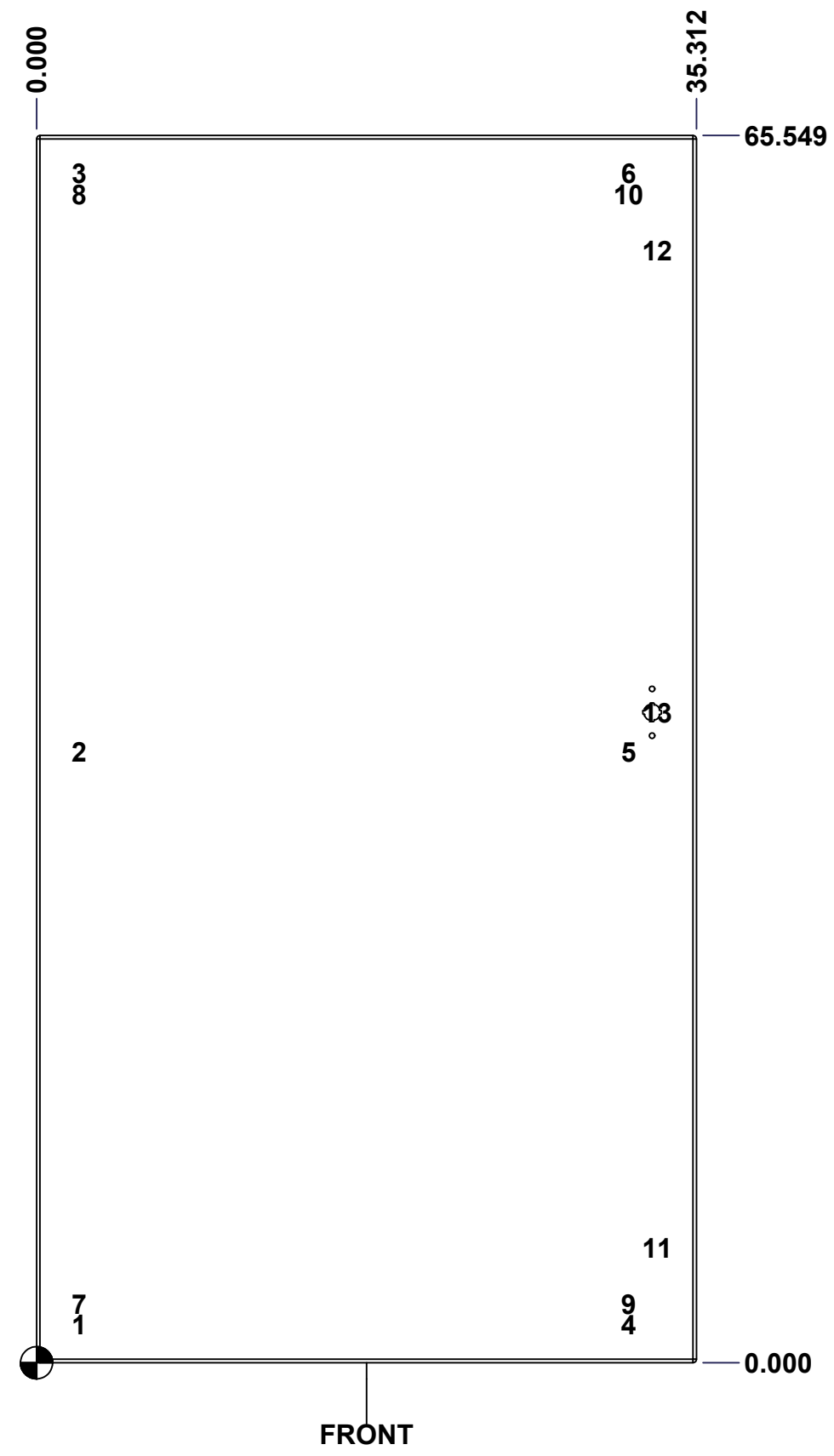

	Description	Status
	9500 72" x 36" Cover	(NULL)
	Part Number Numéro Pièce	Rev.
	<b>9500ST723624C</b>	<b>0</b>
		2
		3

This drawing is confidential and must not be reproduced or used without the consent of EXM

Ce dessin est confidentiel et ne doit pas être reproduit ou utilisé sans le consentement de EXM

No.	Revisions	Date	By/Par

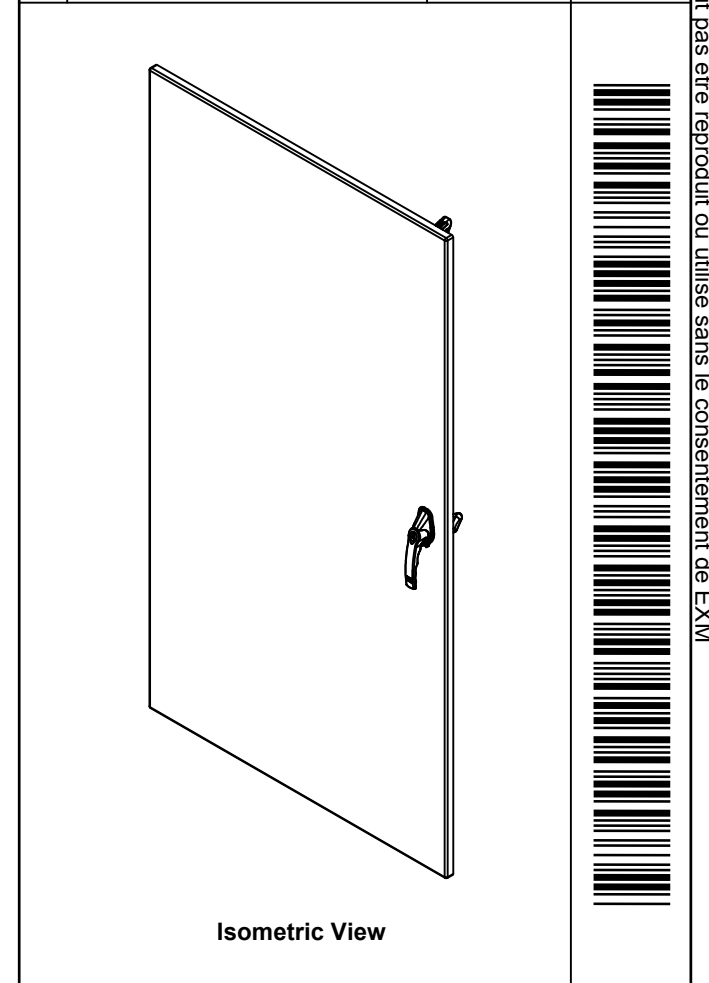

1	STK-Q-47527	1	9500 Lower Closing Bar 72"
1	STK-Q-47517	1	9500 Upper Closing Bar 72"
1	STK-A-03886-36	2	Gearbox Clockwise Assembly (36.0mm)
1	885ESL2A-APHK	6	885 ESL2A-APHK - Zinc Die Cast L-Handle Padlockable Assy
1	STK-P-02400S	0	Powder Paint (Asa-61 Grey / Smooth)
1	STK-S-00100	0	3.5" x 2" Silver Milar Flexcon Sticker
1	9500ST723624G	0	9500 72" x 36" Cover Gasket
1	STK-K-10850	3	9500 - Door Stiffener Assembly
2	STK-Q-16410	0	Guide Stud - Largel (No Paint Cap Required)
10	STK-Q-16055	1	M6 x 18mm Stud (No Paint Cap Required)
1	9500ST723624C-P	0	9500 72" x 36" Cover Part
4	STK-K-09860	7	Cabinet Hinge with Captive Pins
2	STK-A-90025	0	9500 - Cabinet Closing Bar End (Large)
Qty	Part Name	Rev	Description
Parts List			

Tél: (450) 979-4373 Fax: (450) 979-4626 <a href="http://www.exmweb.com">www.exmweb.com</a>	Flatness Aplatissement	Max 3.0mm
	Projection	
Customer Client	Date	
Drawn By Dessiné Par	BoxCad: BoxCad	Date 12/9/2021
Material Matière	12 Ga Cold Rolled A1008 CS Type B (2.5mm)	
Color Couleur	Asa-61 Grey	Finish Fini Smooth
Description	Detail Rev.	
9500 72" x 36" Cover		
Part Number Numéro Pièce	Rev. 0	3
<b>9500ST723624C</b>		3