

This drawing is confidential and must not be reproduced or used without the consent of EXM

Ce dessin est confidentiel et ne doit pas être reproduit ou utilisé sans le consentement de EXM

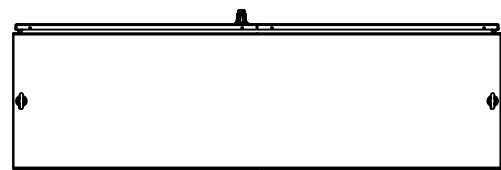

TOP

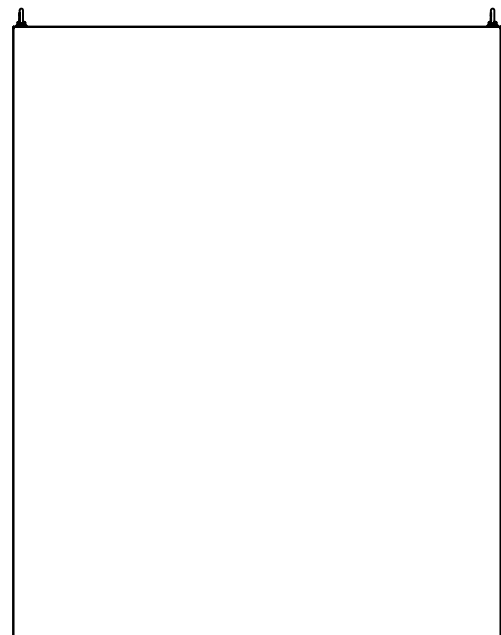

BACK

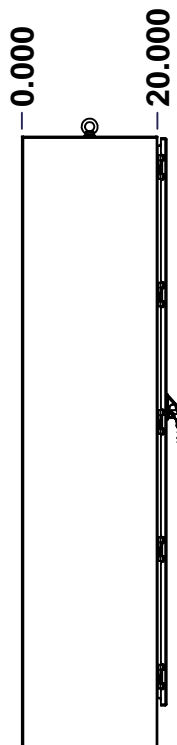

LEFT

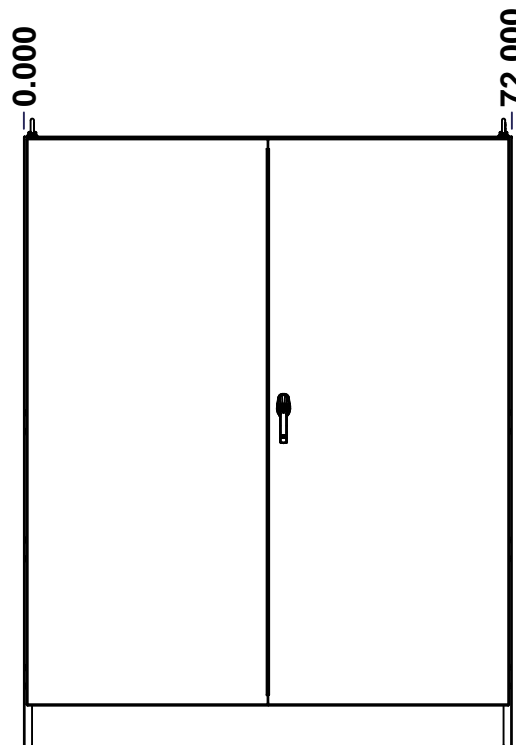

FRONT

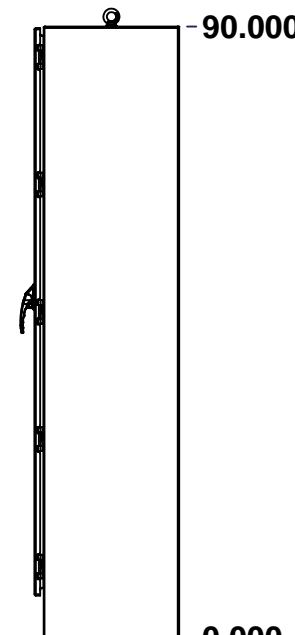

RIGHT

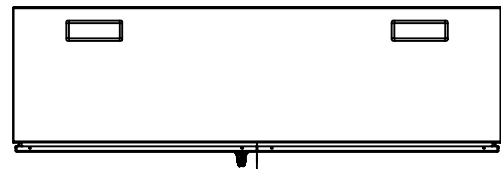

BOTTOM

No.	Revisions	Date	By/Par

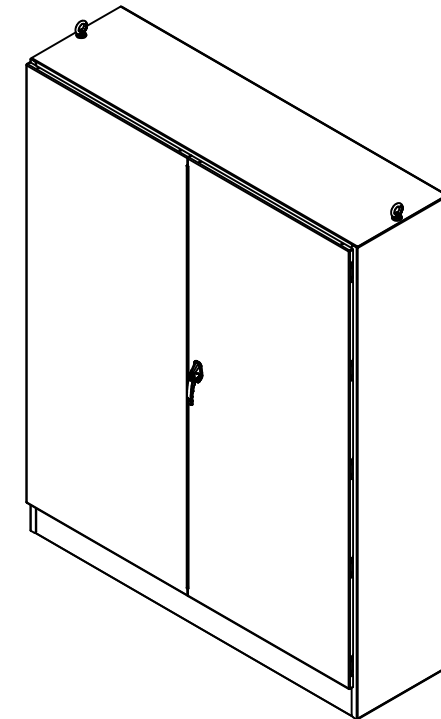

Isometric View



Tél: (450) 979-4373
 Fax: (450) 979-4626
www.exmweb.com

Flatness
Aplatissement
Max 3.0mm
Projection

Customer Client
 Drawn By Dessiné Par BoxCad: BoxCad
 Date 08-Dec-21

Material Matière 12 Ga Cold Rolled A1008 CS Type B (2.5mm)

Color Couleur Asa-61 Grey
 Finish Fini Smooth

Description 9500DD 90" x 72" x 20" Assembly
 Detail Rev.

Part Number Numéro Pièce 9500STDD907220
 Rev. 0

SEE BILL OF MATERIAL ON LAST PAGE

1	2
---	---

This drawing is confidential and must not be reproduced or used without the consent of EXM

Ce dessin est confidentiel et ne doit pas être reproduit ou utilisé sans le consentement de EXM

NOTE	
ITEM	DESCRIPTION
1	NEMA 12/13 Enclosure
2	C/W Standard ground studs on box and cover
3	C/W Standard door stiffener
4	W/O Inner panel
5	C/W Standard inner panel mounting studs
6	C/W Struts installed (Included)
7	C/W Eyebolts

No.	Revisions	Date	By/Par

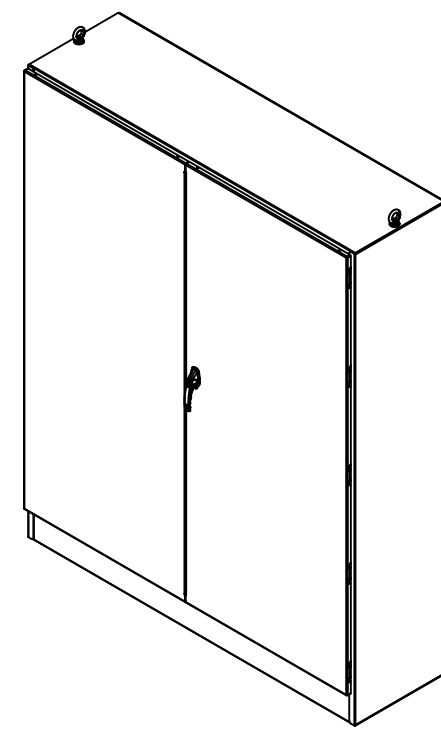

Isometric View

PACKING		
ITEM	QTY	DESCRIPTION
Cardboard sleeve	2	Top and Bottom
Cardboard strip	2	Between back of enclosure and inner panel
Plastic bag	1	To protect cover surface and inside gasket
Cardboard corner	4	To reinforced for the plastic strap tightening
Plastic strap - Black	2	To Squeeze 2 cardboard sleeve together
Packaging label	3	White label with PN
Plastic strap- Green	2	To secure the enclosure to the wood pallet
Wood Pallet	1	2" deeper and 3" larger than enclosure size

Qty	Part Number	Rev	Description
1	880EB14	2	Eye Bolt M14 (Pack of 2)
1	9500STDD907220FD	0	9500DD 90" x 72" Flange Door
1	9500STDD907220LD	0	9500DD 90" x 72" Lock Door
1	9500STDD907220B	0	9500DD 90" x 72" x 20" Body
2	9500STDD907220GP	0	9500DD Gland Plate
10	STK-Q-04050-10	8	M6 x 10mm Hexagon Socket Head Machine Screw with Nyseal
Parts List			

		Tél: (450) 979-4373 Fax: (450) 979-4626 www.exmweb.com		Flatness Aplatissement Max 3.0mm Projection 	
Customer Client		Date		Date 08-Dec-21	
Drawn By Dessiné Par BoxCad: BoxCad		Material Matière 12 Ga Cold Rolled A1008 CS Type B (2.5mm)		Color Couleur Asa-61 Grey	
Finish Fini Smooth		Description 9500DD 90" x 72" x 20" Assembly		Detail Rev.	
Part Number Numéro Pièce 9500STDD907220		Rev. 0		2	

This drawing is confidential and must not be reproduced or used without the consent of EXM

Ce dessin est confidentiel et ne doit pas être reproduit ou utilisé sans le consentement de EXM

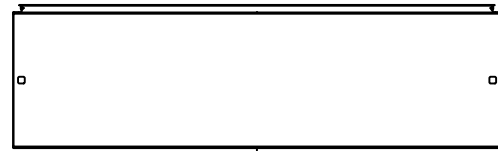

TOP

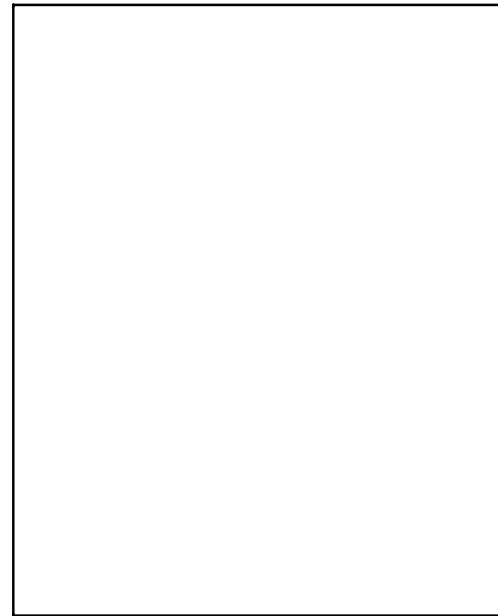

BACK

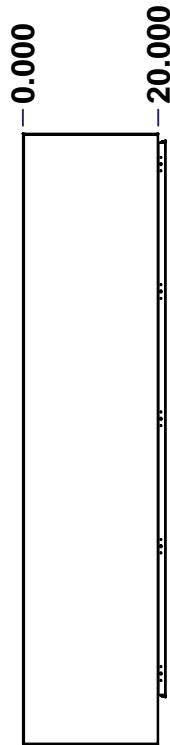

LEFT

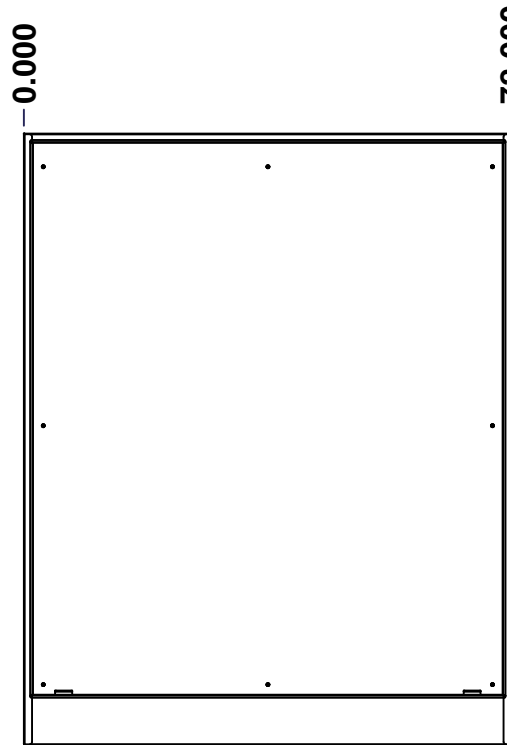

FRONT

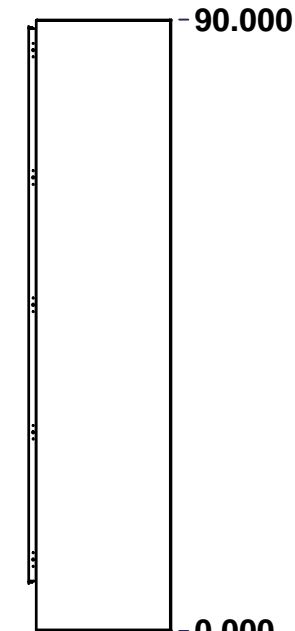

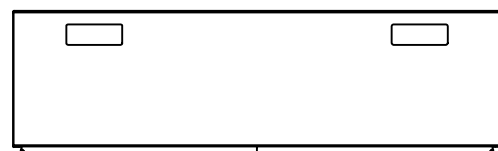

RIGHT

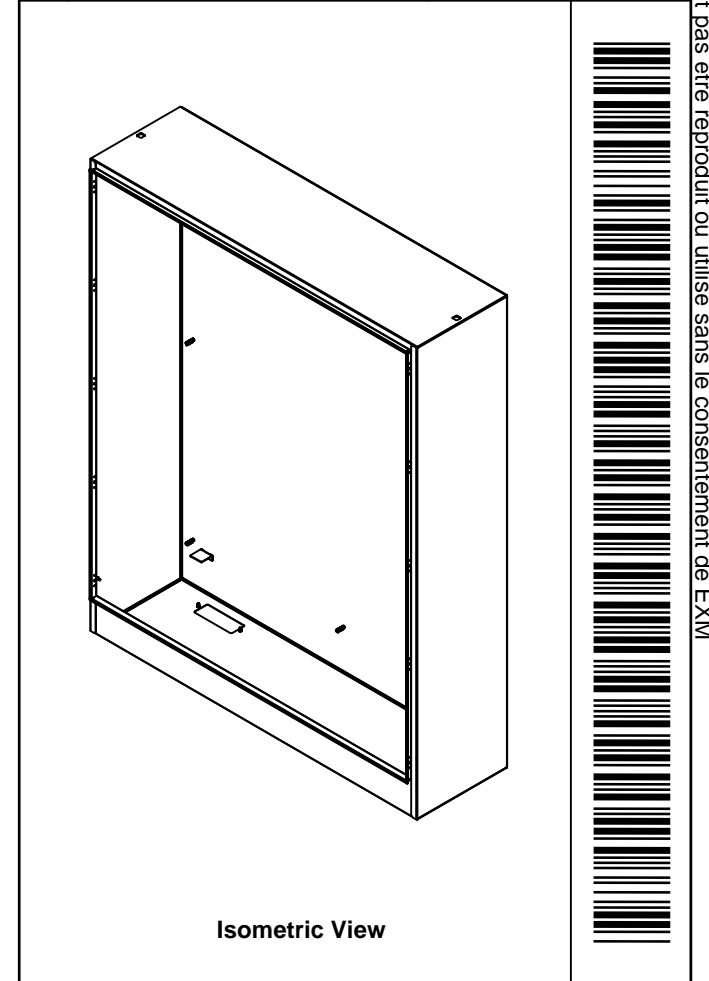

BOTTOM

No.	Revisions	Date	By/Par

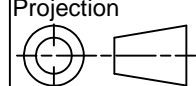

 Tél: (450) 979-4373 Fax: (450) 979-4626 www.exmweb.com		Flatness Aplatissement Max 3.0mm Projection 
Customer Client	Date	
Drawn By Dessiné Par	BoxCad: BoxCad	Date 08-Dec-21
Material Matière	12 Ga Cold Rolled A1008 CS Type B (2.5mm)	
Color Couleur	Asa-61 Grey	Finish Finis Smooth
Description 9500DD 90" x 72" x 20" Body		Detail Rev.
Part Number Numéro Pièce	9500STDD907220B	Rev. 1 0

SEE BILL OF MATERIAL ON LAST PAGE

This drawing is confidential and must not be reproduced or used without the consent of EXM

Ce dessin est confidentiel et ne doit pas être reproduit ou utilisé sans le consentement de EXM

STANDARD FEATURES ARE NOT LISTED IN THIS HOLE TABLE

HOLE TABLE - TOP VIEW (CUSTOM FEATURE ONLY)

CUT-OUT	XDIM	YDIM	DESCRIPTION
1	53.911	15.911	Struts CR400 27.500" (Inside)
2	17.911	15.911	Struts CR400 27.500" (Inside)
3	53.911	15.911	STUDS M6 x 10mm (Inside)
4	43.161	15.911	STUDS M6 x 10mm (Inside)
5	64.661	15.911	STUDS M6 x 10mm (Inside)
6	17.911	15.911	STUDS M6 x 10mm (Inside)
7	7.161	15.911	STUDS M6 x 10mm (Inside)
8	28.661	15.911	STUDS M6 x 10mm (Inside)

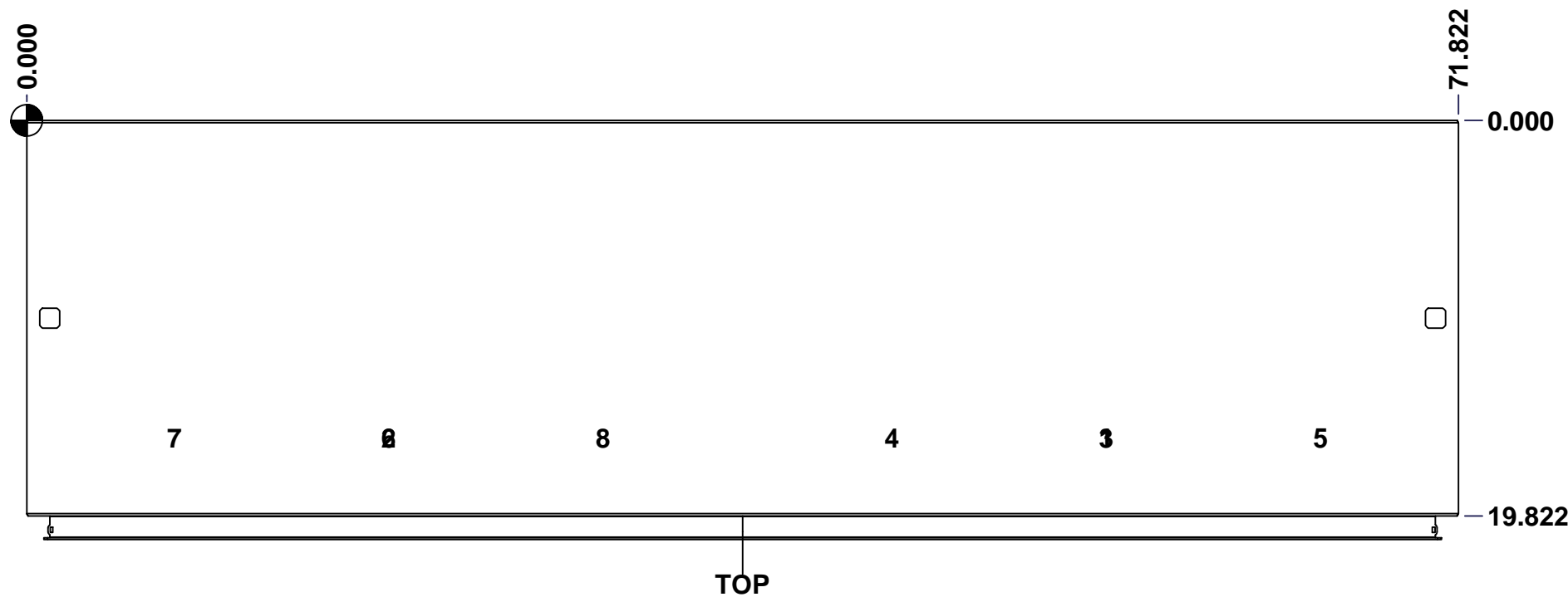

	Description	Status	
	9500DD 90" x 72" x 20" Body	Released	
	Part Number Numéro Pièce	Rev.	
	9500STDD907220B	0	2 / 7

This drawing is confidential and must not be reproduced or used without the consent of EXM

Ce dessin est confidentiel et ne doit pas être reproduit ou utilisé sans le consentement de EXM

STANDARD FEATURES ARE NOT LISTED IN THIS HOLE TABLE			
HOLE TABLE - RIGHT VIEW (CUSTOM FEATURE ONLY)			
CUT-OUT	XDIM	YDIM	DESCRIPTION
1	18.411	9.286	GND STUD M6 x 16mm (Inside)

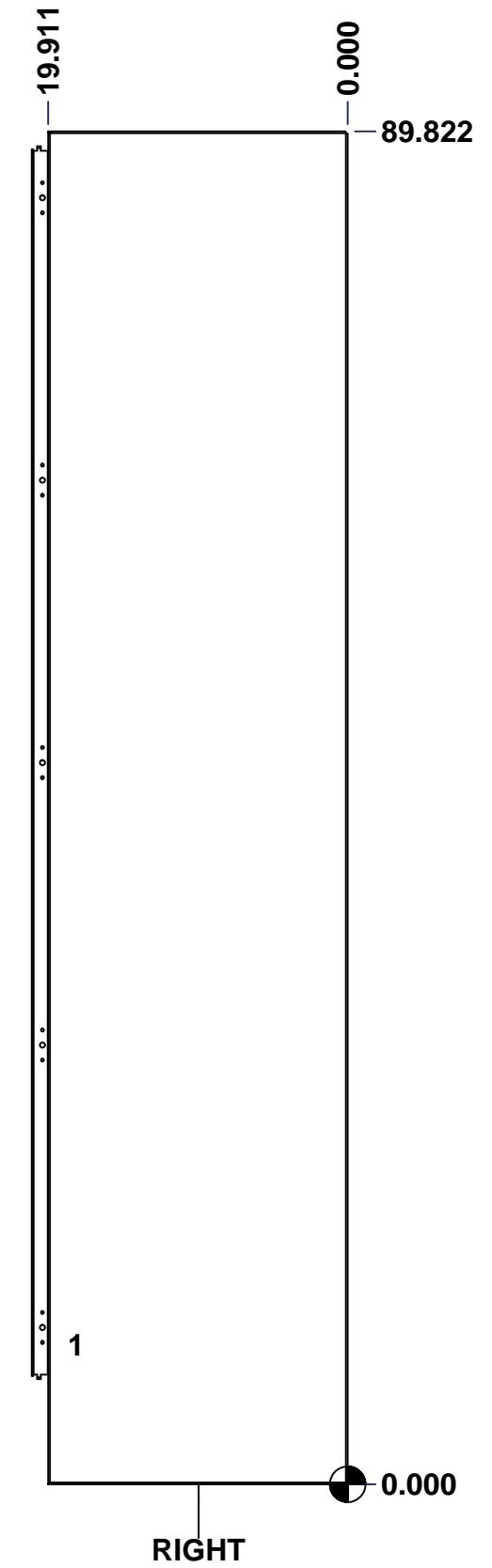

	Description	Status	
	9500DD 90" x 72" x 20" Body	Released	
	Part Number Numéro Pièce	Rev.	
	9500STDD907220B	0	3 / 7

This drawing is confidential and must not be reproduced or used without the consent of EXM

Ce dessin est confidentiel et ne doit pas être reproduit ou utilisé sans le consentement de EXM

STANDARD FEATURES ARE NOT LISTED IN THIS HOLE TABLE			
HOLE TABLE - BOTTOM VIEW (CUSTOM FEATURE ONLY)			
CUT-OUT	XDIM	YDIM	DESCRIPTION
1	7.286	3.411	GP STUD M6 x 16mm (Inside)
2	16.536	3.411	GP STUD M6 x 16mm (Inside)
3	55.286	3.411	GP STUD M6 x 16mm (Inside)
4	64.536	3.411	GP STUD M6 x 16mm (Inside)

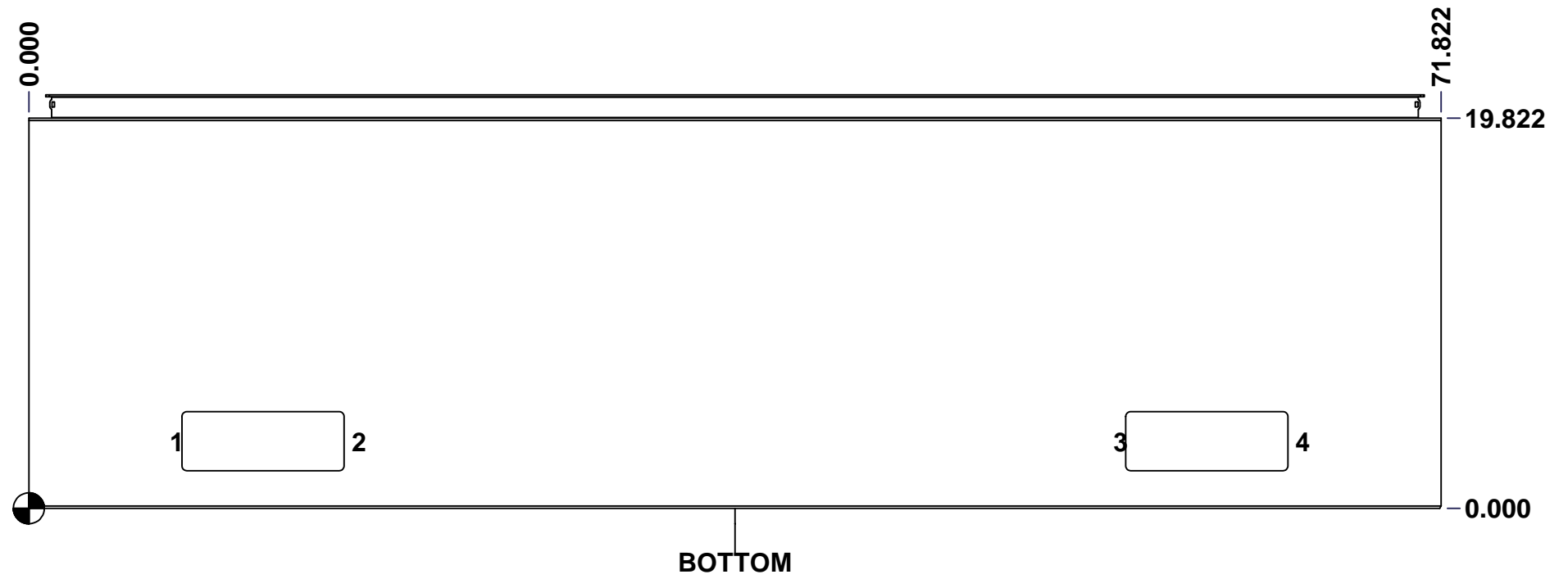

	Description	Status	
	9500DD 90" x 72" x 20" Body	Released	
	Part Number Numéro Pièce	Rev.	
	9500STDD907220B	0	4 / 7

This drawing is confidential and must not be reproduced or used without the consent of EXM

Ce dessin est confidentiel et ne doit pas être reproduit ou utilisé sans le consentement de EXM

STANDARD FEATURES ARE NOT LISTED IN THIS HOLE TABLE			
HOLE TABLE - LEFT VIEW (CUSTOM FEATURE ONLY)			
CUT-OUT	XDIM	YDIM	DESCRIPTION
1	18.411	9.286	GND STUD M6 x 16mm (Inside)

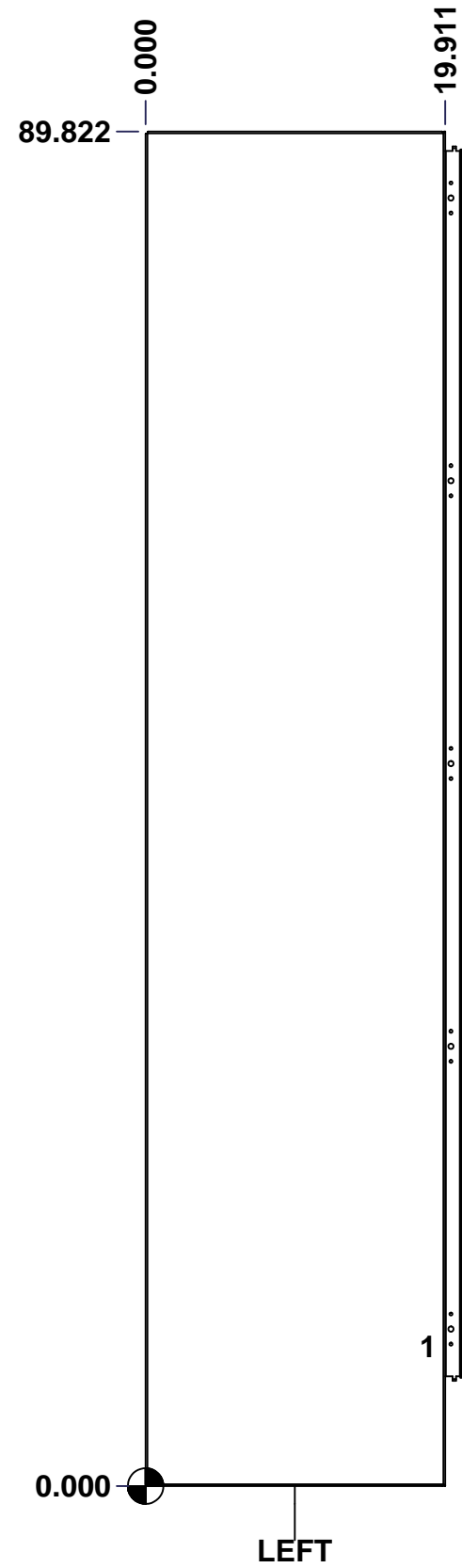

	Description	Status	
	9500DD 90" x 72" x 20" Body	Released	
	Part Number Numéro Pièce	Rev.	
	9500STDD907220B	0	5 / 7

This drawing is confidential and must not be reproduced or used without the consent of EXM

Ce dessin est confidentiel et ne doit pas être reproduit ou utilisé sans le consentement de EXM

STANDARD FEATURES ARE NOT LISTED IN THIS HOLE TABLE

HOLE TABLE - BACK VIEW (CUSTOM FEATURE ONLY)

CUT-OUT	XDIM	YDIM	DESCRIPTION
1	2.786	8.786	IP STUD M10 x 40mm (Inside)
2	69.036	8.786	IP STUD M10 x 40mm (Inside)
3	2.786	46.911	IP STUD M10 x 40mm (Inside)
4	69.036	46.911	IP STUD M10 x 40mm (Inside)
5	2.786	85.036	IP STUD M10 x 40mm (Inside)
6	69.036	85.036	IP STUD M10 x 40mm (Inside)
7	35.911	8.786	IP STUD M10 x 40mm (Inside)
8	35.911	85.036	IP STUD M10 x 40mm (Inside)
-----	-----	-----	-----
9	5.786	7.411	IP SUPPORT ANGLE (Inside)
10	66.036	7.411	IP SUPPORT ANGLE (Inside)

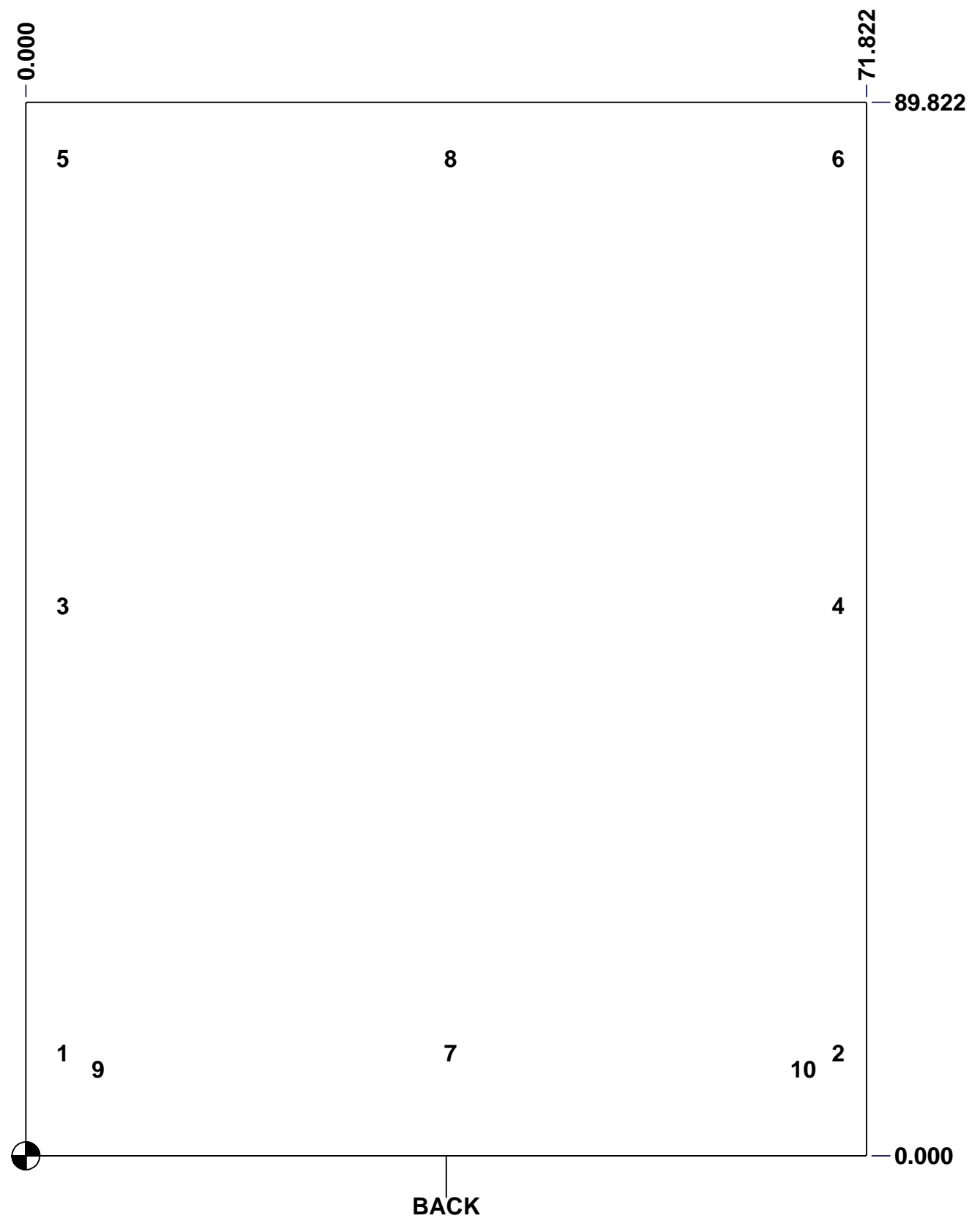

	Description	Status
	9500DD 90" x 72" x 20" Body	Released
	Part Number Numéro Pièce	Rev.
	9500STDD907220B	0
		6
		7

This drawing is confidential and must not be reproduced or used without the consent of EXM

Ce dessin est confidentiel et ne doit pas être reproduit ou utilisé sans le consentement de EXM

No.	Revisions	Date	By/Par

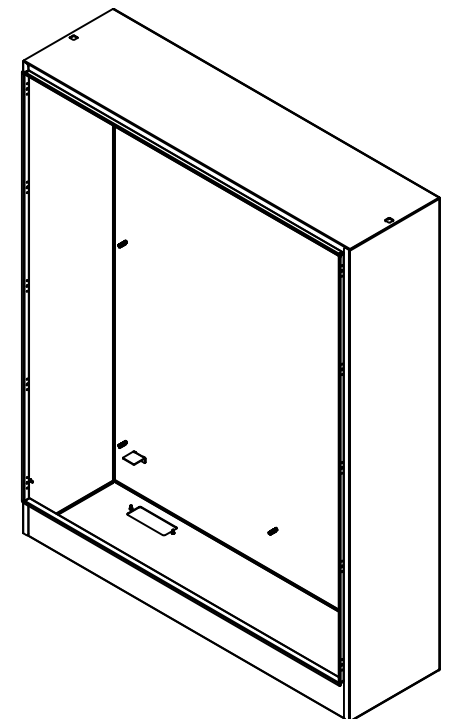

Isometric View



Qty	Part Number	Rev	Description
6	STK-Q-16030	0	Stud M6 x 10mm
2	9500STDD907220BPA-P	0	9500DD Inner Panel Support Angle
6	STK-Q-07220	1	M6 Nylon Insert Lock Nut
1	STK-P-02400S	0	Powder Paint (Asa-61 Grey / Smooth)
8	STK-Q-16100	0	Stud M10 x 40mm
1	9500STDD907220BT-P	0	9500DD 72" x 20" Bottom Part
1	9500STDD907220T-P	0	9500DD 72" x 20" Top Part
1	9500STDD907220RS-P	0	9500DD 90" x 72" Right Part
1	9500STDD907220LS-P	0	9500DD 90" x 72" Left Part
1	9500STDD907220B-P	0	9500DD 90" x 72" Back Part
2	CR400MS_27.5	0	Commercial Roll Mild Steel (27.5in long)
6	STK-Q-16080	0	Ground Stud M6 x 16mm
Parts List			

Tél: (450) 979-4373 Fax: (450) 979-4626 www.exmweb.com		Flatness Aplatissement Max 3.0mm Projection
Customer Client	Date	
Drawn By Dessiné Par	BoxCad: BoxCad	Date 08-Dec-21
Material Matière	12 Ga Cold Rolled A1008 CS Type B (2.5mm)	
Color Couleur	Asa-61 Grey	Finish Fini Smooth
Description	9500DD 90" x 72" x 20" Body	
Part Number Numéro Pièce	Rev. 0	2
9500STDD907220B		2

This drawing is confidential and must not be reproduced or used without the consent of EXM

Ce dessin est confidentiel et ne doit pas être reproduit ou utilisé sans le consentement de EXM

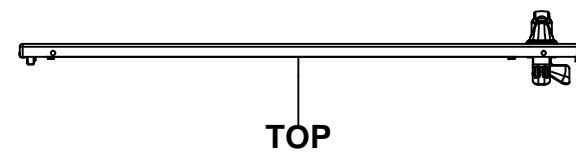

TOP

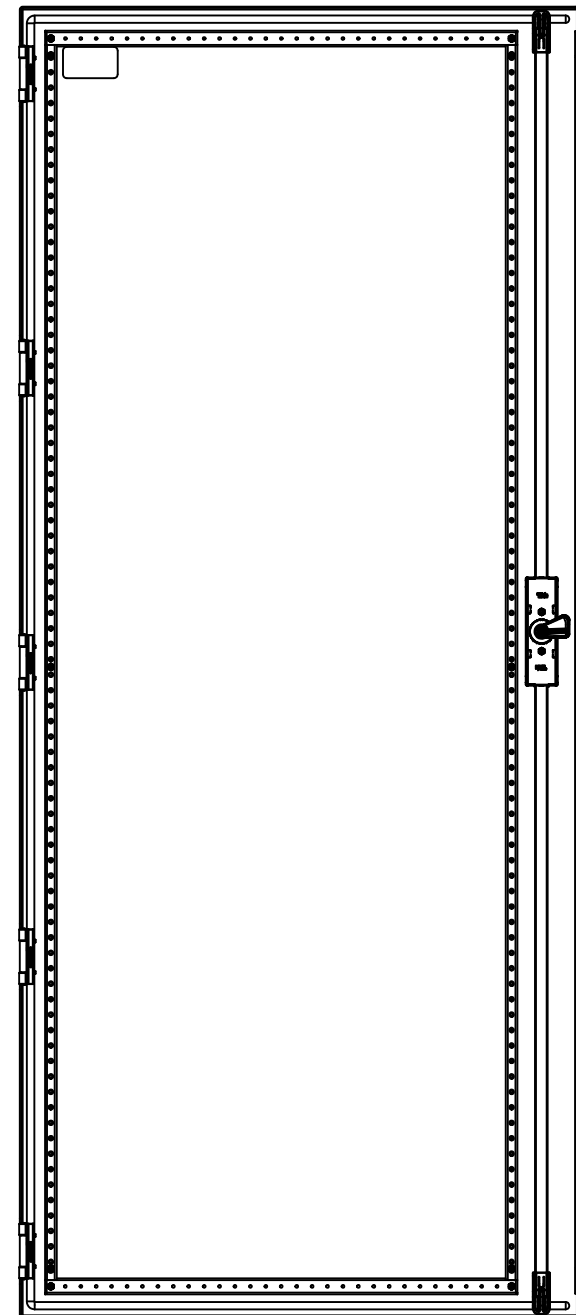

BACK



BOTTOM

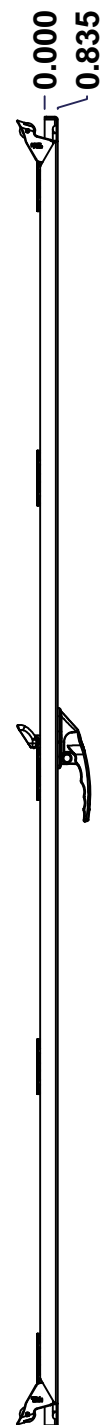

LEFT

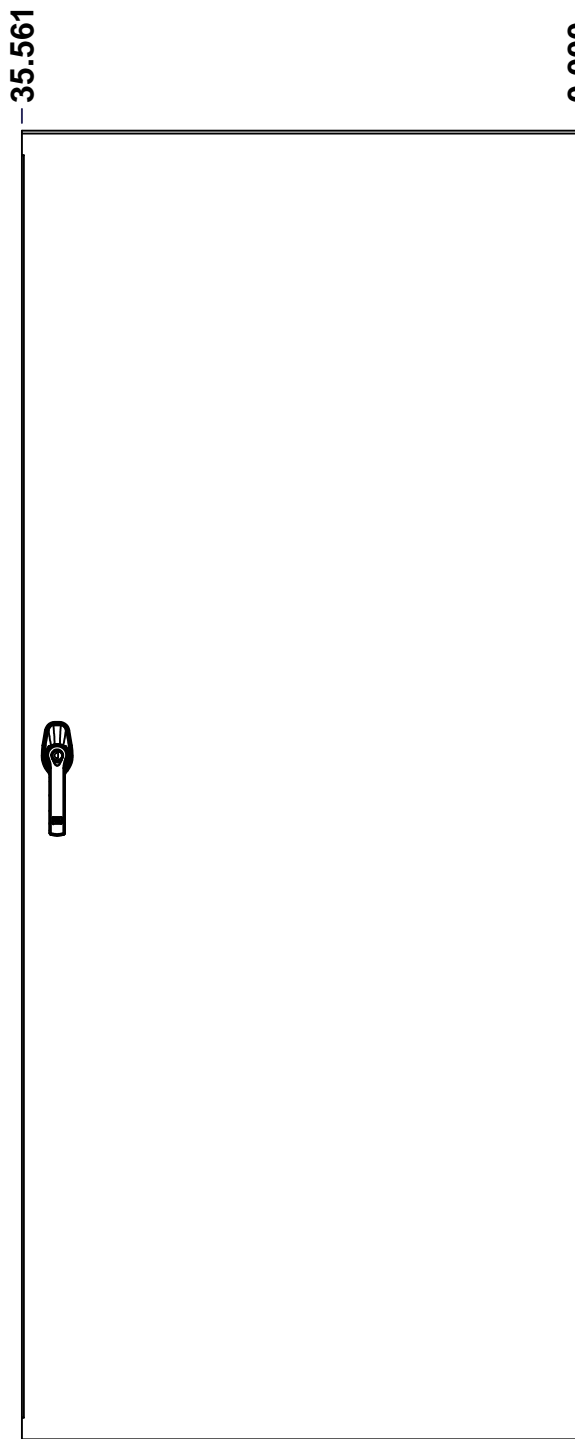

FRONT

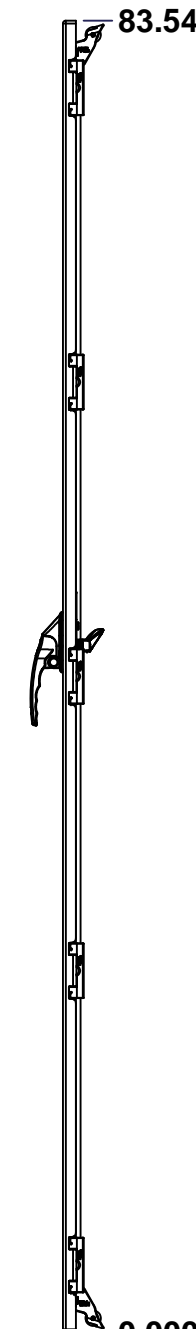

RIGHT

0.000
0.835

35.561

0.000

83.549

0.000

No.	Revisions	Date	By/Par

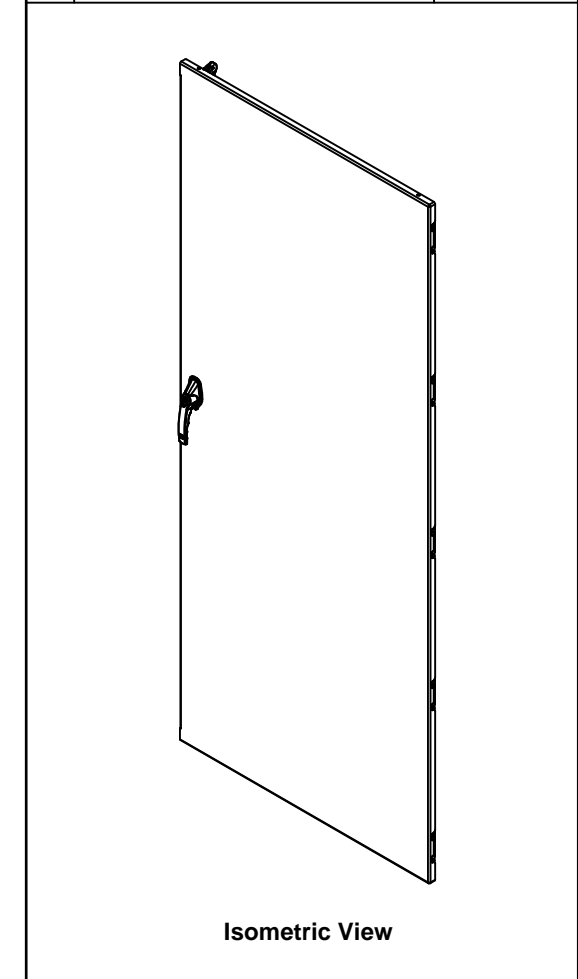

Isometric View



Tél: (450) 979-4373
Fax: (450) 979-4626
www.exmweb.com

Flatness
Aplatissement

Max 3.0mm

Projection

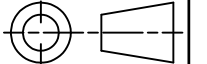

Customer Client	Date
Drawn By Dessiné Par BoxCad: BoxCad	Date 08-Dec-21
Material Matière 12 Ga Cold Rolled A1008 CS Type B (2.5mm)	
Color Couleur Asa-61 Grey	Finish Fini Smooth
Description 9500DD 90" x 72" Lock Door	Detail Rev.
Part Number Numéro Pièce 9500STDD907220LD	Rev. 1 0 3

SEE BILL OF MATERIAL ON LAST PAGE

This drawing is confidential and must not be reproduced or used without the consent of EXM

Ce dessin est confidentiel et ne doit pas être reproduit ou utilisé sans le consentement de EXM

STANDARD FEATURES ARE NOT LISTED IN THIS HOLE TABLE

HOLE TABLE - FRONT VIEW (CUSTOM FEATURE ONLY)

CUT-OUT	XDIM	YDIM	DESCRIPTION
1	1.983	2.028	STUD M6 x 18mm (Inside)
2	1.983	41.486	STUD M6 x 18mm (Inside)
3	1.983	81.521	STUD M6 x 18mm (Inside)
4	1.983	3.139	STUD M6 x 18mm (Inside)
5	1.983	80.409	STUD M6 x 18mm (Inside)
6	31.390	2.028	STUD M6 x 18mm (Inside)
7	31.390	41.486	STUD M6 x 18mm (Inside)
8	31.390	81.521	STUD M6 x 18mm (Inside)
9	31.390	3.139	STUD M6 x 18mm (Inside)
10	31.390	80.409	STUD M6 x 18mm (Inside)
11	33.311	6.118	STUD M6 x 18mm (Inside)
12	33.311	77.430	STUD M6 x 18mm (Inside)
-----	-----	-----	-----
13	33.311	43.743	HANDLE 885 ESL2A-APHK @ 0.0°

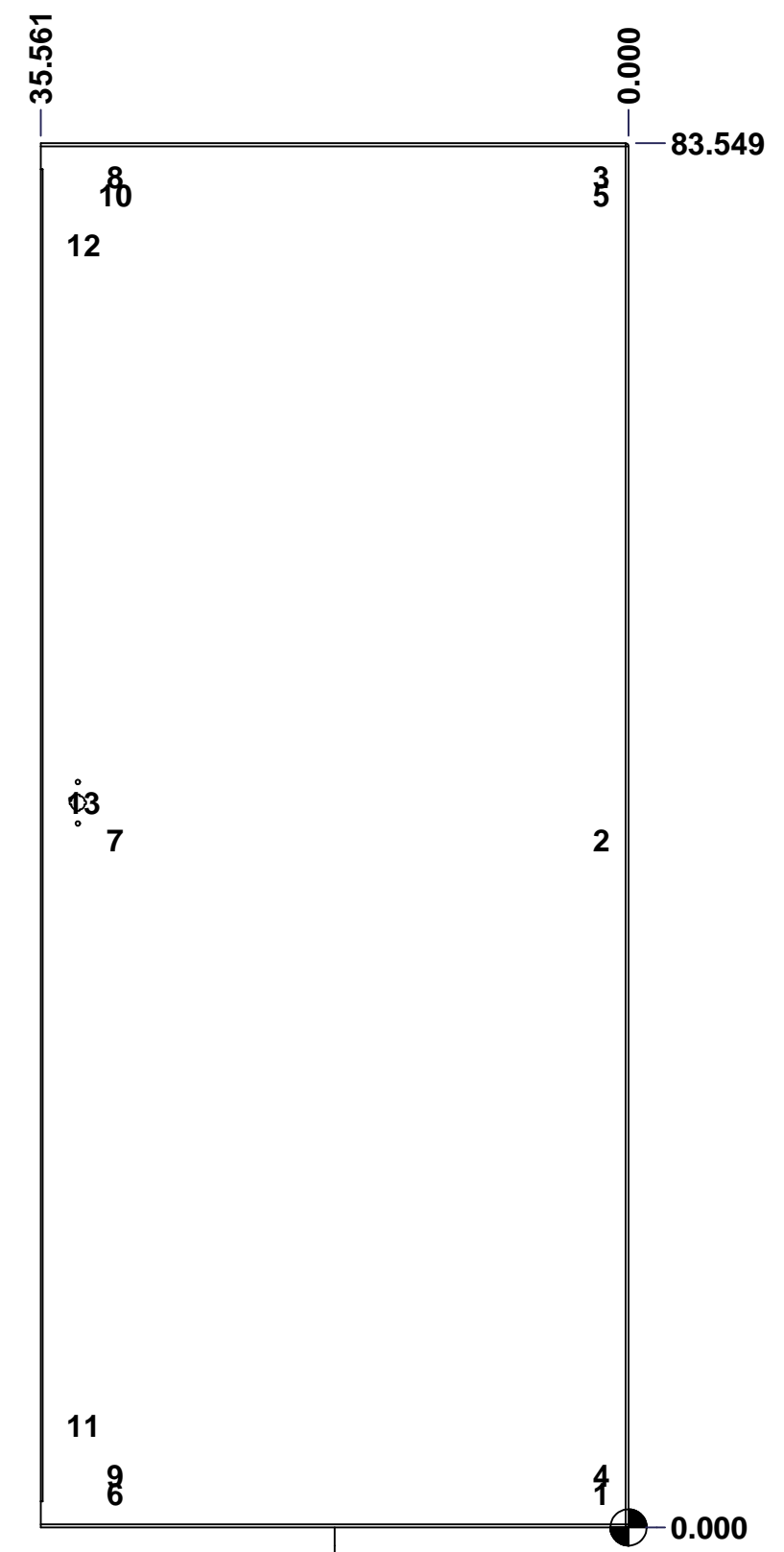

FRONT

	Description	Status
	9500DD 90" x 72" Lock Door	(NULL)
	Part Number Numéro Pièce	Rev.
	9500STDD907220LD	0
		2
		3

This drawing is confidential and must not be reproduced or used without the consent of EXM

Ce dessin est confidentiel et ne doit pas être reproduit ou utilisé sans le consentement de EXM

No.	Revisions	Date	By/Par

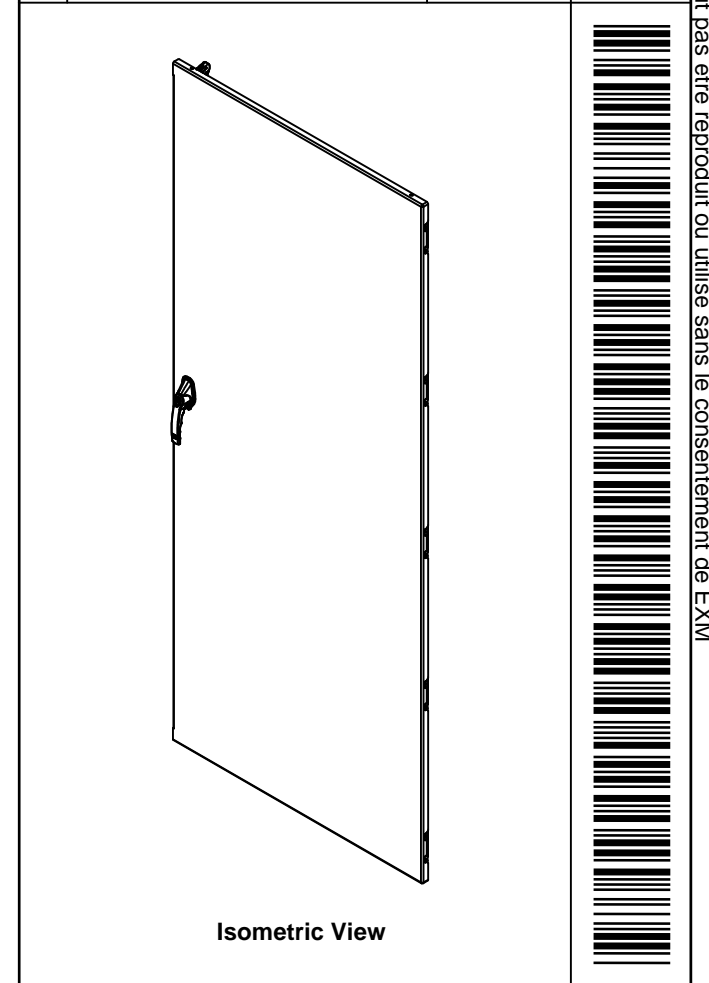

Qty	Part Name	Rev	Description
1	STK-Q-47528	1	9500 Lower Closing Bar 90"
1	STK-Q-47518	1	9500 Upper Closing Bar 90"
1	STK-A-03986-36	2	Gearbox Counterclockwise Assembly (36.0mm)
1	885ESL2A-APHK	6	885 ESL2A-APHK - Zinc Die Cast L-Handle Padlockable Assy
1	STK-P-02400S	0	Powder Paint (Asa-61 Grey / Smooth)
1	STK-S-00100	0	3.5" x 2" Silver Milar Flexcon Sticker
1	STK-K-10880	3	9500 - Door Stiffener Assembly
1	9500STDD907220LDG	0	9500DD 90" x 72" Lock Door Gasket
2	STK-Q-16410	0	Guide Stud - Largel (No Paint Cap Required)
10	STK-Q-16055	1	M6 x 18mm Stud (No Paint Cap Required)
1	9500STDD907220LD-P	0	9500DD 90" x 72" Lock Door Part
5	STK-K-09860	7	Cabinet Hinge with Captive Pins
2	STK-A-90025	0	9500 - Cabinet Closing Bar End (Large)

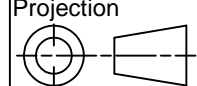
 Tél: (450) 979-4373 Fax: (450) 979-4626 www.exmweb.com		Flatness Aplatissement Max 3.0mm Projection 
Customer Client	Date	Date
Drawn By Dessiné Par	BoxCad: BoxCad	08-Dec-21
Material Matière	12 Ga Cold Rolled A1008 CS Type B (2.5mm)	
Color Couleur	Asa-61 Grey	Finish Fini: Smooth
Description	9500DD 90" x 72" Lock Door	
Part Number Numéro Pièce	Rev.	3
9500STDD907220LD	0	3

Parts List

This drawing is confidential and must not be reproduced or used without the consent of EXM

Ce dessin est confidentiel et ne doit pas être reproduit ou utilisé sans le consentement de EXM



TOP

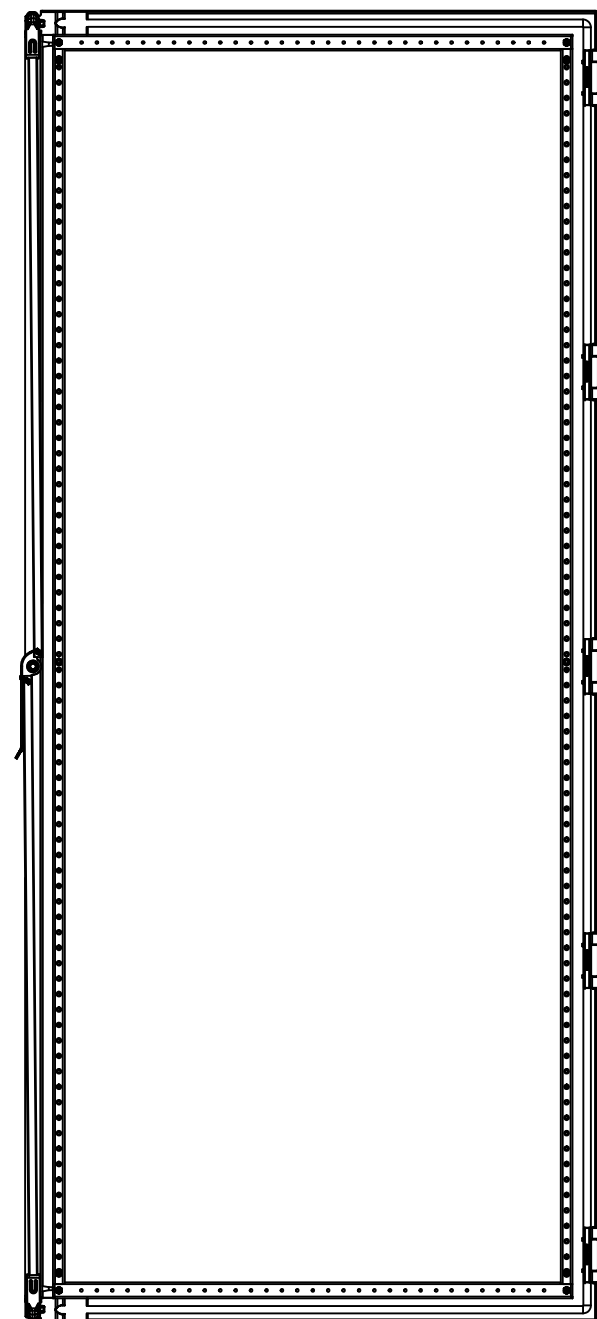

BACK

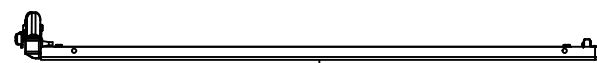

BOTTOM

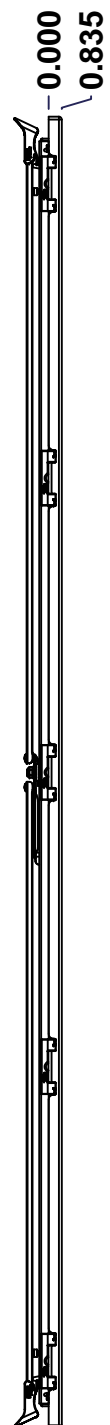

LEFT

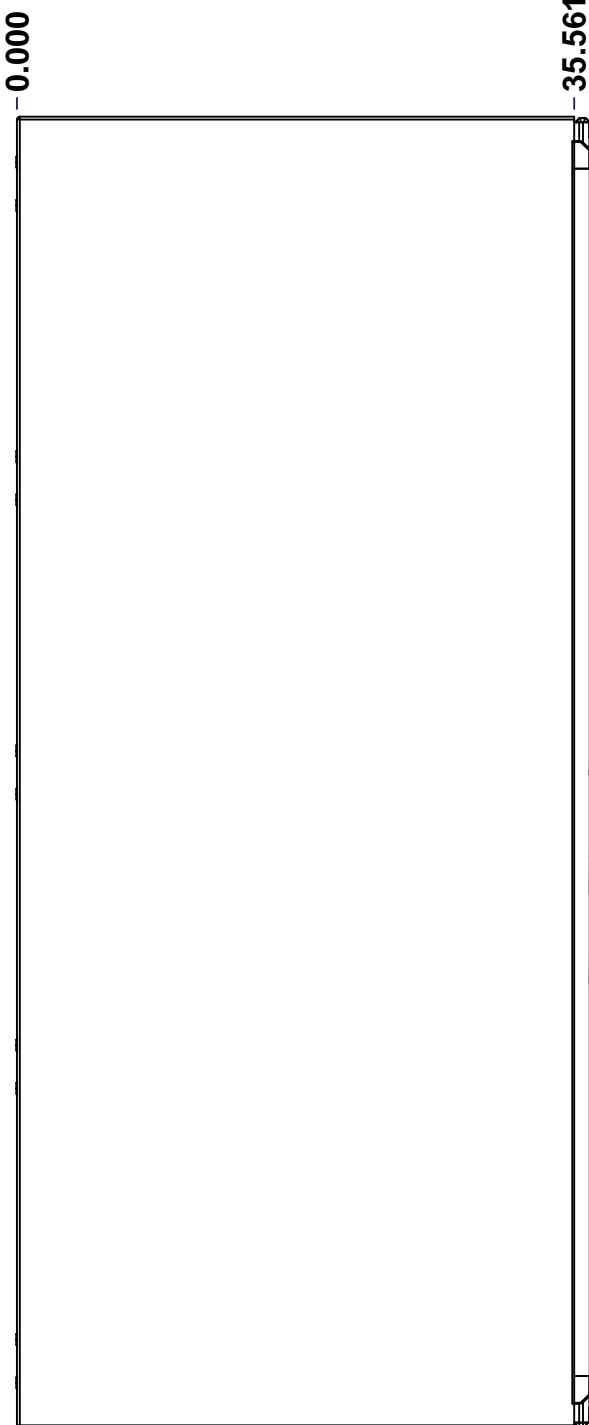

FRONT

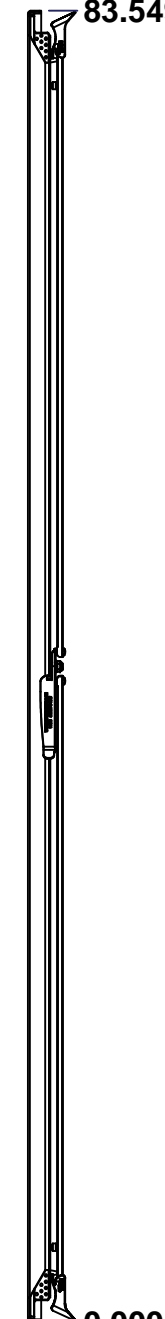

RIGHT

No.	Revisions	Date	By/Par

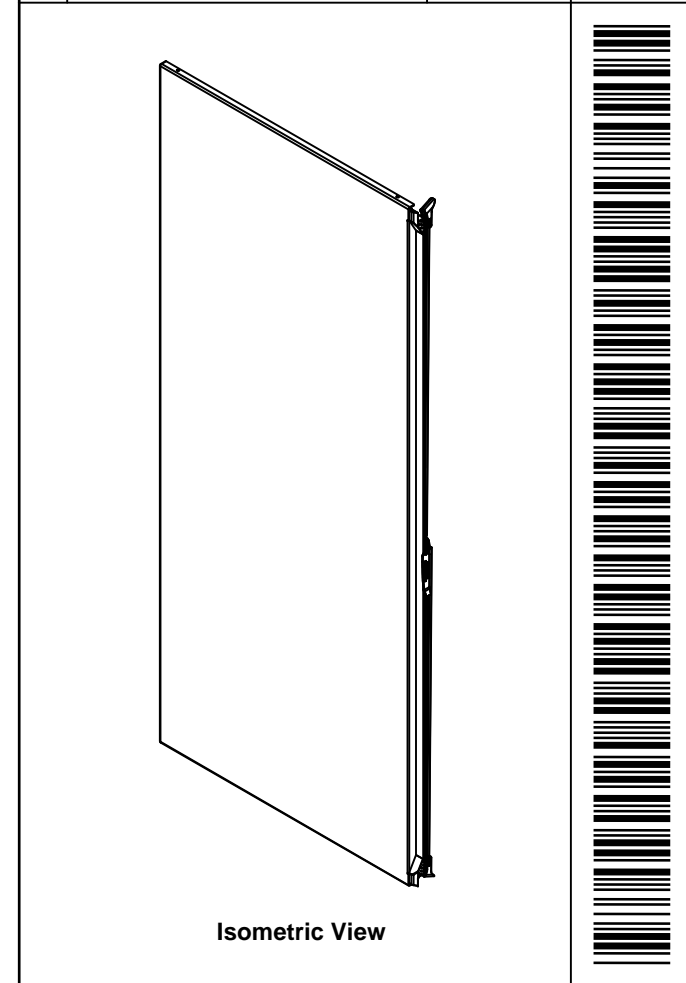

Tél: (450) 979-4373 Fax: (450) 979-4626 www.exmweb.com		Flatness Aplatissement	
		Max 3.0mm	
Customer Client		Date	
Drawn By Dessiné Par BoxCad: BoxCad		Date 08-Dec-21	
Material Matière 12 Ga Cold Rolled A1008 CS Type B (2.5mm)			
Color Couleur Asa-61 Grey		Finish Fini Smooth	
Description 9500DD 90" x 72" Flange Door			Detail Rev.
Part Number Numéro Pièce 9500STDD907220FD		Rev. 0	1 3

SEE BILL OF MATERIAL ON LAST PAGE

This drawing is confidential and must not be reproduced or used without the consent of EXM

Ce dessin est confidentiel et ne doit pas être reproduit ou utilisé sans le consentement de EXM

STANDARD FEATURES ARE NOT LISTED IN THIS HOLE TABLE

HOLE TABLE - FRONT VIEW (CUSTOM FEATURE ONLY)

CUT-OUT	XDIM	YDIM	DESCRIPTION
1	2.000	2.028	STUD M6 x 18mm (Inside)
2	2.000	41.486	STUD M6 x 18mm (Inside)
3	2.000	81.521	STUD M6 x 18mm (Inside)
4	2.000	3.139	STUD M6 x 18mm (Inside)
5	2.000	80.409	STUD M6 x 18mm (Inside)
6	34.407	2.028	STUD M6 x 18mm (Inside)
7	34.407	41.486	STUD M6 x 18mm (Inside)
8	34.407	81.521	STUD M6 x 18mm (Inside)
9	34.407	3.139	STUD M6 x 18mm (Inside)
10	34.407	80.409	STUD M6 x 18mm (Inside)
11	36.061	4.774	CLOSING BAR GUIDE (Inside)
12	36.061	78.774	CLOSING BAR GUIDE (Inside)
13	36.061	41.774	STUD M10 x 20mm (Inside)

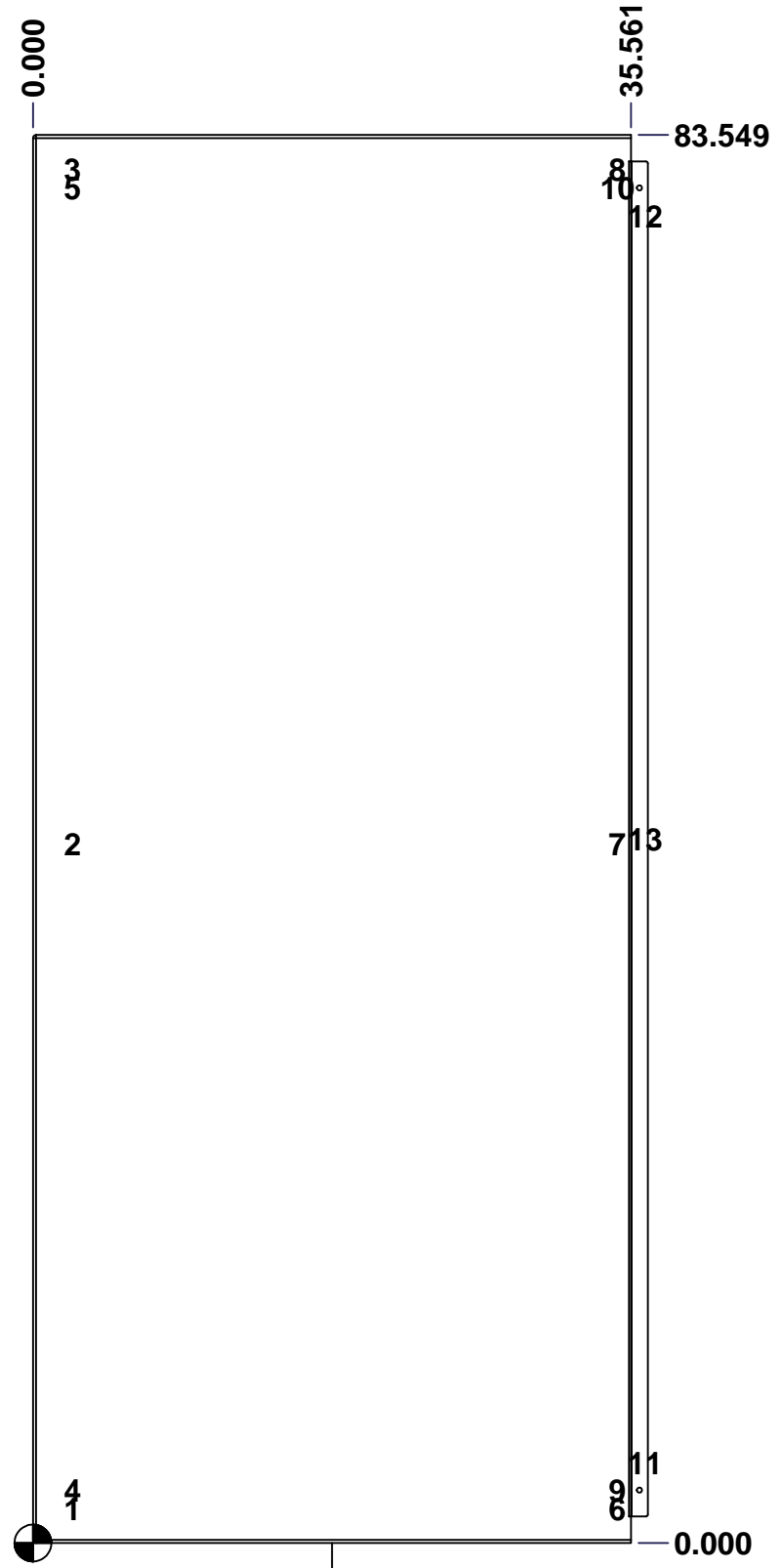

FRONT

	Description	Status
	9500DD 90" x 72" Flange Door	(NULL)
	Part Number Numéro Pièce	Rev.
	9500STDD907220FD	0 / 2 / 3

This drawing is confidential and must not be reproduced or used without the consent of EXM

Ce dessin est confidentiel et ne doit pas être reproduit ou utilisé sans le consentement de EXM

No.	Revisions	Date	By/Par

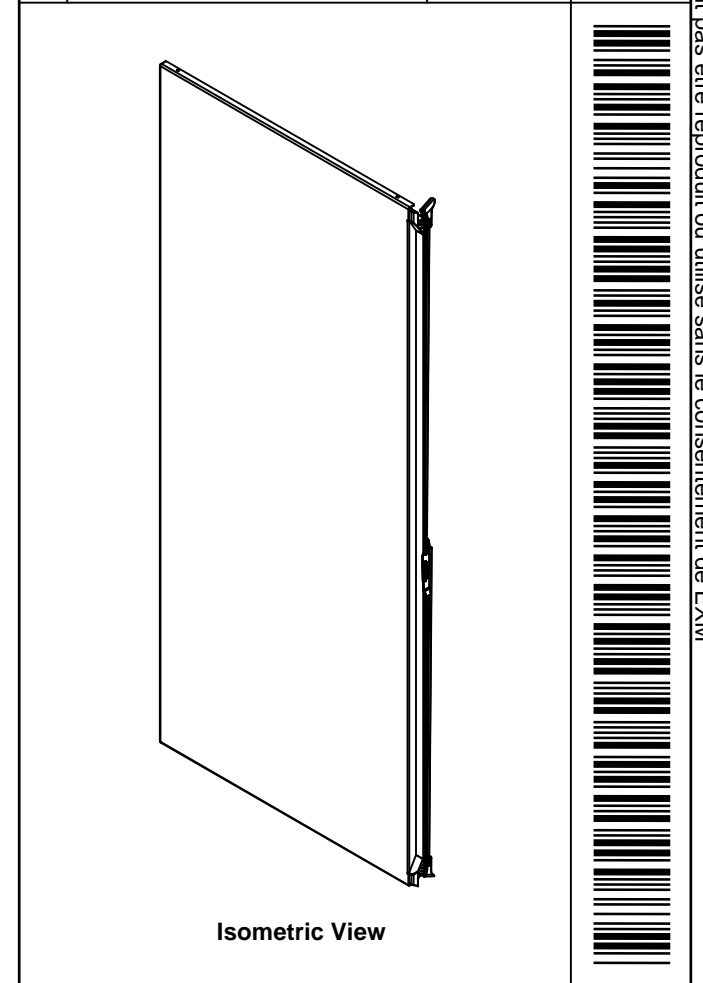

Qty	Part Name	Rev	Description
1	STK-P-02400S	0	Powder Paint (Asa-61 Grey / Smooth)
1	STK-G-03400	0	5500 DD Lower Flange Door Gasket
1	STK-G-03300	0	5500 DD Upper Flange Door Gasket
2	STK-Q-90045	0	Cabinet - Closing Bar End
2	STK-Q-45660-90	2	9500 DD - Flange Door Closing Bar
1	STK-K-50556	4	9500 DD - Flange Door Handle Assy
1	STK-K-20880	3	9500 - Flange Door Stiffener Assembly
1	STK-Q-16122	1	Stud M10 x 20mm
2	STK-Q-16405	6	Guide Stud - Small (No Paint Cap Required)
1	STK-G-00701	0	1" x 1/4" Self-Adhesive Neoprene Gasket
1	9500STDD907220FDG	0	9500DD 90" x 72" Flange Door Gasket
10	STK-Q-16055	1	M6 x 18mm Stud (No Paint Cap Required)
1	9500STDD907220FD-P	0	9500DD 90" x 72" Flange Door Part
5	STK-K-09860	7	Cabinet Hinge with Captive Pins
Qty	Part Name	Rev	Description
Parts List			



Tél: (450) 979-4373
Fax: (450) 979-4626
www.exmweb.com

Flatness
Aplatissement
Max 3.0mm

Projection

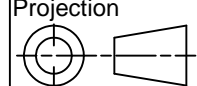

Customer Client		Date
Drawn By Dessiné Par	BoxCad: BoxCad	Date 08-Dec-21
Material Matière 12 Ga Cold Rolled A1008 CS Type B (2.5mm)		
Color Couleur	Asa-61 Grey	Finish Fini Smooth
Description 9500DD 90" x 72" Flange Door		Detail Rev.
Part Number Numéro Pièce 9500STDD907220FD		Rev. 3 0